

# SANITARY POSITIVE DISPLACEMENT PUMPS

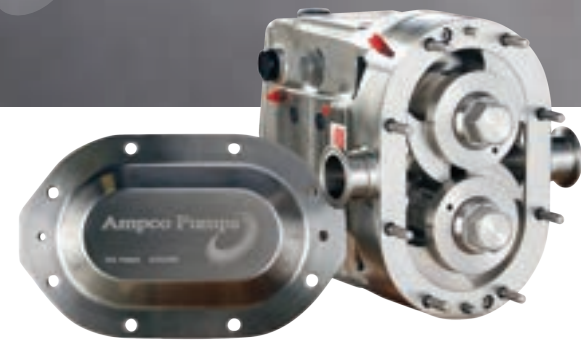

## ZP3 SERIES PATENTED DESIGN, LESS DOWNTIME

- Stainless steel gear case included.
- Front-loading seals are located closer to the product flow, offering improved CIP-ability with no disassembly required.
- Front-loading seals allow for ease-of-maintenance and reduced service time. No need to disconnect the pump from piping.
- EHEDG Certified and in conformance with 3A Sanitary Standards and ATEX Directive.
- Free drain design improves CIP-ability while maintaining maximum pump efficiency.
- Elimination of dead zones in shaft bore improves cleanability and increases seal life.

## ZP3A ASEPTIC SERIES ASEPTIC PUMP LINE

- Standard ZP3 seals
- Standard shafts, bodies and rotors
- Easy to install one piece cover gasket
- Fully CIP-able, no need to tear down pumps daily
- Aseptic fittings
- Standard ZP3 models can be easily converted to ZP3A design



## ZP1+ SERIES PATENTED DESIGN, EASY MAINTENANCE

Upgrade to a ZP1+ and change o-ring seals without disconnecting the pump from the piping system. Stainless steel gear case.



## ZP1/ZP2 SERIES

Includes a stainless steel gear case. Parts are 100% interchangeable with competing brands.



## ZP4 MOST EFFICIENT COMPACT SANITARY PUMP

Perfect for low-flow and dosing applications, front-loading seals.

- Non-galling Alloy 88 rotors
- Self-priming
- 304 stainless steel gear case
- 5 seal options available

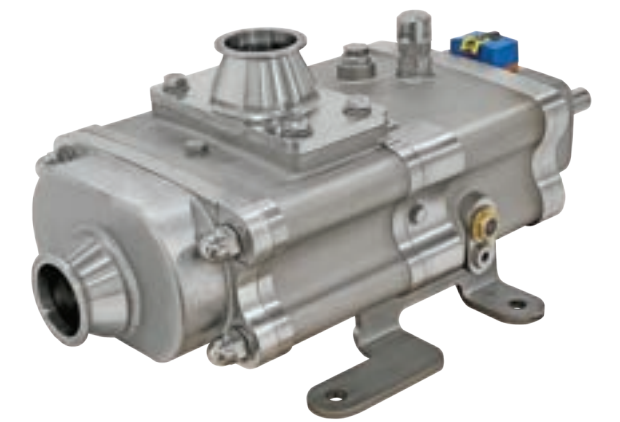

## BORNEMANN SLH SERIES - SANITARY TWIN SCREW PUMP

The SLH-5G is designed for gentle handling of soft solids and viscous products, with virtually pulsation-free operation. With standard and premium models to choose from, the SLH can efficiently pump up to 2.3" (58mm) suspended solids while maintaining visual and particle integrity of the media.

- All stainless steel construction (316L fluid end)
- Port sizes up to 6" (152mm)
- Viscosities up to 1,000,000 centipoise
- Reversible and dual-duty for process and CIP
- Handles up to 60% entrained air
- Max pressure 362 PSI/ 25 BAR

## AL SERIES ROTARY LOBE PUMPS

- Standard stainless steel gear case
- Up to 450 GPM/ 100 M<sup>3</sup>/ hr
- Viscosities up to 1,000,000 centipoise
- Front-loading seal, fully clean-in-place
- Competitively priced

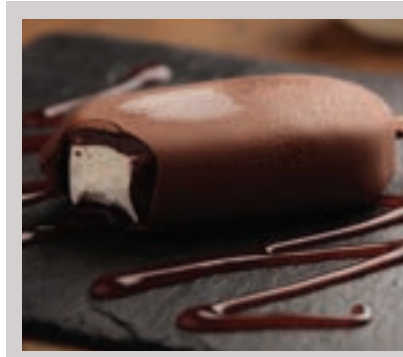
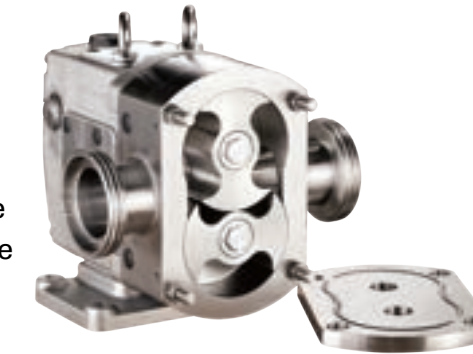

## COMMON APPLICATIONS

Dough, fats, fruit filling, icing, chocolate, cocoa butter, baby food, potato salad, relish, stews, butter, curds, soft cheese, yogurt, pet foods, sausage

# SANITARY CENTRIFUGAL PUMPS



## AC/AC+ SERIES ECONOMICAL PUMP

- 316L Stainless steel construction
- Stainless steel adapter
- Parts are 100% interchangeable with competing brands
- AC+ offers a unique shaft design
- One week delivery
- Economical favorite

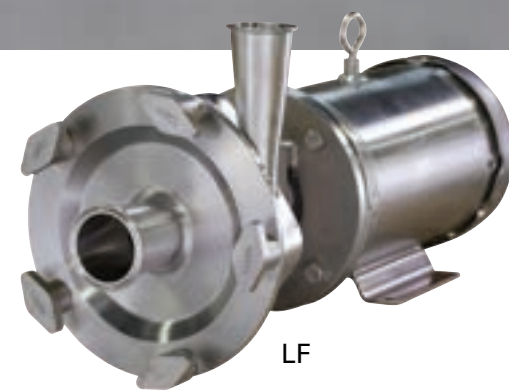

LF



LM

## LC/LD/LF/LM/LH SERIES HIGH EFFICIENCY PUMP

- LC – Single internal seal
- LD – Double seal
- LF – Front-loading seal design easily converted to double seal
- LM – Metric version of the LF
- LH- High pressure pump, inlet pressure up to 600 PSI/41.5 BAR



## SP SERIES LIQUID RING PUMP

- SP liquid ring pumps are ideally suited for CIP return applications and for handling products with entrained air
- Efficient option for emptying tanks and drums
- Perfect for shear sensitive products



## REMANUFACTURING

Remanufacture your existing Universal Series or ZP Series pump for a fraction of the cost of a new pump. Ampco offers remanufacturing in three locations – Milwaukee, Wisconsin, Stockton, California, and Herxheim Germany. Two week turnaround, one-year same as new factory warranty.

**New pump performance for 30% less.**

## PREMIUM ECONOMY PUMPS

Every PE pump is remanufactured and includes all new internal parts machined to new pump standards. Each pump is tested and comes with a full one-year factory warranty. Inventory is on the shelf ready to ship next day. Go to [ampcopumps.com](http://ampcopumps.com) to see current inventory. Stock can vary daily – please call for detailed information.

Standard upgrades on all remanufactured pumps

- 17-4ph shafts – provides three times the tensile strength of 316
- Stainless steel bearing retainers – prevents corrosion
- Helical gears – increased load-carrying capacity and reduced noise
- Powder coat paint - New Anodized Silver; better protection in a caustic environment and chip resistant

**New pump performance for 25% less.**

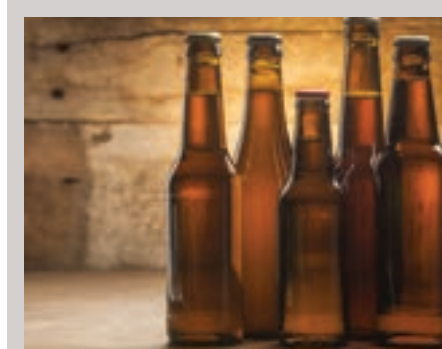

## COMMON APPLICATIONS

Fruit juice, mash, wine, beer, corn syrup, sugar solution, caustics, enzyme cleaner, lotion, soap, shampoo, ice cream, buttermilk, whey, salad oil, cooking oil, cologne, mouthwash, pharmaceuticals, biotech



# BREWING AND CELLAR

## ROLEC DH



### DESIGNED FOR SAFETY AND CONVENIENCE DURING HOP INDUCTION

- Three models available to meet the needs of all breweries
- The fully portable DH can be used on many fermenters and fits well in cramped cellars
- Not just for hops; use for spices, coffee, fruits and more
- Everything needed for pellet induction is contained on the ROLEC DH
- Gauges and sight glasses aid the user in monitoring induction and pressures
- All components are sanitary and CIP-able (no additional CIP pump is required)
- Improved aroma and flavor profile
- Faster tank turnover

Functional design under license of ROLEC PROZESS- UND BRAUTECHNIK GMBH, GERMANY, United States Patent no. 8,875,616

NOT JUST FOR HOPS

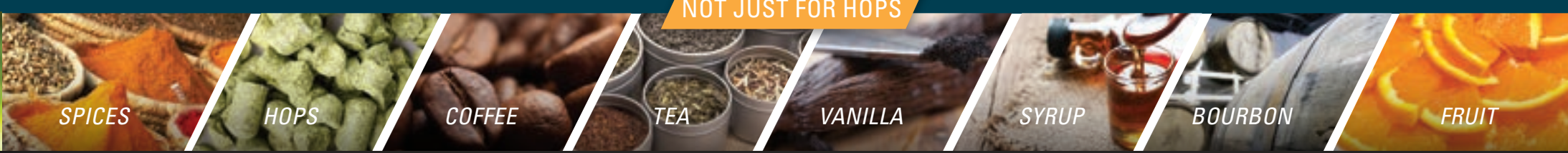

## CB+ CRAFT BREW PUMP



Ampco's CB+ features a sanitary internal seal design that keeps seal faces cooler and minimizes product buildup.

Developed specifically for the craft brewing industry, the CB+ Pump provides these advantages:

- The internal seal is submersed in product to promote cooling
- Pressure within the pump creates a higher closing force on seal faces to minimize product buildup
- Internal spring agitates wort solids to avoid pooling on seal face
- Conversion kits are available for competing C Series and AC+ pumps

## CELLAR CART FOR BEER & CIP



- Equipped with AC+ Series pump
- 2 wheeled robust stainless steel cart
- NEMA 4X VFD
- Solid polypropylene wheels

## WINE, MUST & YEAST CART

- 50' remote speed potentiometer
- 304 stainless steel gearcase
- Alloy 88 non-galling rotors
- 304 stainless steel cart
- NEMA 4X VFD
- 10" foam filled tires



# THE AMPCO ADVANTAGE

Ampco offers a complete line of centrifugal pumps, positive displacement pumps, dry blenders and powder mixers.

## DESIGN AND INNOVATION

The patented ZP3 and patented-design ZP1+ are designed to offer easy maintenance and reduce processing down time.

## NEED PARTS?

Having the best delivery times in the industry requires Ampco to maintain a tremendous parts inventory. Ampco guarantees the fit on all competing brand parts. Save time and money with Ampco's spare centrifugal and PD parts.

## DEDICATION TO CUSTOMERS

- Ampco offers premium upgrades, including a stainless steel gear case on each new positive displacement pump, while remaining cost competitive.
- Dedicated sales team and customer service staff
- The best delivery times in the industry
- Custom specifications are welcome
- AmpcoPumps.com provides technical information for distributor and customer success including a pump sizing program, product cross reference guide, manuals and literature.
- Ampco pumps are shipped globally through a growing distributor network.
- Both NEMA and IEC motors are available for domestic and international markets. Contact Ampco Pumps for more details.
- Manufactured, assembled, and tested in Glendale, WI since 1948

The Ampco inside sales team and application engineers are ready to assist with your next project.

www.ampcopumps.com  
U.S.A. - (800.737.8671 / info@ampcopumps.com)  
Europe & Asia - (+49 7276 5058515 / info@ampcopumps.de)



## Ampco Pumps Company

### COMPLETE LINE OF SANITARY PUMPS, MIXERS, AND BLENDERS

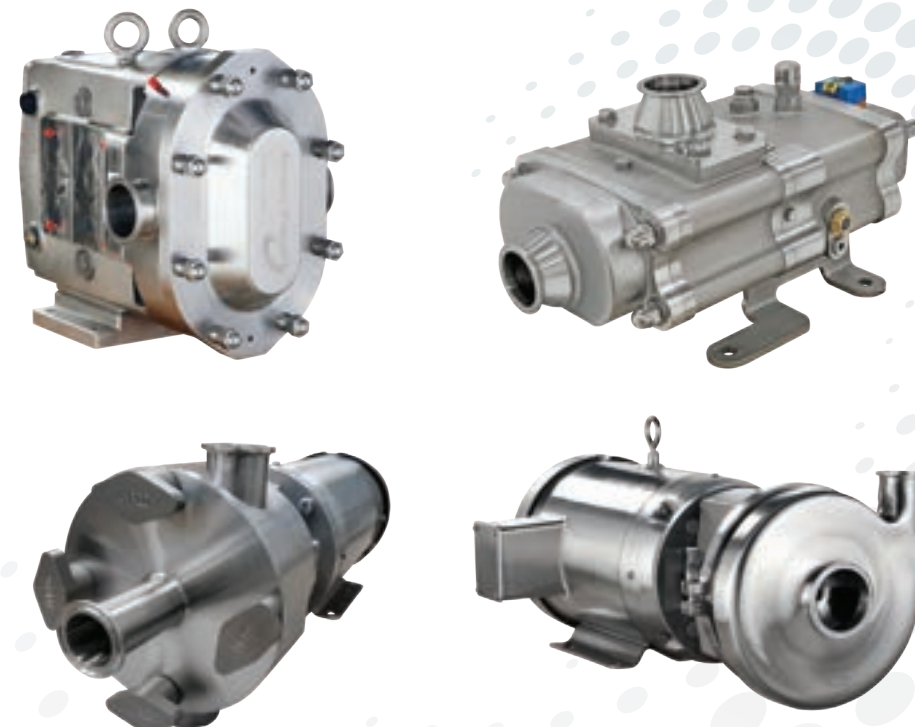

Ampco Pumps GmbH

AMPCO APPLIED PRODUCTS

AMPCO APPLIED PRODUCTS

## BLENDERS & MIXERS

### POWDER-MAX

- Five models available
- Mixer set inline – no batch size limits
- CIP-able

### JET-SHEAR

- High shear in tank mixing
- Multiple head options
- Multiple shaft lengths

### SHEAR-BLEND

- Efficient portable blending
- Ergonomic design
- Powered by the Ampco SBI

### SHEAR-MAX (HIGH SHEAR MIXER)

- Efficient high shear mixing
- Three sizes available
- Single and dual stage options

### SBH SERIES (SHEAR BLENDER)

- Multiple shearing teeth
- Moderate -to-high shear and good product flow

### SBI SERIES (SHEAR PUMP)

- Pumps and blends in a single stage
- Medium shear and great product flow

### SIMPLE-BLEND

- Five sizes available
- Removable 32Ra polished hopper
- 304 stainless steel cart

### DRY-BLEND

- Four models available
- Easy to operate
- All wetted components are 316L stainless steel

Ask about AAP trial, rental and leasing options.

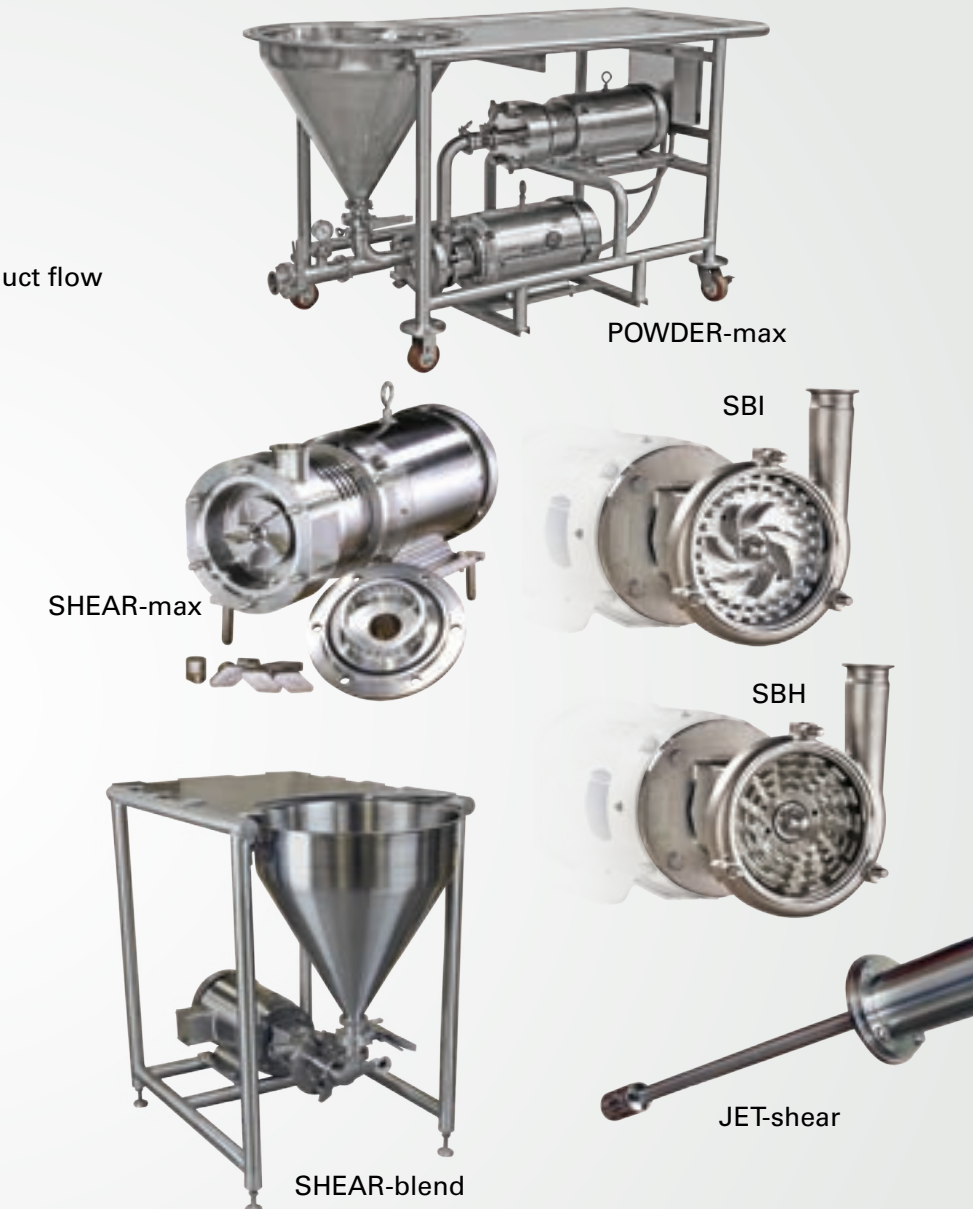

Ampco Pumps Company  
2045 W. Mill Road  
Glendale, WI 53209

## COMMON APPLICATIONS

Vegetable juice, coffee blends, flavor addition, salsa, pudding, chip dip, powdered egg, yogurt, eggnog, whey protein, toothpaste, lotion, shampoo, aspartame, dry milk, citric acid, honey, cough syrup, ointment, vitamin drink, coatings