

Index

A	Low pressure accessories -0-7 MPa-0-1000 psi	1
A1	Chemical metering valve	1
A2	Descaling pump - Detergent injection fitting	2
A3	Thermo protector valve - Inlet pressure reducer	3
A4	Low pressure guns -max.pres.2,4MPa-350psi	4
A5	Guns for chemicals	9
A6	SS Ball valves and foam guns	12
A7	Steam guns and lances	14
A8	Inlet water tank - Float valve	16
A9	Low pressure quick couplings	19
A10	Chemical suction strainers	20
A11	Water suction strainers	22
A12	Brushes	25
B	Valves	26
B1	Unloader valves -22MPa-3130psi	26
B2	Unloader valves -32 MPa-4550 psi	34
B3	Unloader valves -42 MPa-5975 psi	43
B4	Unloader valves -110 MPa-16000 psi	48
B5	Relief valves	51
B6	Pressure regulating valves	60
B7	Pressure regulating valves - compressed air control	63
B8	Flow regulator valves - Regulator valves	65
C	Spray Guns	68
C1	Spray guns up to 22MPa-3130 psi	68
C2	Spray guns up to 32 MPa -4550 psi	72
C3	Compensated spray guns and lances up to 42MPa-5975 psi	81
C4	Spray guns and lances up to 110 MPa-16200psi	82
C5	Weep spray guns	85
C6	Spray guns with lance hand grip/quick coupling	87
C7	Spray guns with complete lance/nozzle adapter	93
C8	Lance extensions for guns	99
D	Lances	105
D1	Insulated lances	105
D2	Lance extensions and tubes	114
D3	Double lances	116
E	Nozzles and nozzle holders	119
E1	Special holders without nozzle	119
E2	Special holders with nozzle	121
E3	Rotating nozzles	123
E4	Sand blasters	129
E5	1/8Npt M-1/4Npt M-M4-M6-M15-M16 nozzles	131
E6	Drain cleaning nozzles	137
F	Quick Couplings and Swivels	141
F1	Screw-type quick couplings	141
F2	Ball-type quick couplings	150
F3	Swivels	154
G	Chemical Venturi Injectors / Foamers	158
G1	Chemical Venturi injectors	158
G2	Foamers	162
H	Carwash Accessories	164
H1	Car Wash Accessories	164
I	Rotating special nozzles - Tank cleaners - Floor Cleaners	167
I1	Rotating Nozzles and Tank Cleaners	167
I2	Floor cleaners	181
J	Accessories	182
J1	Electrical accessories	182
J2	Miscellaneous accessories	187
K	Gear Reduction Boxes for Engine Motors	192
K1	Gear reduction boxes for petrol engines	192
	Nozzle Charts	194



The  tick indicates that **the item is available in stock.**



The number indicated under the box **refers to the pack size.**



Brand new item.



Components are in **compliance with applicable Directives.**



Components are in **compliance with Directive 2014/34/EU (ATEX).**



Components are in **compliance with Directive 2014/68/EU.**

All our components are in compliance with
Directive 2011/65/EU (RoHS)

Texts, drawings, images and all other material contained in this catalogue are the exclusive property of P.A. SpA, all forms of reproduction are strictly prohibited.

Technical data, i.e. dimension, weight, recommendations contained in this catalogue are for guidance only.

P.A. SpA reserves the right to modify the information contained on this catalogue at any time without notice.

RDY -90° CHEMICAL METERING VALVE

P/N	Couplings	Hose barb		Casing colour	Weight			
		mm	in		gr	oz		
29.0954.00	1/4 Bsp MM	7	0,28	Black	209	7,37	10	✓
29.0954.15	1/4 Bsp MM	7	0,28	Red	210	7,47	10	
29.0960.00	1/4 Bsp MM	-	-	Black	160	5,64	10	✓
Rated Pressure	28 bar - 2,8 MPa		400 psi					
Permissible Pressure	30 bar - 3 MPa		435 psi					
Rated Flow	10 l/min		2,6 USGpm					
Rated Temperature	40 °C		105 °F					
Panel fitting	17 mm		3/4 in					



RD5 - CHEMICAL METERING VALVE

P/N	Couplings	Hose barb		Col.	Weight			
		mm	in		gr	oz		
29.0980.00	1/4 Bsp MM	7	0,28	Blue	213	7,5	10	✓
29.0980.50	1/4 Bsp MM	7	0,28	Red	213	7,5	10	
Rated Pressure	28 bar - 2,8 MPa		400 psi					
Permissible Pressure	30 bar - 3 MPa		435 psi					
Rated Flow	10 l/min		2,6 USGpm					
Rated Temperature	40 °C		105 °F					
Panel fitting	15 mm		3/5 in					



Fluid quantity is adjusted through knob rotation

RD6 - TWIN INLET CHEMICAL VALVE

P/N	Hose barb		Weight			
	mm	in	gr	oz		
29.0900.00	7	0,28	62	2,19	10	✓
Rated Pressure	0,5 bar - 0,05 MPa		7,3 psi			
Rated Flow	1 l/min		0,26 USGpm			
Rated Temperature	60 °C		140 °F			
Panel fitting	14,5 mm		0,57 in			



Fluid mixing regulated through knob rotation

RD3 - CHEMICAL METERING VALVE

P/N	Couplings	Hose barb		Casing colour	Weight			
		mm	in		gr	oz		
29.0945.00	1/4 Bsp MM	7	0,28	Blue	175	6,2	10	✓
29.0945.06	1/4 Bsp MM	7	0,28	Black	170	6	10	
29.0945.16	1/4 Bsp MM	7	0,28	Red	174	6,14	10	
29.0952.00	1/4 Bsp MM	-	-	Blue	126	4,44	10	✓
29.0952.10	1/4 Bsp MM	-	-	Black	126	4,48	10	✓
Rated Pressure	28 bar - 2,8 MPa		400 psi					
Permissible Pressure	30 bar - 3 MPa		435 psi					
Rated Flow	10 l/min		2,6 USGpm					
Rated Temperature	40 °C		105 °F					
Panel fitting	15 mm		3/5 in					





Descaling pump - Detergent injection fitting

DA - DESCALING PUMP

P/N	Max. Voltage		Frequency		Flow rate		Weight			
	Volt	Hz	g/h	gr	oz					
12.5010.00	24 V	50 Hz	24	300	10,58	5				
12.5011.00	230 V	50 Hz	24	290	10,2	5				
Rated Pressure	0,5 bar - 0,05 MPa		7 psi							



PLUNGER METERING PUMP

P/N	Inlet	Outlet	Weight			
			gr	oz		
52.0000.00	1/2 Bsp M	1/2 Bsp M	2300	81	1	
Plastic pump head - Displacement 8,7 cc/rev						
Rated Pressure	20 bar - 2 MPa		290 psi			
Max. RPM			120 giri/min			



TANK AND HOSE FOR DESCALING PUMP **NEW**

P/N	Equipment	Hole size		Volume		Weight			
		mm	in	L	USg	gr	oz		
14.6501.00R	Tank	45	1,77	1,0	0,26	106	3,74	10	
14.6505.00	Tank	45	1,77	2,0	0,52	193	6,81	10	
14.6511.24	Plastic plug	22,5	0,88	-	-	10	0,35	10	
14.6512.85R	Plastic plug	45	1,77	-	-	10	0,35	10	





INJECTOR FITTING

P/N	Inlet	Outlet	Couplings	Weight			
				gr	oz		
21.0300.61R	3/4 Bsp M	1/2 Bsp M	2 × 1/8 Bsp F	113	3,99	10	
Rated Pressure	22 bar - 2,2 MPa		320 psi				
Rated Flow	30 l/min		8 USGpm				
Rated Temperature	90 °C		195 °F				
Material	Zinc plated steel						





It injects detergent into pump suction port

VT6 - THERMO PROTECTOR VALVE

P/N	Inlet	Operating temperatur.		Mat.	Weight		 	
		°C	°F		gr	oz		
60.0630.00	1/4 Bsp M	63	145	Brass	51	1,8	15	✓
60.0640.00	1/4 Bsp M	63	145	Sst Ai 303	51	1,8	15	
60.0630.15	1/4 Npt M	63	145	Brass	52	1,8	15	
60.0630.50	3/8 Bsp M	63	145	Brass	35	1,23	15	✓
60.0630.70	1/2 Bsp M	63	145	Brass	52	1,8	15	✓
Rated Pressure		10 bar - 1 MPa		145 psi				
Hose barb		7 mm		0,28 in				





VT.BP.1 - THERMO PROTECTOR / MAX.INLET PRESS.VALVE

P/N	Inlet	Operating temperatur.		Operat. press.		Weight		 	
		°C	°F	bar - MPa	psi	gr	oz		
28.0600.15	1/2 Bsp M	63	145	10 - 1	145	142	5,02	5	✓
28.0600.00	1/2 Npt M	63	145	10 - 1	145	142	5,02	5	
Rated Pressure		10 bar - 1 MPa		145 psi					
Hose barb		7 mm		0,28 in					



RP1 - INLET PRESSURE REDUCER

P/N	Working press.		Couplings	Weight		 	
	bar - MPa	psi		gr	oz		
28.0700.00	1,5 - 0,15	20	1/2 Bsp F	266	9,4	5	✓
Permissible Pressure	29 bar - 2,9 MPa		290 psi				
Rated Flow	32 l/min		8,5 USGpm				
Rated Temperature	70 °C		158 °F				





RB 35 - 50° C

P/N	Inlet	Nozzle type	Weight		10	
			gr	oz		
30.6200.00	+ sw. 1/2 Bsp F	Cone	446	15,73		
Rated Pressure	12 bar - 1,2 MPa		175 psi			
Rated Flow	50 l/min		13,2 USGpm			
Rated Temperature	50 °C		120 °F			
Material			PP+FG- Brass			
Seals material			FKM (Viton)*			
Casing colour			Blue			



RB 35 - 80° C - LOW PRESSURE GUN

P/N	Inlet	Nozzle type	Weight		10	
			gr	oz		
30.6250.00	+ sw. 1/2 Bsp F	Cone	454	16,01		
Rated Pressure	12 bar - 1,2 MPa		175 psi			
Rated Flow	50 l/min		13,2 USGpm			
Rated Temperature	80 °C		176 °F			
Material			PA+gf- Ai303			
Seals material			Epdm			
Casing colour			Blue			

Accessory specially designed for sanitization and for use with the following chemical principles: Sodium Hypochlorite.



RB 35 - ON-OFF DEVICE

P/N	Type	Rated Temper.		Material	Seals material	Weight			
		°C	°F			gr	oz		
30.6225.00	A	50	120	PP+FG - S.S.T. Ai.303	FKM (Viton)°	440	15,42	10	✓
30.6260.00	B	80	176	PA+gf- Ai303	Epdm	440	15,42	10	✓
Rated Pressure		12 bar - 1,2 MPa		175 psi					
Rated Flow		50 l/min		13,2 USGpm					
Inlet				1/2 Bsp F					
Outlet				1/2 Bsp F					
Casing colour				Blue					



RB 65 - AISI 316 ADJUSTABLE SPRAY PATTERN

P/N	Inlet	Nozzle Size	Weight				
			gr	oz			
30.6300.00	1/2 Bsp F	0 - 60	904	31,88	1	✓	
30.6310.00	+ sw.5 1/2 Bsp F	0 - 60	1008	35,55	1	✓	
Rated Pressure		24 bar - 2,4 MPa		350 psi			
Rated Flow		60 l/min		16 USGpm			
Rated Temperature		90 °C		195 °F			
Material		Stainless steel Ai316					
Casing colour		Blue					
Trigger casing		Gray					





RB 65 - ADJUSTABLE SPRAY PATTERN - BRASS PISTON

P/N	Casing colour	Trigger casing	Inlet	Nozzle Size	Weight		10	10
					gr	oz		
30.6400.00	Blue	Blue	1/2 Bsp F	0 - 60	944	33,3	10	✓
30.6500.00	White	Red	1/2 Bsp F	0 - 60	944	33,3	10	
30.6400.50	Blue	Blue	1/2 Npt F	0 - 60	944	33,3	10	
30.6425.00	Blue	Blue	+ sw.5 1/2 Bsp F	0 - 60	1060	37,39	10	✓
30.6425.50	Blue	Blue	+ sw.5 1/2 Npt F	0 - 60	1060	37,39	10	
30.6520.00	White	Blue	+ sw.5 1/2 Bsp F	0 - 60	1060	37,39	10	
Sst swivel pin.								
30.6430.00	-	-	13mm hose barb	-	66	2,33	10	
Swivel, suitable for RB65 -p/n. 30.6400.00								

Rated Pressure 24 bar - 2,4 MPa 350 psi
 Rated Flow 60 l/min 16 USGpm
 Rated Temperature 90 °C 195 °F
 Material Brass
 Piston Material Brass
 Casing colour Blue



RB 65 - ADJUSTABLE SPRAY PATTERN -SST.SHAFT

P/N	Casing colour	Trigger casing	Inlet	Nozzle type	Weight		10	10
					gr	oz		
30.6438.30	Red	Red	+ sw.5 1/2 Bsp F	0 - 60	1060	37,39	10	✓
+ Stainless Steel shaft								
30.6455.00	Blue	Blue	1/2 Bsp F	0 - 60	944	33,3	10	✓
30.6510.00	White	Blue	1/2 Bsp F	0 - 60	944	33,3	10	

Rated Pressure 24 bar - 2,4 MPa 350 psi
 Rated Flow 60 l/min 16 USGpm
 Rated Temperature 90 °C 195 °F
 Material Brass
 Piston Material Sst. Ai303



RB 65 - ADJUSTABLE SPRAY PATTERN- 100 L/MIN

P/N	Inlet	Nozzle Size	Weight		10	✓
			gr	oz		
30.6440.00	1/2 Bsp F	0 - 100	941	33,2	10	✓
30.6440.50	1/2 Npt F	0 - 100	941	33,2	10	
30.6445.00	+ sw.5 1/2 Bsp F	0 - 100	1060	37,39	10	✓
30.6445.50	+ sw.5 1/2 Npt F	0 - 100	1060	37,39	10	

Rated Pressure	24 bar - 2,4 MPa	350 psi
Rated Flow	100 l/min	26,5 USGpm
Rated Temperature	90 °C	195 °F
Material		Brass
Casing colour		Blue



RB 65-350 - 350 MM LANCE - ADJUSTABLE SPRAY PATTERN

P/N	Casing colour	Nozzle Size	Weight		5	✓
			gr	oz		
30.6465.00	Blue	0 - 60	2020	71,25	5	✓
30.6468.00	Red	0 - 60	2020	71,25	5	✓

Rated Pressure	24 bar - 2,4 MPa	350 psi
Rated Flow	60 l/min	16 USGpm
Rated Temperature	90 °C	195 °F
Inlet		1/2 Bsp F
Length	350 mm	13,8 in.
Material		Brass



RB 65 - ON-OFF DEVICE



P/N	Inlet	Outlet	Mat.	Weight		10	✓
				gr	oz		
30.6450.00	1/2 Bsp F	1/2 Bsp F	Brass	1042	36,75	10	✓
30.6453.00	+ sw.5 1/2 Bsp F	1/2 Bsp F	Brass	1154	40,7	10	✓
30.6350.00	+ sw.5 1/2 Bsp F	1/2 Bsp F	Sst Ai 316L	1154	40,7	10	✓

Rated Pressure	24 bar - 2,4 MPa	350 psi
Rated Flow	100 l/min	26,5 USGpm
Rated Temperature	90 °C	195 °F
Casing colour		Blue





EXTENSION RB 65 WITH ON-OFF DEVICE

P/N	Length		Inlet	Outlet	Weight			
	mm	in.			gr	oz		
30.6456.40	400	15,7	1/2 Bsp M	1/2 Bsp F	660	23,28	1	
30.6456.80	800	31,4	1/2 Bsp M	1/2 Bsp F	1138	40,14	1	
Rated Pressure	24 bar - 2,4 MPa			350 psi				
Rated Flow	100 l/min			26,5 USGpm				
Rated Temperature	43 °C			109 °F				
Material	Stainless steel							



CP12 - GUN FOR CHEMICALS 2,5 MPA

P/N	Mat.	Trigger	Weight			
			gr	oz		
15.0003.12R	PP+ viton	Blue	128	4,51	10	✓
15.0003.11R	PP+ Nbr	Red	128	4,51	10	
15.0013.12R	PP+viton+Aisi 316	Grey	131	4,62	10	✓

Suitable for use with very aggressive chemicals

Rated Pressure	25 bar - 2,5 MPa	365 psi
Rated Flow	70 l/min	18,5 USGpm
Rated Temperature	50 °C	120 °F
Inlet		1/2 Bsp F
Outlet		1/2 Bsp F



CP12 - GUN FOR CHEMICALS 6 MPA

P/N	Mat.	Trigger	Weight			
			gr	oz		
15.0003.10R	Pa66 reinf.	Yellow	162	5,7	10	✓

Rated Pressure	60 bar - 6 MPa	870 psi
Rated Flow	70 l/min	18,5 USGpm
Rated Temperature	50 °C	120 °F
Inlet		1/2 Bsp F
Outlet		1/2 Bsp F



SUCTION STRAINER FOR CP12 GUN

P/N	Hole size		Weight			
	mm	in	gr	oz		
13.0003.46R	18,2	0,72	2	0,07	10	

Rated Pressure	40 bar - 4 MPa	580 psi
Rated Flow	70 l/min	18,5 USGpm
Rated Temperature	60 °C	140 °F
Filtration parameter	25 mesh	700 µm
Material		PP + FG
Gun type		CP 12



CP600 - CP12+600 MM PVC LANCE - 110° FLAT FAN NOZZLE

P/N	Nozzle Size	Weight			
		gr	oz		
15.0006.01R	02	232	8,18	10	
15.0006.02R	03	230	8,11	10	✓
15.0006.03R	04	232	8,18	10	
15.0006.04R	045	236	8,32	10	
15.0006.05R	06	231	8,15	10	
15.0006.06R	08	234	8,25	10	

Rated Pressure	15 bar - 1,5 MPa	217 psi
Rated Temperature	50 °C	120 °F
Length	600 mm	23,6 in.
Gun type		CP12 PP+viton
Tube type		Pvc
Nozzle type		Flat fan
Inlet		1/2 Bsp F



Supplied with 110° fan nozzle in thermoplastic material - p/n° 2.0150.01-07



CP1200 - CP12 +1200 MM PVC LANCE - 110° FLAT FAN NOZZLE

P/N	Nozzle Size	Weight		10	10
		gr	oz		
15.0012.02R	03	321	11,33	10	
15.0012.04R	045	314	11,08	10	

Rated Pressure	15 bar - 1,5 MPa	217 psi
Rated Temperature	50 °C	120 °F
Length	1200 mm	47,2 in.
Gun type		CP12 PP+viton
Tube type		Pvc
Nozzle type		Flat fan
Inlet		1/2 Bsp F

Supplied with 110° fan nozzle in thermoplastic material - p/n° 2.0150.01-07



CP600 - CP12 + 600 MM PVC LANCE - CONE NOZZLE

P/N	Nozzle Size	Weight		10	10
		gr	oz		
15.0006.51R	025	240	8,5	10	
15.0006.52R	035	240	8,5	10	
15.0006.53R	05	234	8,25	10	

Rated Pressure	25 bar - 2,5 MPa	356 psi
Rated Temperature	50 °C	120 °F
Length	600 mm	23,6 in.
Gun type		CP12 PP+viton
Tube type		Pvc
Nozzle type		Cone
Inlet		1/2 Bsp F

Supplied with Stainless steel cone nozzle - p/n° 2.0150.51-55



CPA600 - 600 MM SST. LANCE - 110° FLAT FAN NOZZLE

P/N	Nozzle Size	Weight		10	10
		gr	oz		
15.0216.07R	01	284	10,02	10	
15.0216.01R	02	282	9,95	10	✓
15.0216.02R	03	281	9,91	10	✓

Rated Pressure	15 bar - 1,5 MPa	217 psi
Rated Flow	30 l/min	8 USGpm
Rated Temperature	50 °C	120 °F
Length	600 mm	23,6 in.
Gun type		CP12-04
Tube type		Stainl. steel
Nozzle type		Flat fan
Inlet		1/2 Bsp F

Supplied with 110° fan nozzle in thermoplastic material - p/n° 2.0150.01-07



CPAT 2000 SST. TELESC.LANCE - 110° 03 FLAT FAN NOZZLE

P/N	Nozzle Size	Weight		10
		gr	oz	
15.0030.02R	03	969	34,18	10
Rated Pressure	15 bar - 1,5 MPa	217 psi		
Rated Flow	30 l/min	8 USGpm		
Rated Temperature	50 °C	120 °F		
Length	1125-1965 mm	44,3-77 in.		
Gun type		CP12-04		
Tube type		Stainl. steel		
Nozzle type		Flat fan		
Inlet		1/2 Bsp F		



Supplied with 110° fan nozzle in thermoplastic material - p/n° 2.0150.01-07

TW1 - 2-DETERGENT LANCE

P/N	Seals material	Nozzle Size	Weight		1
			gr	oz	
15.0008.00R	FKM (Viton)°	-	322	11,36	1
15.0008.01R	FKM (Viton)°	Flat 03- Cone 035	328	11,57	1
15.0008.50R	Epdm	-	321	11,32	1
15.0008.51R	Epdm	Flat 03- Cone 035	329	11,6	1
Rated Pressure	10 bar - 1 MPa	145 psi			
Rated Flow	30 l/min	8 USGpm			
Rated Temperature	50 °C	120 °F			
Length	630 mm	24,86 in.			
Tube type		Stainl. steel			
Nozzle type		Plast.flat fan+ ss.cone			
Inlet		2 x 1/8 Bsp F			



Supplied with 110° fan nozzle in thermoplastic material - p/n° 2.0150.01-07

LANCE COUPLINGS AND HOSE BARB FOR CP 600 / CP 12 / RB35/65

P/N	Type	Outlet	Mat.	Weight		10
				gr	oz	
12.0010.18R	Nipple	1/4 Bsp M	Brass	49	1,74	10
13.0003.60R	Nipple	1/4 Bsp F	PP	6	0,2	5
2.0010.01R	Hose barb	8mm hose barb	Nic.pl.brass	51	1,8	5
2.0010.02R	Hose barb	10mm hose barb	Nic.pl.brass	55	1,9	5
13.0003.38R	Hose barb	13mm hose barb	PPL	8	0,28	5
13.5032.19R	Hose barb	19mm hose barb	PPL	25	0,9	10
13.0003.50R	Seal washer	--	PP	5	0,2	5



Sealing washer 1/2"

Inlet 1/2 Bsp M



RLD SHOWER HEAD

P/N	Inlet	Weight		1	✓
		gr	oz		
29.1200.00R	1/2 Bsp M	670	23,6	1	✓
Rated Pressure	5 bar - 0,5 MPa			73 psi	
Rated Flow	18 l/min			4,68 USGpm	
Rated Temperature	60 °C			140 °F	
Material	Chrome plated brass				



RPS BALL VALVE STAINLESS STEEL

P/N	Material	Hand Grip	Trigger	Type	Weight		4	✓
					gr	oz		
29.1000.00	Stainless steel 303	Handle	Blue	A	750	26,45	4	
29.1030.00	Stainless steel 303	Butterfly	Blue	D	750	26,45	4	✓
29.1050.00	Stainless steel Ai316	Handle	Red	B	750	26,45	4	
29.1080.00	Stainless steel Ai316	Butterfly	Red	C	750	26,45	4	✓
Rated Pressure	24 bar - 2,4 MPa			350 psi				
Rated Flow	80 l/min			21 USGpm				
Rated Temperature	90 °C			195 °F				
Inlet				1/2 Bsp F				
Outlet				1/2 Bsp F				
Hole size	15 mm			0,59 in				

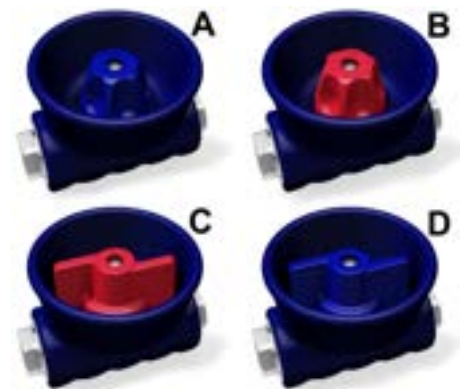

RL 60 - SST FOAM GUN -SLOW OFF SYSTEM

P/N	Inlet	Outlet	Col.	Weight		10	✓
				gr	oz		
30.3170.00	+ sw.5 1/2 Bsp F	1/2 Bsp F	Blue	616	21,73	10	✓
Inlet with swivel							
30.3170.40	+ sw.5 1/2 Bsp F	1/2 Bsp F	Red	616	21,73	10	
Inlet with swivel							
30.3170.58	+ sw.5 1/2 Bsp F	1/2 Bsp F	Blue	616	21,73	10	
Inlet with swivel Teflon seat							
Rated Pressure	60 bar - 6 MPa			870 psi			
Permissible Pressure	65 bar - 6,5 MPa			950 psi			
Rated Flow	60 l/min			16 USGpm			
Rated Temperature	100 °C			210 °F			
Material	Stainless steel						



RL 60 +SW GUN +ARS- B- BALL QUICK COUPLING

P/N	Inlet	Outlet	Weight			
			gr	oz		
30.3190.00	+ sw. 1/2 Bsp F	ARS 178 B	689	24,3	2	✓
Inlet with swivel						
Rated Pressure	60 bar - 6 MPa		870 psi			
Permissible Pressure	65 bar - 6,5 MPa		950 psi			
Rated Flow	60 l/min		16 USGpm			
Rated Temperature	100 °C		210 °F			
Material	Stainless steel					



FOAM LANCE X ARS 178 - STAINLESS STEEL

P/N	Length		Inlet	Col.	Outlet	Nozzle material	Type	Weight			
	mm	in.						gr	oz		
40.0280.00	200	8	ARS 178 "A"	Black	--	Brass	A	320	10,44	2	
40.0280.50	200	8	ARS 178 "A"	Blue	1/2 Bsp F	--	B	320	10,44	2	✓
40.0280.60	200	8	ARS 178 "A"	Blue	--	Brass	C	320	10,44	2	
40.0280.80	200	8	ARS 178 "A"	Blue	--	St. steel	D	296	10,44	2	
40.0290.00	25	1	ARS 178 "A"	Black	--	Brass	E	77	2,72	2	
40.0290.50	25	1	ARS 178 "A"	Blue	1/2 Bsp F	--	F	77	2,72	2	
40.0290.60	25	1	ARS 178 "A"	Blue	--	Brass	G	143	5,04	2	
40.0290.80	25	1	ARS 178 "A"	Blue	--	St. steel	H	128	4,51	2	
40.0294.31	25	1	ARS 178 "A"	White	--	Brass	L	128	4,51	5	✓
40.0292.51	25	1	ARS 178 "A"	White	--	St. steel	M	128	4,51	5	✓
40.0296.30	25	1	ARS 178 "A"	Yellow	1/4 Npt F	Pom	N	128	4,51	5	
Nozzle 60.30											
40.0296.50	25	1	ARS 178 "A"	Blue	1/4 Npt F	St. steel	P	135	4,76	5	✓
Nozzle 25.40											
Rated Pressure	125 bar - 12,5 MPa		1825 psi								
Permissible Pressure	140 bar - 14 MPa		2025 psi								
Rated Flow	50 l/min		13,2 USGpm								
Rated Temperature	90 °C		195 °F								
Couplings	Stainless steel Ai303										
Tube type	Stainl. steel										
Nozzle type	50°-200										

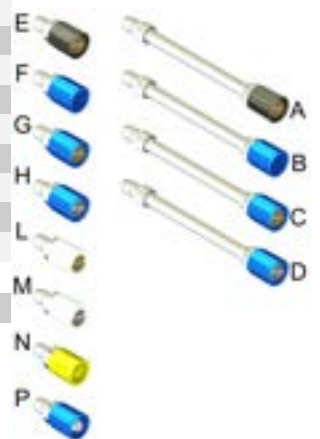

Lances with tip protector and nozzle holder.



RV 23 STEAM GUN

P/N	Switch	Elect.Connec.	Weight		
			gr	oz	
30.6030.00	Reed Switch	Micro-fit 2 pins M	460	16,22	10
30.6100.00	Reed Sw.+ 1 lamp button	Micro-fit 4 pins M	468	16,51	10
30.6150.00	Reed Sw.+ 2 lamp buttons	Micro-fit 6 pins M	487	17,2	10
Rated Pressure	10 bar - 1 MPa	145 psi			
Steam Rated Flow	35 kg/h	77 lb/h			
Rated Temperature	180 °C	356 °F			
Inlet		1/4 Bsp F			
Outlet		1/4 Bsp F			
Max. Voltage		24V AC			
Max. Curr. Strength		0,4 A			
Degree of Protection		IPX 3			
Protection Class		III			
Couplings		PG 21 mm			



RV 23 FREE FLOW STEAM GUN

P/N	Switch	Elect.Connec.	Weight		
			gr	oz	
30.6020.00	Reed Sw.+ 1 lamp button	Micro-fit 4 pins M	455	16,05	10
Rated Pressure	10 bar - 1 MPa	145 psi			
Steam Rated Flow	35 kg/h	77 lb/h			
Rated Temperature	180 °C	356 °F			
Inlet		1/4 Bsp F			
Outlet		1/4 Bsp F			
Max. Voltage		24V AC			
Max. Curr. Strength		0,4 A			
Degree of Protection		IPX 3			
Protection Class		III			
Couplings		PG 21 mm			



RV 23 STEAM GUN+ AR3/23 B M22 EX

P/N	Switch	Elect.Connec.	Weight		
			gr	oz	
30.6130.00	Reed Switch	Micro-fit 2 pins M	594	20,95	10
30.6145.00	Reed Sw.+ 1 lamp button	Micro-fit 4 pins M	468	16,5	10
Rated Pressure	10 bar - 1 MPa	145 psi			
Steam Rated Flow	35 kg/h	77 lb/h			
Rated Temperature	180 °C	356 °F			
Inlet		1/4 Bsp F			
Outlet		AR 3/23 B M22 ex			
Max. Voltage		24V AC			
Max. Curr. Strength		0,4 A			
Degree of Protection		IPX 3			
Protection Class		III			
Couplings		PG 21 mm			



RV 23 FREE FLOW STEAM GUN+ AR3/23 B M22 EX

P/N	Switch	Elect.Connec.	Weight			
			gr	oz		
30.6140.00	Reed Sw.+ 1 lamp button	Micro-fit 4 pins M	598	21,09	10	
Rated Pressure	10 bar - 1 MPa		145 psi			
Steam Rated Flow	35 kg/h		77 lb/h			
Rated Temperature	180 °C		356 °F			
Inlet			1/4 Bsp F			
Outlet		AR 3/23 B M22 ex				
Max. Voltage			24V AC			
Max. Curr. Strength			0,4 A			
Degree of Protection			IPX 3			
Protection Class			III			
Couplings			PG 21 mm			



EXTENSIONSK7 K /S3 -AR3A ES.M22 QUICK COUPLING-1/4M BSP

P/N	Type	Length		Hand Grip	Weight			
		mm	in.		gr	oz		
40.2525.00	Straight	250	9,85	S7 k	212	7,48	20	
40.2525.40	Bent	250	9,85	S7 k	214	7,55	20	
40.2550.00	Straight	450	17,72	S3	378	13,33	20	
40.2550.40	Bent	450	17,72	S3	378	13,33	20	
40.2590.00	Straight	900	35,43	S3	572	20,17	20	
40.2605.00	Straight	1050	41,33	S3	640	22,57	20	
Rated Pressure	250 bar - 25 MPa				3650 psi			
Permissible Pressure	280 bar - 28 MPa				4050 psi			
Rated Flow	40 l/min				10,5 USGpm			
Rated Temperature	160 °C				320 °F			
Inlet					AR 3 A M22 hex			
Outlet					1/4 Bsp M			
Material					Stainless steel			





TANK - 4 LITERS

P/N	Type	Weight		10	✓
		gr	oz		
28.2000.00	w/o ports	480	16,5	25	✓
28.2000.10	1 port	475	16,75	25	✓
28.2000.15	2 ports	470	16,58	10	
28.2000.20	3 ports	480	16,5	10	

Tank	4 L	1,05 USg
Volume	5,6 L	1,48 USg
Rated Temperature	60 °C	140 °F
Material		PPL



TANK - 4 LITERS WITH FLOAT VALVE / HOSE BARB

P/N	Inlet	Hose barb		Type	Weight		1	✓
		mm	in		gr	oz		
28.2020.00	3/8 Bsp M	20	0,78	Straight	834	29,42	1	✓
Straight 20 mm hose barb								
28.2020.10	3/8 Bsp M	20	0,78	Bent	844	29,77	1	✓
Bent 20 mm hose barb								

Supplied with : Suction strainer - 3/8 Bsp M brass float valve - Safety hose outlet 13mm - 20mm hose barb



TANK - 4 LITERS WITH FLOAT VALVE -OUTLET 1/2 BSP M

P/N	Inlet	Outlet	Weight		1
			gr	oz	
28.2052.00	3/4 Bsp M	1/2 Bsp M	611	21,55	1
Plastic float valve					

Supplied with : Suction strainer- 3/4 Bsp M float valve- Outlet 1/2 Bsp M





ACCESSORIES FOR TANKS

P/N	Inlet	Outlet	Type	Weight		10	✓
				gr	oz		
28.2021.00R	3/8 Bsp M	13mm hose barb	Elbow	7	0,25	10	✓
29.0171.31R	3/8 Bsp F	--	Nut	10	0,4	50	✓
12.2023.00R	1/2 Bsp M	20mm hose barb	Elbow	14	0,49	10	✓
2.0090.15R	1/2 Bsp M	1/2 Bsp M	Nipple	12	0,42	5	
13.5031.84R	1/2 Bsp M	1/2 Bsp M	Nipple	14	0,49	10	
13.0003.37R	1/2 Bsp M	1/4 Bsp M	Nipple	25	0,9	10	





SUCTION STRAINER FOR TANK

P/N	Couplings	Weight				
		gr	oz			
28.0055.00	3/8 Bsp M+O-ring	70	2,4	25		
28.2027.23	1/2 Bsp F	33	1,16	25	✓	
28.0080.23	3/8 Bsp M	70	2,4	25	✓	
26.0373.21R	M 18 × 1 M	70	2,4	25		
Filtration parameter		46 mesh		300 µm		
Material				Brass + Sst net		





RGP - PLASTIC FLOAT VALVE

P/N	Inlet	Weight				
		gr	oz			
29.0150.00	3/4 Bsp M	78	2,75	25	✓	
Rated Pressure		10 bar - 1 MPa		145 psi		
Rated Temperature		60 °C		140 °F		

Flow: @1 bar > 28,5 Lpm -14psi >7,5 USGpm- @2 bar > 30 Lpm -28psi > 8 USGpm





RG 30 - PLASTIC FLOAT VALVE

P/N	Inlet	Weight				
		gr	oz			
29.0220.00	3/8 Bsp M	100	3,53	25	✓	
29.0220.20	1/2 Bsp M	102	3,6	25	✓	
29.0220.70	3/4 Bsp M	108	3,81	25	✓	
Rated Pressure		10 bar - 1 MPa		145 psi		
Rated Temperature		60 °C		140 °F		

Flow: @1 bar > 28 Lpm-14psi >7,4USGpm- @2 bar > 40 Lpm-29psi >10,5USGpm



RGO - BRASS FLOAT VALVE

P/N	Inlet	Type	Weight				
			gr	oz			
29.0160.00	3/8 Bsp M	A	284	10,02	25	✓	
29.0160.80	3/8 Bsp M	A	250	8,82	25		
Short floater arm							
29.0160.10	1/2 Bsp M	A	306	10,8	25	✓	
29.0160.30	1/2 Bsp F	A	311	10,97	25	✓	
29.0160.20	3/4 Bsp M	A	363	12,8	25	✓	
29.0160.90	3/8 Bsp M	B	267	9,42	40		
Float retainer with external screw - old PA type							
29.0160.94	3/4 Bsp M	B	325	11,46	40	✓	
Float with external screw -PA old type -Without nut or washer							
29.0182.00	3/8 Bsp M	C	284	10,02	25		
Plastic arm							
29.0182.20	3/4 Bsp M	C	341	12,05	25		
Plastic arm							
Rated Pressure			10 bar - 1 MPa		145 psi		
Rated Temperature			60 °C		140 °F		

Flow: @1 bar > 20 Lpm-14psi >5,3USGpm- @2 bar > 29 Lpm-28psi > 7,5USGpm

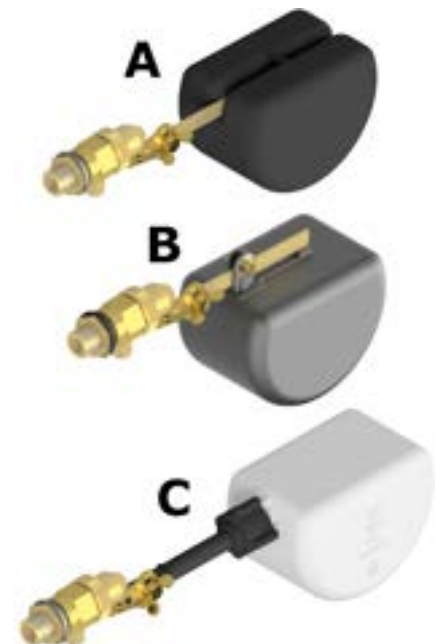



RGO - BRASS FLOAT VALVE + 17MM HOSE BARB + STRAINER

P/N	Hose barb		Weight		25	✓
	mm	in	gr	oz		
29.0160.35	17	0,67	404	14,25	25	✓

Rated Pressure 10 bar - 1 MPa 145 psi
 Rated Temperature 60 °C 140 °F

Flow: @1 bar > 20 Lpm -14psi >5,3USGpm- @2 bar > 29 Lpm -28psi > 7,5USGpm



RG60 - BRASS FLOAT VALVE

P/N	Inlet	Weight		25	✓
		gr	oz		
29.0280.00	1/2 Bsp M	392	13,83	25	✓
29.0280.20	3/4 Bsp M	443	15,63	25	✓

Rated Pressure 6 bar - 0,6 MPa 87 psi
 Rated Temperature 60 °C 140 °F

Flow: @1 bar > 42 Lpm-14psi >11,1USGpm-@2 bar > 60 Lpm-29psi > 16USGpm



BALL QUICK COUPLING FOR WATER SUCTION Ø22 MM

P/N	Inlet	Type	Weight		25	✓
			gr	oz		
28.0250.00	1/2 Bsp M	B	157	5,54	25	✓
28.0250.30	3/4 Bsp M	B	177	6,24	25	✓
28.0250.40	3/4 Bsp F	B	162	5,71	25	✓
28.0255.31R	17-19mm hose barb	A	66	2,33	25	✓
Rated Pressure	10 bar - 1 MPa				145 psi	
Rated Flow	24 l/min				6,3 USGpm	
Rated Temperature	90 °C				195 °F	

Pin Ø22 mm



SCREW QUICK COUPLING FOR WATER SUCTION

P/N	Inlet	Outlet	Weight		5	✓
			gr	oz		
28.0030.00R	1/2 Bsp M	1/2 Bsp M	105	3,7	5	✓
Rated Pressure	10 bar - 1 MPa				145 psi	
Rated Flow	80 l/min				21 USGpm	
Rated Temperature	90 °C				195 °F	

3/4 Bsp nut



STRAINER + HOSE BARB

P/N	Inlet	Hose barb		Weight		10	✓
		mm	in	gr	oz		
28.0035.00	3/8 Bsp M	17	0,7	82	2,89	10	✓
28.0040.00	1/2 Bsp M	17	0,7	82	2,89	10	✓
28.0047.00	3/8 Bsp M	19	0,74	86	3	10	✓
28.0042.00	1/2 Bsp M	19	0,74	92	3,24	10	✓
Rated Pressure	8 bar - 0,8 MPa				115 psi		
Rated Flow	20 l/min				5,2 USGpm		
Rated Temperature	60 °C				140 °F		

3/4 Bsp nut





PLASTIC CHEMICAL STRAINER

P/N	1 - Hose barb		2 - Hose barb		Mat.	Weight			
	mm	in	mm	in		gr	oz		
28.1010.00	6	0,24	8	0,32	PP+ brass	20	0,7	50	✓
28.1010.30	6	0,24	8	0,32	PP+ Sst.	18	0,63	10	✓
Rated Temper.			40 °C				104 °F		
Filtration parameter			51 mesh				355 µm		



PLASTIC CHEMICAL STRAINER WITH CHECK VALVE

P/N	1 - Hose barb		2 - Hose barb		Mat.	Weight			
	mm	in	mm	in		gr	oz		
28.1000.00	6	0,24	8	0,32	PP+ brass	22	0,77	50	✓
28.1000.30	6	0,24	8	0,32	PP+ Sst.	20	0,71	10	✓
Rated Temper.			40 °C				104 °F		
Filtration parameter			51 mesh				355 µm		



FSR- PLASTIC CHEMICAL STRAINER WITHOUT MESH

P/N	1 - Hose barb		2 - Hose barb		Mat.	Weight			
	mm	in	mm	in		gr	oz		
28.1045.00	6	0,24	8	0,31	PP+ brass	21	0,74	25	✓
Rated Flow			1,5 l/min				0,4 USGpm		
Rated Temper.			40 °C				104 °F		
Filtration parameter			51 mesh				355 µm		



FSR- PLASTIC CHEMICAL STRAINER WITH CHECK VALVE

P/N	1 - Hose barb		Hose barb		Mat.	Weight			
	mm	in	mm	in		gr	oz		
28.1035.00	6	0,24	8	0,32	PP+ brass	22	0,77	25	✓
Rated Flow			1,5 l/min				0,4 USGpm		
Rated Temper.			40 °C				104 °F		
Filtration parameter			51 mesh				355 µm		



CHEMICAL STRAINER WITH STAINLESS STEEL NET

P/N	Hose barb		Mat.	Type	Weight				
	mm	in			gr	oz			
29.0915.00R	7	0,27	Sst.+ brass	B	18	0,6	25	✓	
28.1018.00R	8	0,31	Sst. Ai 304 L	A	11	0,4	5	✓	
28.1018.60R	8	0,31	Sst Ai 316L	A	11	0,4	5		
Filtration parameter			46 mesh				300 µm		



SST SUCTION CHEMICAL STRAINER

P/N	Hose barb		Mat.	Type	Weight		5	5
	mm	in			gr	oz		
28.1015.00	7	0,27	Sst. Ai 304 L	A	5	0,2	5	✓
28.1015.60	7	0,27	Sst Ai 316L	B	5	0,2	5	✓
Filtration parameter			35 mesh	500 µm				



SST STRAINER WITH CHECK VALVE

P/N	Hose barb		Mat.	Weight		25	✓
	mm	in		gr	oz		
28.0050.00	7	0,27	Sst.+ brass	40	1,41	25	✓
Filtration parameter			46 mesh	300 µm			





F5 - PLASTIC SUCTION STRAINER

P/N	Inlet	Outlet	Weight				
			gr	oz			
28.0300.00	1/2 Bsp F	1/2 Bspt M	172	6,07	20		✓
28.0300.20	1/2 Bsp F	1/2 Bsp F	140	4,94	20		✓
Rated Pressure	10 bar - 1 MPa				145 psi		
Rated Flow	(Dp 0.25 bar) 30 l/min				8 USGpm		
Rated Temperature	40 °C				105 °F		
Filtration parameter	50 mesh				300 µm		



F5 B- PLASTIC STRAINER WITH BYPASS

P/N	Inlet	Outlet	Weight				
			gr	oz			
28.0350.00	1/2 Bsp F	1/2 Bspt M	184	6,5	20		✓
28.0350.20	1/2 Bsp F	1/2 Bsp F	145	5,11	20		✓
Rated Pressure	10 bar - 1 MPa				145 psi		
Rated Flow	(Dp 0.25 bar) 30 l/min				8 USGpm		
Rated Temperature	40 °C				105 °F		
Bypass					1/4 Bsp F		
Filtration parameter	50 mesh				300 µm		



F5 BN - REINFORCED PLASTIC STRAINER WITH BYPASS

P/N	Mat.	Weight				
		gr	oz			
28.0360.00	Pa66 reinf.	208	7,34	20		✓
Rated Pressure	10 bar - 1 MPa				145 psi	
Rated Flow	(Dp 0.25 bar) 30 l/min				8 USGpm	
Rated Temperature	60 °C				140 °F	
Inlet					1/2 Bsp F	
Outlet					1/2 Bspt M	
Bypass					1/4 Bsp F + Plug	
Filtration parameter	50 mesh				300 µm	



F5 L - PLASTIC SUCTION STRAINER

P/N	Inlet	Outlet	Filtration standard		Weight				
			mesh	µm	gr	oz			
28.0320.00	1/2 Bsp F	1/2 Bspt M	46	300	198	6,98	20		✓
28.0320.15	1/2 Bsp F	1/2 Bspt M	100	150	195	6,88	20		
28.0320.50	1/2 Bsp F	1/2 Bspt M	300	50	164	5,78	20		
28.0320.20	1/2 Bsp F	1/2 Bsp F	46	300	164	5,78	20		✓
28.0320.65	1/2 Bsp F	1/2 Bsp F	100	150	164	5,78	20		✓
28.0320.85	1/2 Bsp F	1/2 Bsp F	300	50	166	5,85	20		
Rated Pressure	10 bar - 1 MPa				145 psi				
Rated Flow	(Dp 0.25 bar) 30 l/min				8 USGpm				
Rated Temperature	40 °C				105 °F				



F5 L B- PLASTIC STRAINER WITH BYPASS

P/N	Inlet	Outlet	Weight		20	
			gr	oz		
28.0370.00	1/2 Bsp F	1/2 Bsp M	165	5,8	20	✓
Rated Pressure	10 bar - 1 MPa				145 psi	
Rated Flow	(Dp 0.25 bar) 30 l/min				8 USGpm	
Rated Temperature	40 °C				105 °F	
Bypass					1/4 Bsp F	
Filtration parameter	46 mesh				300 µm	



FPL - PLASTIC STRAINER 3/4 BSP MF

P/N	Inlet	Outlet	Filtration standard		Col.	Weight		40	
			mesh	µm		gr	oz		
28.0130.00R	3/4 Bsp M	3/4 Bsp F	125	120	Gray	110	3,88	40	✓
28.0136.00R	3/4 Bsp M	3/4 Bsp F	233	60	White	108	3,81	40	✓
28.0137.22R	-	--	63	60	White	10	0,35	12	
Rated Pressure	10 bar - 1 MPa				145 psi				
Rated Flow	80 l/min				21 USGpm				
Rated Temperature	40 °C				140 °F				
Mat.					PP + SAN				
Seals material					NBR				



F 8 - PLASTIC SUCTION STRAINER

P/N	Inlet	Outlet	Filtration standard		Weight		20		
			mesh	µm	gr	oz			
28.0380.00	1/2 Bsp F	1/2 Bsp F	46	300	121,5	4,29	20		
28.0380.15	1/2 Bsp F	1/2 Bsp F	100	150	121,5	4,29	20	✓	
28.0380.50	1/2 Bsp F	1/2 Bsp F	300	50	122	4,3	20	✓	
28.0390.00	3/4 Bsp F	3/4 Bsp F	46	300	128	4,51	20	✓	
28.0390.15	3/4 Bsp F	3/4 Bsp F	100	150	126	4,44	20	✓	
Rated Pressure	10 bar - 1 MPa				145 psi				
Rated Flow	(Dp 0.25 bar) 30 l/min				8 USGpm				
Rated Temperature	40 °C				105 °F				



FA 1 ALUMINIUM STRAINER WITH BYPASS

P/N	Inlet	Outlet	Filtration standard		Weight		20		
			mesh	µm	gr	oz			
28.0010.00	1/2 Bsp F	1/2 Bsp M	38	400	217	7,65	20	✓	
28.0010.20	1/2 Bsp F	1/2 Bsp M	86	850	220	7,7	20	✓	
28.0010.50	1/2 Bsp F	1/2 Bsp M	38	400	217	7,65	20	✓	
Black coated									
28.0010.70	1/2 Bsp F	1/2 Bsp M	86	850	220	7,7	20	✓	
Black coated									
Rated Pressure	40 bar - 4 MPa				580 psi				
Rated Flow	25 l/min				6,5 USGpm				
Rated Temperature	90 °C				195 °F				
Bypass					1/4 Bsp F				
Material					Aluminium + Sst. net				





FY5 - PLASTIC STRAINER "Y"

P/N	Inlet	Outlet	Weight		5	
			gr	oz		
15.0004.12R	3/4 Bsp F	3/4 Bsp F	202	7,12	5	
15.0004.02R	1 Bsp F	1" Bsp F	180	6,35	5	
Rated Pressure	10 bar - 1 MPa				145 psi	
Rated Flow	80 l/min				21 USGpm	
Rated Temperature	40 °C				140 °F	
Filtration parameter	50 mesh				300 µm	
Material					PP + FG	



FYO - BRASS Y-STRAINER

P/N	Couplings	Length		Height		Weight		5	
		mm	in.	mm	in.	gr	oz		
28.0160.00R	3/8 Bsp F	56	2,2	39,5	1,55	139	4,9	5	
28.0162.00R	1/2 Bsp F	59	2,3	40	1,57	158	5,57	5	
28.0164.00R	3/4 Bsp F	70	2,75	48,5	1,91	247	8,71	5	
28.0162.50R	1/2 Npt F	59	2,3	40	1,57	154	5,43	5	
Rated Pressure	12 bar - 1,2 MPa				175 psi				
Rated Temperature	90 °C				195 °F				
Material					Brass + Sst net				
Filtration parameter	45 mesh				400 µm				



SUCTION NET STRAINER WITH HOSE BARB

P/N	Rated Flow		Hose barb		Weight		5	
	l/min	USGpm	mm	in.	gr	oz		
15.0000.02R	30	8	20	0,78	32	1,13	5	
15.0000.01R	55	14,5	25	1,0	36	1,27	5	
Rated Pressure	6 bar - 0,6 MPa				85 psi			
Rated Temperature	40 °C				104 °F			
Material					PPL +FG			
Filtration parameter	30 mesh				600 µm			



SUCTION NET STRAINER WITH THREADED BARB

P/N	Rated Flow		Outlet	Weight		5	
	l/min	USGpm		gr	oz		
15.0000.05R	55	14,5	1" Bsp F	40	1,41	5	
Rated Pressure	6 bar - 0,6 MPa				85 psi		
Rated Temperature	40 °C				104 °F		
Material					PPL +FG		
Filtration parameter	30 mesh				600 µm		



SUCTION STRAINER WITH HOSE BARB AND CHECK VALVE

P/N	Hose barb		Type	Weight		10	
	mm	in.		gr	oz		
28.0060.00R	19	0,75	Check valve	40	1,41	10	
28.0062.00R	19	0,75	-	24	0,85	10	
Without check valve							
Rated Pressure	0,6 bar - 0,06 MPa				9 psi		
Rated Temperature	40 °C				104 °F		
Material					PPL		



SP9 - CAR WASH BRUSH

P/N	Inlet	Bristle Length		Weight			
		mm	in	gr	oz		
29.0545.00	1/4 Bsp F	97	3,8	782	27,58	5	✓
29.0540.00	1/2 Npt F	97	3,8	782	27,58	5	✓
29.0542.21R	-	97	3,8	465	16,4	3	

Spare part - Holder w/ black black synthetic bristles

Rated Pressure 5 bar - 0,5 MPa 72,5 psi
 Rated Temperature 60 °C 140 °F
 Bristle Material Soft Synthetic



SR8 ROTATING BRUSH

P/N	Hair material	Nozzle	Weight			
			mm	gr		
29.0500.00R	White Nylon	3	916	32,31	1	✓

Rated Pressure 30 bar - 3 MPa 435 psi
 Rated Flow 30 l/min 8 USGpm
 Rated Temperature 60 °C 140 °F
 Inlet 1/4 Bsp M





VB200-180 ZERO-ZEROED OUTLET PRESSURE, IN BYPASS **NEW**

P/N	Rated pr.		Permiss.press.		Max. flow rate		Weight			
	bar - MPa	psi	bar - MPa	psi	l/min	USGpm	gr	oz		
60.2700.00	180 - 18	2610	200 - 20	2900	200	53	4354	153	1	
Min. flow rate		120 l/min		32 USGpm						
Max. working temperature		90 °C		195 °F						
Couplings				1" Bsp F						
Material				Brass						

Patent No.: I-1387704/-/US-2009-0205716-A1-/EP 2 093 643 A2-/ZL200810131662.7



VB 200/150-VB200/70

P/N	Rated pr.		Permiss.press.		Couplings	Weight			
	bar - MPa	psi	bar - MPa	psi		gr	oz		
60.5000.15	150 - 15	2200	170 - 17	2450	1" Bsp F	2025	71,7	1	✓
60.5000.001	150 - 15	2200	170 - 17	2450	1" Npt F	2046	72,16	6	
60.5000.00	150 - 15	2200	170 - 17	2450	1" Npt F	2046	72,16	1	✓
60.5020.15	150 - 15	2200	170 - 17	2450	1" Bsp F	2060	73,5	1	✓
With hand wheel									
60.5020.00	150 - 15	2200	170 - 17	2450	1" Npt F	2114	74,56	1	✓
With handwheel									
60.5000.10	150 - 15	2200	170 - 17	2450	1" Bsp F	2025	71,7	1	✓
Viton O-Rings									
60.5025.15	70 - 7	1000	80 - 8	1150	1" Bsp F	2085	73,54	1	✓
60.5025.00	70 - 7	1000	80 - 8	1150	1" Npt F	2017	71,14	1	
Rated Flow		200 l/min		53 USGpm					
Rated Temperature		90 °C		195 °F					



VB 140/160

P/N	Rated pr.		Permiss.press.		Couplings	Weight			
	bar - MPa	psi	bar - MPa	psi		gr	oz		
60.4800.00	160 - 16	2300	180 - 18	2600	3/4 Bsp F	1802	63,56	1	✓
60.4800.50	160 - 16	2300	180 - 18	2600	3/4 Npt F	1802	63,56	1	
Rated Flow		140 l/min		37 USGpm					
Rated Temperature		90 °C		195 °F					



VB 130 UNLOADER VALVE

P/N	Rated pr.		Permiss.press.		Couplings	Bypass	Weight		✓
	bar - MPa	psi	bar - MPa	psi			gr	oz	
60.0300.50	70 - 7	1015	80 - 8	1150	3/8 Bsp MM	3/8 Bsp F	382	13,47	40 ✓
60.0300.55	70 - 7	1015	80 - 8	1150	3/8 Npt MM	3/8 Npt F	386	13,61	40
60.0300.00	160 - 16	2300	180 - 18	2600	3/8 Bsp MM	3/8 Bsp F	388	13,68	40 ✓
60.0300.05	160 - 16	2300	180 - 18	2600	3/8 Npt MM	3/8 Npt F	390	13,9	40 ✓

Rated Flow 25 l/min 6,5 USGpm
 Rated Temperature 90 °C 195 °F
 On request - plastic knob 60.0315.84



VB 130 - WITH INJECTOR

P/N	Injector	Nozzle	Outlet	Weight		✓
				gr	oz	
60.0320.18	Adjustable	1,8 mm	3/8 Bsp M	520	18,34	30
60.0321.21	Fixed	2,1 mm	3/8 Bsp M	499	17,6	30

Rated Pressure 160 bar - 16 MPa 2300 psi
 Permissible Pressure 180 bar - 18 MPa 2600 psi
 Rated Flow 25 l/min 6,5 USGpm
 Rated Temperature 90 °C 195 °F



VB 135 - BANJO CONNECTION - HOLLOW SCREW FITTING

P/N	Dist.betw.ports	Couplings	Pump type	Weight		✓
				gr	oz	
60.0380.25	X:0 Y:62	1/4 × 3/8 Bsp	IP serie 51	622	21,94	5 ✓
60.0800.00	X:5 Y:53	3/8 × 1/2 Bsp	AR XT-HPE	652	23	24 ✓
60.0812.00	X:5 Y:57	3/8 × 1/2 Bsp	AR XM	662	23,35	20
60.0820.00	X:0 Y:56	3/8 × 3/8 Bsp	Speck NP10	613	21,62	25
60.0825.00	X:0 Y:63	3/8 × 3/8 Bsp	Udor SF	620	21,9	20

Rated Pressure 160 bar - 16 MPa 2300 psi
 Permissible Pressure 180 bar - 18 MPa 2600 psi
 Rated Flow 25 l/min 6,5 USGpm
 Rated Temperature 90 °C 195 °F



VB130-VB3-VB7-VB75 PLASTIC KNOB



P/N	Inlet	Col.	Weight		✓
			gr	oz	
60.0315.84R	Hex.22	Black	14	0,5	10 ✓

Plastic knob





VB20-160-VB30-220 ZERO-ZEROED OUTLET PRESSURE, IN BYPASS

P/N	Permiss.press.		Max. flow rate		Weight		 
	bar - MPa	psi	l/min	USGpm	gr	oz	
60.2500.00	160 - 16	2300	20	5,3	662,3	23,4	15
60.2520.00	220 - 22	3200	30	8	662,3	23,4	15

Min. flow rate 8 l/min 2,1 USGpm
 Rated Temperature 60 °C 140 °F
 Couplings 3/8 Bsp F
 Material Brass

Patent No.: I-1387704-I-US-2009-0205716-A1-I-EP 2 093 643 A2-I-ZL200810131662.7



VB20-160 ZERO WITH MICRO-SWITCH-ZEROED OUTLET PRESSURE, IN BYPASS 



P/N	Inlet	Outlet	Bypass	Weight		 
				gr	oz	
60.2550.00	3/8 Bsp F	3/8 Bsp F	3/8 Bsp F	772,8	27,2	12

Permissible Pressure 160 bar - 16 MPa 2300 psi
 Min. flow rate 8 l/min 2,1 USGpm
 Max. flow rate 20 l/min 5,3 USGpm
 Rated Temperature 60 °C 140 °F
 Max. Curr. Strength 6 (2) A
 Max. Voltage 250 V
 Material Brass

Patent No.: I-1387704-I-US-2009-0205716-A1-I-EP 2 093 643 A2-I-ZL200810131662.7



PULSAR RV- VALVE 3/8 BSP F - VITON O-RING



P/N	Inlet	Outlet	Bypass	Type	Weight		 
					gr	oz	
60.0122.06	2× 3/8 Npt F	3/8 Npt F	2× 3/8 Npt F	A	708	24,97	25
60.0125.06	2× 3/8 Npt F	3/8 Npt F	2× 3/8 Npt F	B	752	26,52	15

With knob

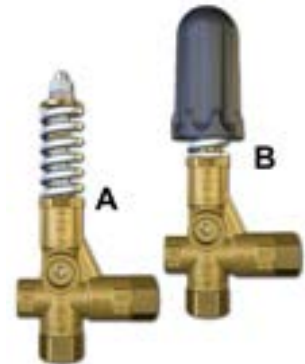
Rated Pressure 160 bar - 16 MPa 2300 psi
 Permissible Pressure 180 bar - 18 MPa 2600 psi
 Rated Flow 40 l/min 10,5 USGpm
 Rated Temperature 90 °C 195 °F
 Seals material FKM (Viton)°





VB 450 - 200 - UNLOADER VALVE

P/N	Inlet	Outlet	Bypass	Weight		 
				gr	oz	
60.4020.00	1" 1/4 Bsp F	1" 1/4 Bsp F	1" 1/2 Bsp F	6138	216,49	1 

Rated Pressure 200 bar - 20 MPa 2900 psi
 Permissible Pressure 220 bar - 22 MPa 3200 psi
 Rated Flow 450 l/min 120 USGpm
 Rated Temperature 90 °C 195 °F





VB 3- UNLOADER VALVE



P/N	Inlet	Outlet	Bypass	Weight		 	
				gr	oz		
60.1900.00	3/8 Bspt M	3/8 Bsp M	3/8 Bsp F	390	13,75	40	✓
60.1900.05	3/8 Npt M	3/8 Npt M	3/8 Npt F	393	13,86	40	✓
Rated Pressure	220 bar - 22 MPa			3200 psi			
Permissible Pressure	250 bar - 25 MPa			3650 psi			
Rated Flow	25 l/min			6,5 USGpm			
Rated Temperature	90 °C			195 °F			

On request - plastic knob 60.0315.84



VB 35 - BANJO CONNECTION - HOLLOW SCREW FITTING

P/N	Dist.betw.ports	Couplings	Pump type	Weight		 	
				gr	oz		
60.0845.00	X:4,5 Y:64	3/8 × 1/2 Bsp	AR RK	696	24,55	24	
60.0850.00	X:19 Y:62-73	3/8 × 1/2 Bsp	IP 44-47-50-60-63 SpeckNP16 Udor M	708	24,97	24	✓
60.0880.00	X:5 Y:53,5	3/8 × 1/2 Bsp	AR XT - HPE - Bertolini TW - KWE	681	24,02	24	✓
60.0860.00	X:19,5 Y:57	3/8 × 1/2 Bsp	IP.E1- E2 - E3	695	24,51	24	✓
Rated Pressure	220 bar - 22 MPa			3200 psi			
Permissible Pressure	250 bar - 25 MPa			3650 psi			
Rated Flow	25 l/min			6,5 USGpm			
Rated Temperature	90 °C			195 °F			
Outlet				3/8 Bsp M			

VB 35 - BANJO CONNECTION- HOLLOW SCREW FITTING- ADJUST.INJECTOR

P/N	Dist.betw.ports	Couplings	Pump type	Nozzle	Weight			 	
					mm	gr	oz		
60.0855.21	X:19 Y:62-73	3/8 × 1/2 Bsp	IP 50-44-47-60-63	2,1	827	29,17	20		
60.0870.18	X:16 Y:57	3/8 × 3/8 Bsp	Udor	1,8	762	26,88	20		
60.0870.21	X:16 Y:57	3/8 × 3/8 Bsp	Udor	2,1	763	26,91	20		
60.0873.18	X:19,5 Y:57	3/8 × 1/2 Bsp	Udor PN	1,8	816	28,78	20		
Rated Pressure	220 bar - 22 MPa			3200 psi					
Permissible Pressure	250 bar - 25 MPa			3650 psi					
Rated Flow	25 l/min			6,5 USGpm					
Rated Temperature	90 °C			195 °F					
Outlet				3/8 Bsp M					
Injector				Adjustable					

VB 5 - UNLOADER VALVE

P/N	Inlet	Outlet	Bypass	Weight		 	
				gr	oz		
60.1300.10	3/8 Bsp M	3/8 Bsp F	3/8 Bsp F	609	21,48	30	✓
Rated Pressure	220 bar - 22 MPa			3200 psi			
Permissible Pressure	250 bar - 25 MPa			3650 psi			
Rated Flow	30 l/min			8 USGpm			
Rated Temperature	90 °C			195 °F			





VB 56 - BANJO CONNECTION - HOLLOW SCREW FITTING -OUT. 3/8 BSP F F

P/N	Dist.betw.ports	Couplings	Pump type	Weight			
				gr	oz		
60.1350.10	X:19 Y:62-73	3/8 ×1/2 Bsp	IP 44-47-50-60-63 SpeckNP16	952	33,62	20	✓
60.1372.10	X:26 Y:66-76	3/8 ×1/2 Bsp	Leuco MT-LT	952	33,62	10	✓
Rated Pressure	220 bar - 22 MPa		3200 psi				
Permissible Pressure	250 bar - 25 MPa		3650 psi				
Rated Flow	30 l/min		8 USGpm				
Rated Temperature	90 °C		195 °F				
Outlet			3/8 Bsp F				



VB 56 - BANJO CONNECTION - HOLLOW SCREW FITTING -OUT. 3/8 BSP M

P/N	Dist.betw.ports	Couplings	Pump type	Weight			
				gr	oz		
60.1356.10	X:5 Y:53,5	3/8 ×1/2 Bsp	Bertol.TM-WM-TW-KWE	900	31,74	20	
60.1362.10	X:4,5 Y:53-57	3/8 × 3/8 Bsp	Bertol.WJ	900	31,74	20	
60.1350.32	X:19 Y:62-73	3/8 ×1/2 Bsp	IP 50-44-47-60-63	930	32,8	20	
Rated Pressure	220 bar - 22 MPa		3200 psi				
Permissible Pressure	250 bar - 25 MPa		3650 psi				
Rated Flow	30 l/min		8 USGpm				
Rated Temperature	90 °C		195 °F				
Outlet			3/8 Bsp M				



VB 7 - UNLOADER VALVE

P/N	Inlet	Outlet	Bypass	Weight			
				gr	oz		
60.0700.00	3/8 Bsp M	3/8 Bsp F	3/8 Bsp F	560	19,75	40	✓
60.0700.40	3/8 Bsp M	3/8 Bsp M	3/8 Bsp F	566	19,96	25	✓
Rated Pressure	220 bar - 22 MPa		3200 psi				
Permissible Pressure	250 bar - 25 MPa		3650 psi				
Rated Flow	30 l/min		8 USGpm				
Rated Temperature	90 °C		195 °F				

On request - plastic knob 60.0315.84



VB 7 WITH INJECTOR

P/N	Injector	Nozzle mm	Outlet	Weight		25	30
				gr	oz		
60.0750.21	Adjustable	2,1	3/8 Bsp M	688	24,27	25	
60.0745.21	Fixed	2,1	3/8 Bsp M	670	23,6	30	
60.0746.21	Fixed	2,1	A M22	688	24,26	30	
Rated Pressure	220 bar - 22 MPa			3200 psi			
Permissible Pressure	250 bar - 25 MPa			3650 psi			
Rated Flow	30 l/min			USGpm			
Rated Temperature	90 °C			195 °F			
Inlet				3/8 Bsp M			



VB 75 - BANJO CONNECTION - HOLLOW SCREW FITTING

P/N	Dist.betw.ports	Couplings	Pump type	Weight		20	✓
				gr	oz		
60.0753.00	X:0 Y:63	3/8 × 1/2 Bsp	Comet LW-ZW	880	31,04	20	
60.0765.00	X:5 Y:56	3/8 × 1/2 Bsp	AR- XM	856	30,19	20	✓
60.0770.00	X:4,5 Y:64	3/8 × 1/2 Bsp	AR-RK Comet FW	868	30,62	20	✓
60.0930.00	X:18 Y:62-73	3/8 × 1/2 Bsp	IP 44-47-50-60-63 SpeckNP16	900	31,7	20	✓
60.0950.00	X:0 Y:62	1/4 × 3/8 Bsp	IP serie 51	837	29,52	20	
60.0768.10	X:4,5 Y:64	3/8 × 1/2 Bsp	AR-RK Comet FW	869	30,65	20	
O-rings Viton							
Rated Pressure	220 bar - 22 MPa			3200 psi			
Permissible Pressure	250 bar - 25 MPa			3650 psi			
Rated Flow	30 l/min			8 USGpm			
Rated Temperature	90 °C			195 °F			



On request - plastic knob 60.0315.84

VB 8

P/N	Inlet	Outlet	Bypass	Weight		20	✓
				gr	oz		
60.1240.00	3/8 Bsp M	3/8 Bsp F	3/8 Bsp F	726	25,61	20	✓
With black plastic knob and panel fitting nut.							
Rated Pressure	220 bar - 22 MPa			3200 psi			
Permissible Pressure	250 bar - 25 MPa			3650 psi			
Rated Flow	30 l/min			8 USGpm			
Rated Temperature	90 °C			195 °F			
Panel fitting	30 mm			1,18 in			





VB 8 WITH MICRO-SWITCH-PR5

P/N	Inlet	Outlet	Bypass	Weight		12	✓
				gr	oz		
60.1280.00	3/8 Bsp M	3/8 Bsp F	3/8 Bsp F	758	26,74	12	✓
60.1290.00	3/8 Bsp M	3/8 Bsp F	3/8 Bsp F	815	28,7	12	✓
With black plastic knob and panel fitting nut.							
Rated Pressure	220 bar - 22 MPa			3200 psi			
Permissible Pressure	250 bar - 25 MPa			3650 psi			
Rated Flow	30 l/min			8 USGpm			
Rated Temperature	90 °C			195 °F			
Max. Curr. Strength				6 (2) A			
Max. Voltage				250 V			







VB 8 WITH MICRO-SWITCH-PR16

P/N	Inlet	Outlet	Bypass	Weight			
				gr	oz		
60.1296.00	3/8 Bsp M	3/8 Bsp F	3/8 Bsp F	872	30,76	12	
With black plastic knob and panel fitting nut.							
Rated Pressure	220 bar - 22 MPa			3200 psi			
Permissible Pressure	250 bar - 25 MPa			3650 psi			
Rated Flow	30 l/min			8 USGpm			
Rated Temperature	90 °C			195 °F			
Max. Curr. Strength				16 (6) A			
Max. Voltage				250 V			





VB 9

P/N	Inlet	Outlet	Bypass	Weight			
				gr	oz		
60.2200.00	3/8 Bsp F	3/8 Bsp F	3/8 Bsp F	646	22,78	25	
Rated Pressure	220 bar - 22 MPa			3200 psi			
Permissible Pressure	250 bar - 25 MPa			3650 psi			
Rated Flow	30 l/min			8 USGpm			
Rated Temperature	90 °C			195 °F			







VB 9 WITH KNOB AND PANEL FITTING

P/N	Inlet	Outlet	Bypass	Weight			
				gr	oz		
60.2250.00	3/8 Bsp F	3/8 Bsp F	3/8 Bsp F	770	27,2	25	
Rated Pressure	220 bar - 22 MPa			3200 psi			
Permissible Pressure	250 bar - 25 MPa			3650 psi			
Rated Flow	30 l/min			8 USGpm			
Rated Temperature	90 °C			195 °F			



VB 9 WITH KNOB AND MICRO-SWITCH

P/N	Inlet	Outlet	Bypass	Gauge bolt	Weight			
					gr	oz		
60.2350.00	3/8 Bsp F	3/8 Bsp F	3/8 Bsp F	1x 1/4 Bsp F	1022	36,33	12	
60.2365.00	3/8 Bsp F	3/8 Bsp F	3/8 Bsp F	2 x 1/4 Bsp F	1036	36,54	12	
Rated Pressure	220 bar - 22 MPa			3200 psi				
Permissible Pressure	250 bar - 25 MPa			3650 psi				
Rated Flow	30 l/min			8 USGpm				
Rated Temperature	90 °C			195 °F				
Max. Curr. Strength				6 (2) A				
Max. Voltage				250 V				
Cable length	1000 mm			39,4 in				



VB 10 WITH KNOB

P/N	Inlet	Outlet	Bypass	Weight		12	✓
				gr	oz		
60.1100.00	3/8 Bsp F	3/8 Bsp F	3/8 Bsp F	1100	38,8	12	✓
60.1100.50	3/8 Npt F	3/8 Npt F	3/8 Npt F	1100	38,8	12	✓
60.1150.00	3/8 Bsp F	3/8 Bsp F	3/8 Bsp F	1200	42,3	12	✓



Rated Pressure	220 bar - 22 MPa	3200 psi
Permissible Pressure	250 bar - 25 MPa	3650 psi
Residual pressure at close	62 bar - 6,2 MPa	900 psi
Min.bypass re-start	34 bar - 3,4 MPa	500 psi
Rated Flow	30 l/min	8 USGpm
Rated Temperature	90 °C	195 °F

Patent No.: I 1262632- Usa 5,372,157- J 2749512

VB 80A/150 - ATEX--AI 303-



P/N	Rated pr.		Permiss.press.		Couplings	Seals material	Weight		1	✓
	bar - MPa	psi	bar - MPa	psi			gr	oz		
60.0448.15	150 - 15	2200	170 - 17	2450	1/2 Bsp F	Ni 85	1226	43,24	1	✓
60.0448.33	150 - 15	2200	170 - 17	2450	1/2 Bsp F	Epdm+FFKM (Kalrez)°	1226	43,24	1	✓





Rated Flow	80 l/min	21 USGpm
Rated Temperature	70 °C	158 °F
Material	Stainless steel 303	
Certification	ATEX	





PULSAR ZERO WITH KNOB AND MICRO-SWITCH -ZEROED OUTLET PRESSURE, IN BYPASS 

P/N	Inlet	Outlet	Bypass	Weight			
				gr	oz		
60.2450.00	3/8 Bsp F	3/8 Bsp F	2× 3/8Bsp F	1228	43,31	12	
60.2450.50	3/8 Npt F	3/8 Npt F	2× 3/8 Npt F	1250	44,09	12	

Permissible Pressure	280 bar - 28 MPa	4050 psi
Max. flow rate	40 l/min	10,5 USGpm
Min. flow rate	9 l/min	2,4 USGpm
Rated Temperature	60 °C	140 °F
Max. Temper.	90 °C	195 °F
Max. Curr. Strength		6 (2) A
Max. Voltage		250 V

Patent No.: I-1387704/-/US-2009-0205716-A1/-/EP 2 093 643 A2/-/ZL200810131662.7



VB80/280 ZERO - VALVE WITH ZEROED OUTLET PRESSURE, IN BYPASS



P/N	Inlet	Outlet	Bypass	Weight			
				gr	oz		
60.2800.00	1/2 Bsp F	1/2 Bsp F	1/2 Bsp F	1710	60,31	4	

Permissible Pressure	280 bar - 28 MPa	4050 psi
Min. flow rate	20 l/min	5,3 USGpm
Max. flow rate	80 l/min	21 USGpm
Rated Temperature	60 °C	140 °F
Max. Temper.	90 °C	195 °F
Material		Brass

Patent No.: I-1387704/-/US-2009-0205716-A1/-/EP 2 093 643 A2/-/ZL200810131662.7



VB80/280 ZERO WITH KNOB AND MICRO-SWITCH - VALVE WITH ZEROED OUTLET PRESSURE, IN BYPASS 

P/N	Inlet	Outlet	Bypass	Weight			
				gr	oz		
60.2850.00	1/2 Bsp F	1/2 Bsp F	1/2 Bsp F	1825,2	64,4	1	

Permissible Pressure	280 bar - 28 MPa	4050 psi
Max. flow rate	80 l/min	21 USGpm
Min. flow rate	20 l/min	5,3 USGpm
Rated Temperature	60 °C	140 °F
Max. Temper.	90 °C	195 °F
Max. Curr. Strength		6 (2) A
Max. Voltage		250 V

Patent No.: I-1387704/-/US-2009-0205716-A1/-/EP 2 093 643 A2/-/ZL200810131662.7





PULSAR RV - UNLOADER VALVE

P/N	Rated pr.		Permiss.press.		Type	Outlet	Weight		✓	
	bar - MPa	psi	bar - MPa	psi			gr	oz		
60.0000.00	160 - 16	2300	180 - 18	2600	B	3/8 Bsp F	711	25,08	20	✓
60.0000.05	160 - 16	2300	180 - 18	2600	B	3/8 Npt F	712	25,11	25	✓
60.0000.60	280 - 28	4050	310 - 31	4500	A	3/8 Bsp F	744	26,24	20	✓
60.0000.63	280 - 28	4050	310 - 31	4500	A	3/8 Bsp F	744	26,24	25	✓
Shutter pin, Sst.										
60.0000.65	280 - 28	4050	310 - 31	4500	A	3/8 Npt F	744	26,24	25	✓
Rated Flow			40 l/min		10 USGpm					
Rated Temperature			90 °C		195 °F					
Material					Brass					



Valves with 2 ports each for inlet and bypass : 3/8 Bsp F and/or 3/8Npt F

PULSAR RV - BYPASS VALVE WITH KNOB

P/N	Rated pr.		Permiss.press.		Type	Outlet	Weight		✓	
	bar - MPa	psi	bar - MPa	psi			gr	oz		
60.0007.00	160 - 16	2300	180 - 18	2600	B	3/8 Bsp F	780	27,51	15	✓
60.0007.05	160 - 16	2300	180 - 18	2600	B	3/8 Npt F	780	27,51	15	✓
60.0007.60	280 - 28	4050	310 - 31	4500	A	3/8 Bsp F	780	27,51	15	✓
60.0007.63	280 - 28	4050	310 - 31	4500	A	3/8 Bsp M	777	27,4	15	✓
60.0007.65	280 - 28	4050	310 - 31	4500	A	3/8 Npt F	780	27,51	15	✓
Rated Flow			40 l/min		10 USGpm					
Rated Temperature			90 °C		195 °F					



Valves with 2 ports each for inlet and bypass : 3/8 Bsp F and/or 3/8Npt F

PULSAR RV / HT UNLOADER VALVE -NICKEL-PLATED BRASS **NEW**

P/N	Type	Rated pr.		Permiss.press.		Max. working.Temp		Rated Temper.		Weight		✓	
		bar - MPa	psi	bar - MPa	psi	°C	°F	°C	°F	gr	oz		
60.0000.62	A	280 - 28	4050	310 - 31	4500	60	140	90	195	744	26,24	25	✓
60.0040.00	B	280 - 28	4050	310 - 31	4500	85	185	90	195	744	26,24	25	✓
Rated Flow			40 l/min		10 USGpm								
Outlet					3/8 Bsp F								
Material					Nickel plated brass								



Valves with 2 ports each for inlet and bypass : 3/8 Bsp F and/or 3/8Npt F



PULSAR RV + 1/4 BSP F GAUGE PORT

P/N	Rated pr.		Permiss.press.		Weight			
	bar - MPa	psi	bar - MPa	psi	gr	oz		
60.0045.60	280 - 28	4050	310 - 31	4500	764	26,95	25	✓
Rated Flow	40 l/min		10 USGpm					
Rated Temperature	90 °C		195 °F					
Inlet			2x 3/8 Bsp F					
Outlet			3/8 Bsp F					
Bypass			2x 3/8Bsp F					
Gauge port			1x 1/4 Bsp F					

With 1/4 Bsp F gauge port



PULSAR RV WITH KNOB/ GAUGE PORT

P/N	Rated pr.		Permiss.press.		Outlet	Weight			
	bar - MPa	psi	bar - MPa	psi		gr	oz		
60.0016.00	160 - 16	2300	180 - 18	2600	3/8 Bsp F	781	27,55	15	✓
60.0016.60	280 - 28	4050	310 - 31	4500	3/8 Bsp F	803	28,32	15	✓
Gauge port									
Rated Flow	40 l/min		10,5 USGpm						
Rated Temperature	90 °C		195 °F						
Gauge port			1x 1/4 Bsp F						

Valves with 2 ports each for inlet and bypass : 3/8 Bsp F - Suitable for recycled water and strong detergents.



PULSAR RV WITH MICRO-SWITCH/ KNOB

P/N	Rated pr.		Permiss.press.		Couplings	Gauge bolt	Type	Weight			
	bar - MPa	psi	bar - MPa	psi				gr	oz		
60.0006.00	160 - 16	2300	180 - 18	2600	3/8 Bsp FF	-	A	916	32,31	15	
60.0006.05	160 - 16	2300	180 - 18	2600	3/8 Npt F	-	A	890	31,39	15	
60.0006.60	280 - 28	4050	310 - 31	4500	3/8 Bsp FF	-	B	919	32,41	15	✓
60.0006.65	280 - 28	4050	310 - 31	4500	3/8 Npt F	-	B	920	32,45	10	✓
60.0013.60	280 - 28	4050	310 - 31	4500	3/8 Bsp FF	1x 1/4 Bsp F	C	916	32,31	10	✓
Rated Flow	40 l/min		10,5 USGpm								
Rated Temperature	90 °C		195 °F								
Max. Curr. Strength			16 (6) A								
Max. Voltage			250 V								

Suitable for recycled water and strong detergents.





PULSAR RV WITH MICRO-SWITCH

P/N	Rated pr.		Permiss.press.		Couplings	Weight			
	bar - MPa	psi	bar - MPa	psi		gr	oz		
60.0023.60	280 - 28	4050	310 - 31	4500	3/8 Bsp FF	880	31,04	10	✓
60.0023.65	280 - 28	4050	310 - 31	4500	3/8 Npt F	884	31,18	10	
Rated Flow	40 l/min		10,5 USGpm						
Rated Temperature	90 °C		195 °F						
Max. Curr. Strength			16 (6) A						
Max. Voltage			250 V						





PULSAR RV - UNLOA.VAL. WITH EASY STARTER AND KNOB

P/N	Couplings	Weight		15	 
		gr	oz		
60.0008.76	3/8 Bsp F	750	26,45	15	
Installation in vertical position.					
60.0007.86	3/8 Npt F	741	26,14	15	✓
Installation in vertical position.					
Rated Pressure	280 bar - 28 MPa			4050 psi	
Permissible Pressure	310 bar - 31 MPa			4500 psi	
Rated Flow	40 l/min			10,5 USGpm	
Rated Temperature	90 °C			195 °F	





VB 280 WITH KNOB

P/N	Inlet	Outlet	Bypass	Weight		5	 
				gr	oz		
60.1600.00	3/8 Bsp M	3/8 Bsp F	1/2 Bsp F	886	31,25	5	
Rated Pressure	280 bar - 28 MPa			4050 psi			
Permissible Pressure	310 bar - 31 MPa			4500 psi			
Rated Flow	40 l/min			10,5 USGpm			
Rated Temperature	90 °C			195 °F			



VB 285 WITH KNOB - BANJO CONNECTION - HOLLOW SCREW FITTING

P/N	Dist.betw.ports	Couplings	Pump type	Weight		10	 
				gr	oz		
60.0960.00	X:18 Y:63	3/8 x1/2 Bsp	IP serie 44- Udor MK	1248	44,02	10	✓
Rated Pressure	280 bar - 28 MPa			4050 psi			
Permissible Pressure	310 bar - 31 MPa			4500 psi			
Rated Flow	30 l/min			8 USGpm			
Rated Temperature	90 °C			195 °F			
Outlet				3/8 Bsp F			





VB 85/180 - VB 85/310 WITH GAUGE PORT

P/N	Rated pr.		Permiss.press.		Couplings	Type	Weight		4	✓
	bar - MPa	psi	bar - MPa	psi			gr	oz		
60.0423.04	160 - 16	2300	180 - 18	2600	1/2 Bsp F	B	1138	40,14	4	✓
60.0423.64	280 - 28	4050	310 - 31	4500	1/2 Bsp F	A	1170	41,27	4	✓

Rated Flow 80 l/min 21 USGpm
 Rated Temperature 90 °C 195 °F
 Gauge port 1x 1/4 Bsp F
 CE Mark YES

With 1/4 Bsp F gauge port

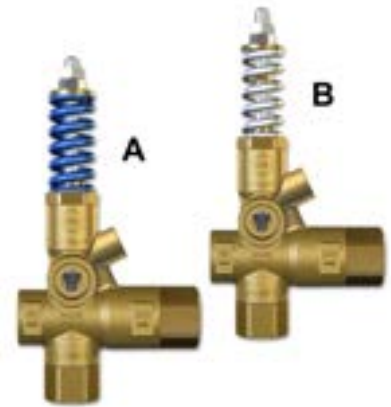

VB 85 R/180 - VB 85 R/310 --UNLOADER VALVE

P/N	Rated pr.		Permiss.press.		Couplings	Type	Weight		4	✓
	bar - MPa	psi	bar - MPa	psi			gr	oz		
60.0423.00	160 - 16	2300	180 - 18	2600	1/2 Bsp F	B	1122	39,57	4	✓
60.0423.05	160 - 16	2300	180 - 18	2600	1/2 Npt F	B	1122	39,57	4	✓
60.0423.60	280 - 28	4050	310 - 31	4500	1/2 Bsp F	A	1152	40,63	4	✓
60.0423.65	280 - 28	4050	310 - 31	4500	1/2 Npt F	A	1152	40,63	4	✓

Rated Flow 80 l/min 21 USGpm
 Rated Temperature 90 °C 195 °F

Suitable for recycled water and strong detergents.

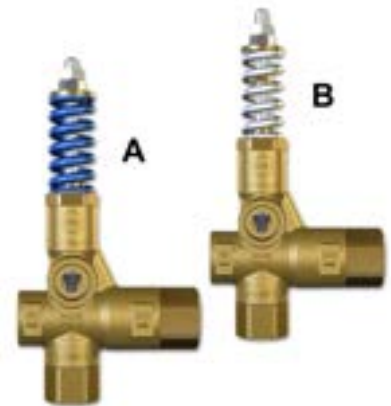

VB 85 RV/180 - VB 85 RV/310-UNLOADER VALV. WITH KNOB

P/N	Type	Rated pr.		Permiss.press.		Couplings	Weight		4	✓
		bar - MPa	psi	bar - MPa	psi		gr	oz		
60.0427.00	B	160 - 16	2300	180 - 18	2600	1/2 Bsp F	1164	41	4	✓
60.0427.05	B	160 - 16	2300	180 - 18	2600	1/2 Npt F	1142	40,28	4	✓
60.0427.60	A	280 - 28	4050	310 - 31	4500	1/2 Bsp F	1190	41,97	4	✓
60.0427.65	A	280 - 28	4050	310 - 31	4500	1/2 Npt F	1169	41,23	4	✓

Rated Flow 80 l/min 21 USGpm
 Rated Temperature 90 °C 195 °F





VB85 RV/310 UNLOA.VAL. WITH MICRO-SWITCH

P/N	Rated pr.		Permiss.press.		Couplings	Type	Weight			
	bar - MPa	psi	bar - MPa	psi			gr	oz		
60.0484.65	280 - 28	4050	310 - 31	4500	1/2 Npt F	A	1154	40,7	12	
Rated Flow	80 l/min		21 USGpm							
Rated Temperature	90 °C		195 °F							
Max. Curr. Strength			16 (6) A							
Max. Voltage			250 V							



VB33 - UNLOADER VALVE

P/N	Rated pr.		Permiss.press.		Couplings	Weight				
	bar - MPa	psi	bar - MPa	psi		gr	oz			
60.1850.00	280 - 28	4050	310 - 31	4500	1/2 Bsp F	1058	37,32	4	✓	
60.1850.50	280 - 28	4050	310 - 31	4500	1/2 Npt F	1088	38,37	4	✓	
60.1850.00	280 - 28	4050	310 - 31	4500	1/2 Bsp F	1058	37,32	4	✓	
Rated Flow	80 l/min		21 USGpm							
Rated Temperature	90 °C		195 °F							
Material			Brass							





VB33- HT 28MPa - UNLOADER VALVE FOR HOT TEMPERATURE WATER

P/N	Rated pr.		Permiss.press.		Couplings	Type	Weight			
	bar - MPa	psi	bar - MPa	psi			gr	oz		
60.1820.00	280 - 28	4050	310 - 31	4500	1/2 Bsp F	A	1085	38,27	2	✓
60.1820.50	280 - 28	4050	310 - 31	4500	1/2 Npt F	A	1085	38,27	2	✓
Rated Flow	80 l/min		21 USGpm							
Rated Temperature	90 °C		195 °F							
Max. Temper.	85 °C		185 °F							
Material			Brass							







VB 200/280 - UNLOADER VALVE

P/N	Couplings	Weight		 
		gr	oz	
60.4300.00	1" Bsp F	3482	122,81	1 
Rated Pressure	280 bar - 28 MPa			4050 psi
Permissible Pressure	310 bar - 31 MPa			4500 psi
Rated Flow	200 l/min			53 USGpm
Rated Temperature	90 °C			195 °F
Material	Brass			





VB 450 - 300 - UNLOADER VALVE

P/N	Inlet	Outlet	Bypass	Weight		 
				gr	oz	
60.4030.00	1" 1/4 Bsp F	1" 1/4 Bsp F	1" 1/2 Bsp F	6141	216,6	1 
Rated Pressure	300 bar - 30 MPa					4350 psi
Permissible Pressure	330 bar - 33 MPa					4800 psi
Rated Flow	450 l/min					120 USGpm
Rated Temperature	90 °C					195 °F
Material					Brass	



VB 80A/280 - AISI 303 ATEX  

P/N	Rated pr.		Permiss.press.		Couplings	Weight		 
	bar - MPa	psi	bar - MPa	psi		gr	oz	
60.0448.28	280 - 28	4050	310 - 31	4500	1/2 Bsp F	1275	45,1	1
Rated Flow	80 l/min						21 USGpm	
Rated Temperature	70 °C						158 °F	
Material					Stainless steel 303			
Certification					ATEX			







VB 80 /150-280 - AISI 316 -VITON O-RINGS

P/N	Rated pr.		Permiss.press.		Couplings	Type	Weight			
	bar - MPa	psi	bar - MPa	psi			gr	oz		
60.0450.00	150 - 15	2200	170 - 17	2450	1/2 Bsp F	B	1178	41,55	1	✓
60.0450.05	150 - 15	2200	170 - 17	2450	1/2 Npt F	B	1190	41,97	1	
60.0450.60	280 - 28	4050	310 - 31	4500	1/2 Bsp F	A	1214	42,82	1	✓

Rated Flow 80 l/min 21 USGpm
 Rated Temperature 90 °C 195 °F
 Material Stainless steel Ai316
 Seals material FKM (Viton)°



VB 80A/150- 280 ATEX -AISII 316 -VITON O-RINGS  



P/N	Rated pr.		Permiss.press.		Couplings	Type	Weight			
	bar - MPa	psi	bar - MPa	psi			gr	oz		
60.0458.15	150 - 15	2200	170 - 17	2450	1/2 Bsp F	B	1178	41,55	1	
60.0458.28	280 - 28	4050	310 - 31	4500	1/2 Bsp F	A	1222	43,1	1	

Rated Flow 80 l/min 21 USGpm
 Rated Temperature 70 °C 158 °F
 Material Stainless steel Ai316
 Seals material FKM (Viton)°
 Certification ATEX







VB 23 - AISI 303 -VITON/EPDM O-RINGS

P/N	Rated pr.		Permiss.press.		Seals material	Weight			
	bar - MPa	psi	bar - MPa	psi		gr	oz		
60.1400.00	280 - 28	4050	310 - 31	4500	FKM (Viton)°	978	34,49	1	
60.1420.18	280 - 28	4050	310 - 31	4500	Epdm	860	30,36	1	

Rated Flow 80 l/min 21 USGpm
 Rated Temperature 90 °C 195 °F
 Couplings 1/2 Bsp F
 Material Stainless steel 303





VB 26 - AISI 316 -VITON O-RINGS- UNLOADER VALVE

P/N	Rated pr.		Permiss.press.		Couplings	Weight			
	bar - MPa	psi	bar - MPa	psi		gr	oz		
60.1400.60	280 - 28	4050	310 - 31	4500	1/2 Bsp F	853	30,09	1	✓

Rated Flow 80 l/min 21 USGpm
 Rated Temperature 90 °C 195 °F
 Material Stainless steel Ai316
 Seals material FKM (Viton)°



VB 160/160-280 - UNLOADER VALVE -AIS I 303

P/N	Rated pr.		Permiss.press.		Couplings	Weight			
	bar - MPa	psi	bar - MPa	psi		gr	oz		
60.4600.00	160 - 16	2300	180 - 18	2600	3/4 Bsp F	2435	85,9	1	
60.4600.05	160 - 16	2300	180 - 18	2600	3/4 Npt F	2435	85,9	1	
60.4600.60	280 - 28	4050	310 - 31	4500	3/4 Bsp F	2530	89,2	1	
60.4600.65	280 - 28	4050	310 - 31	4500	3/4 Npt F	2530	89,2	1	

Rated Flow 160 l/min 42 USGpm
 Rated Temperature 90 °C 195 °F
 Material Stainless steel 303





PULSAR ZERO - VALVE WITH ZEROED OUTLET PRESSURE, IN BYPASS

P/N	Rated pr.		Permiss.press.		Inlet	Outlet	Bypass	Weight		12	✓
	bar - MPa	psi	bar - MPa	psi				gr	oz		
60.2400.00	280 - 28	4050	320 - 32	4550	3/8 Bsp F	3/8 Bsp F	2× 3/8Bsp F	1135	40,04	12	✓
60.2400.50	280 - 28	4050	320 - 32	4550	3/8 Npt F	3/8 Npt F	2× 3/8 Npt F	1135	40,04	12	✓
60.2435.00	350 - 35	5100	390 - 39	5650	3/8 Bsp F	3/8 Bsp F	2× 3/8Bsp F	1135	40,04	12	✓

Min. flow rate 9 l/min 2,4 USGpm
 Max. flow rate 40 l/min 10,5 USGpm
 Rated Temperature 60 °C 140 °F
 Max. Temper. 90 °C 195 °F
 Material Brass

Patent No.: I-1387704/-/US-2009-0205716-A1-/EP 2 093 643 A2-/ZL200810131662.7



VB 350 UNLOADER VALVE WITH KNOB

P/N	Inlet	Outlet	Bypass	Weight		5	✓
				gr	oz		
60.1700.00	3/8 Bsp M	3/8 Bsp F	1/2 Bsp F	920	32,45	5	✓
60.1700.50	3/8 Npt M	3/8 Npt F	1/2 Bsp F	926	32,66	5	✓

Rated Pressure 350 bar - 35 MPa 5100 psi
 Permissible Pressure 390 bar - 39 MPa 5650 psi
 Rated Flow 40 l/min 10,5 USGpm
 Rated Temperature 90 °C 195 °F
 Material Brass



VB 350 S

P/N	Inlet	Outlet	Bypass	Weight		20	✓
				gr	oz		
60.1750.00	3/8 Bsp M	3/8 Bsp F	1/2 Bsp F	880	31,04	20	✓
60.1800.00	3/8 Bsp M	3/8 Bsp F	1/2 Bsp F	970	34,21	1	✓

With MIN-MAX pressure setting



Rated Pressure 350 bar - 35 MPa 5100 psi
 Permissible Pressure 390 bar - 39 MPa 5650 psi
 Rated Flow 40 l/min 10,5 USGpm
 Rated Temperature 90 °C 195 °F
 Material Brass

Valves with replaceable Stainless steel shutter seat







VB 350 WITH KNOB AND MICROSWITCH

P/N	Inlet	Outlet	Bypass	Weight			
				gr	oz		
60.1730.00	3/8 Bsp M	3/8 Bsp F	3/8 Bsp F	1212	42,75	2	
Rated Pressure	350 bar - 35 MPa			5100 psi			
Permissible Pressure	390 bar - 39 MPa			5650 psi			
Rated Flow		40 l/min		10,5 USGpm			
Rated Temperature		90 °C		195 °F			
Max. Curr. Strength				6 (2) A			
Max. Voltage				250 V			
Material				Brass			





VB 36

P/N	Rated pr.		Permiss.press.		Couplings	Weight			
	bar - MPa	psi	bar - MPa	psi		gr	oz		
60.1860.00	350 - 35	5100	390 - 39	5650	1/2 Bsp F	884	31,18	4	
60.1860.50	350 - 35	5100	390 - 39	5650	1/2 Npt F	884	31,18	4	
Rated Flow		80 l/min		21 USGpm					
Rated Temperature		90 °C		195 °F					
Material				Brass					



VB36- HT 39MPA - UNLOADER VALVE FOR HOT TEMPERATURE WATER

P/N	Rated pr.		Permiss.press.		Couplings	Type	Weight			
	bar - MPa	psi	bar - MPa	psi			gr	oz		
60.1870.50	350 - 35	5100	390 - 39	5650	1/2 Npt F	A	1085	38,27	2	
Rated Flow		80 l/min		21 USGpm						
Rated Temperature		90 °C		195 °F						
Max. Temper.		85 °C		185 °F						
Material				Brass						





VB 80/150 - 280 - 400 - AISI 303

P/N	Rated pr.		Permiss.press.		Couplings	Type	CE Mark	Weight		✓	
	bar - MPa	psi	bar - MPa	psi				gr	oz		
60.0430.15	150 - 15	2200	170 - 17	2450	1/2 Bsp F	C	YES	1231	43,42	1	✓
60.0430.40	280 - 28	4050	310 - 31	4500	1/2 Bsp F	B	YES	1258	44,37	1	✓
60.0430.001	400 - 40	5800	450 - 45	6500	1/2 Bsp F	A	NO	1352	47,68	8	
60.0430.00	400 - 40	5800	450 - 45	6500	1/2 Bsp F	A	NO	1352	47,68	1	✓
60.0430.17	150 - 15	2200	170 - 17	2450	1/2 Npt F	C	YES	1199	42,29	1	
60.0430.45	280 - 28	4050	310 - 31	4500	1/2 Npt F	B	YES	1232	43,45	1	
60.0430.501	400 - 40	5800	450 - 45	6500	1/2 Npt F	A	NO	1330	47	8	
60.0430.50	400 - 40	5800	450 - 45	6500	1/2 Npt F	A	NO	1330	47	1	✓

Rated Flow 80 l/min 21 USGpm
 Rated Temperature 90 °C 195 °F
 Material Stainless steel 303



VB 80/150 - 280 - 400 - AISI 303 -VITON O-RINGS



P/N	Rated pr.		Permiss.press.		Type	CE Mark	Weight		✓	
	bar - MPa	psi	bar - MPa	psi			gr	oz		
60.0455.15	150 - 15	2200	170 - 17	2450	C	YES	1240	43,8	1	
60.0455.60	280 - 28	4050	310 - 31	4500	B	YES	1261	44,48	1	
60.0455.80	400 - 40	5800	450 - 45	6500	A	NO	1360	47,97	1	✓

Couplings 1/2 Bsp F
 Rated Flow 80 l/min 21 USGpm
 Rated Temperature 90 °C 195 °F
 Material Stainless steel 303
 Seals material FKM (Viton)*





VB 80/280- 400 - NORSOK- UNLOADER VAL. DUPLEX SST - VITON O-RINGS  

P/N	Rated pr.		Permissible Pressure		Type	CE Mark	Weight			
	bar - MPa	psi	bar - MPa	psi			gr	oz		
60.4450.28	280 - 28	4050	310 - 31	4500	B	YES	1275	45,1	1	
60.4450.40	400 - 40	5800	450 - 45	6500	A	YES	1360	47,97	1	

Couplings 1/2 Bsp F
 Rated Flow 80 l/min 21 USGpm
 Rated Temperature 70 °C 158 °F
 Material Stainless steel duplex
 Seals material FKM (Viton)
 Certification Norsok



VB 43 - AISI 303

P/N	Rated pr.		Permiss.press.		Mat.	Weight			
	bar - MPa	psi	bar - MPa	psi		gr	oz		
60.1450.00	400 - 40	5800	440 - 44	6400	Sst Ai 303	974	34,35	1	

Rated Flow 80 l/min 21 USGpm
 Rated Temperature 90 °C 195 °F
 Couplings 1/2 Bsp FF



VB23A-VB26A-VB33A- VB43A - VALV BYPASS ATEX

P/N	Rated pr.		Permiss.press.		Mat.	Type	Weight			
	bar - MPa	psi	bar - MPa	psi			gr	oz		
60.1853.00	280 - 28	4050	310 - 31	4500	Brass	A	1058	37,32	1	
60.1400.70	280 - 28	4050	310 - 31	4500	Sst Ai 303	B	978	34,49	1	
60.1400.80	280 - 28	4050	310 - 31	4500	Sst Ai 316L	C	853	30,09	1	
60.1455.00	400 - 40	5800	440 - 44	6400	Sst Ai 303	D	975	34,35	1	

Rated Flow 80 l/min 21 USGpm
 Rated Temperature 70 °C 158 °F
 Couplings 1/2 Bsp FF
 Certification ATEX

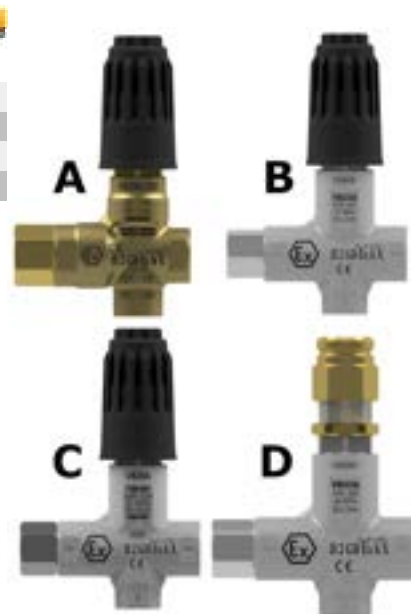



VB 16

P/N	Inlet	Outlet	Bypass	Weight		1	
				gr	oz		
60.8000.00	1/2 Bsp F	1/2 Bsp F	1/2 Bsp F	3608	127,26	1	
Rated Pressure	500 bar - 50 MPa			7250 psi			
Permissible Pressure	560 bar - 56 MPa			8100 psi			
Residual pressure at close	190 bar - 19 MPa			2750 psi			
Min.bypass re-start	110 bar - 11 MPa			1600 psi			
Rated Flow	80 l/min			21 USGpm			
Rated Temperature	90 °C			195 °F			
Material				Brass			

Patent No.: I 1262632- Usa 5,372,157- J 2749512



VB 53 - AISI 303

P/N	Rated pr.		Permiss.press.		Couplings	Weight		1	
	bar - MPa	psi	bar - MPa	psi		gr	oz		
60.1470.00	500 - 50	7250	550 - 55	8000	1/2 Bsp F	1036	36,54	1	
Rated Flow	80 l/min				21 USGpm				
Rated Temperature	90 °C				195 °F				
Material					Stainless steel				



VB 250/500 - UNLOADER VALVE AISI 303

P/N	Rated pr.		Permiss.press.		Couplings	Weight		1	
	bar - MPa	psi	bar - MPa	psi		gr	oz		
60.4500.00	500 - 50	7250	550 - 55	8000	1" Bsp F	7685	265	1	
Rated Flow	250 l/min				66 USGpm				
Rated Temperature	90 °C				195 °F				
Material					Stainless steel				





VB 83 - UNLOADER VALVE AISI 303

P/N	Couplings	Weight		1	✓
		gr	oz		
60.1630.00	1/2 Bsp F	2500	112,9	1	✓
Rated Pressure		800 bar - 80 MPa		11600 psi	
Permiss.press.		880 bar - 88 MPa		12800 psi	
Rated Flow		60 l/min		15,9 USGpm	
Rated Temperature		90 °C		195 °F	
Material				Stainless steel	



VB60/600-400-250 ZERO - VALVE WITH ZEROED OUTLET PRESSURE, IN BYPASS

P/N	Type	Permiss.press.		Inlet	Outlet	Bypass	Weight		1	✓
		bar - MPa	psi				gr	oz		
60.2600.25	C	250 - 25	3600	1/2 Bsp F	1/2 Bsp F	1/2 Bsp F	2090	73,8	1	✓
60.2600.40	B	400 - 40	5800	1/2 Bsp F	1/2 Bsp F	1/2 Bsp F	2125	75	1	✓
60.2600.00	A	600 - 60	8700	1/2 Bsp F	1/2 Bsp F	1/2 Bsp F	2107	74,32	1	✓
Min. flow rate			9 l/min		2,4 USGpm					
Max. flow rate			60 l/min		16 USGpm					
Rated Temperature			60 °C		140 °F					
Max. Temper.			90 °C		195 °F					
Material					Stainless steel 303					



Patent No.: I-1387704/-/US-2009-0205716-A1/-/EP 2 093 643 A2/-/ZL200810131662.7 / Eu 2093643

VB60/600 ZERO WITH MICRO-SWITCH- VALVE WITH ZEROED OUTLET PRESSURE, IN BYPASS 

P/N	Inlet	Outlet	Bypass	Weight		1	✓
				gr	oz		
60.2650.00	1/2 Bsp F	1/2 Bsp F	1/2 Bsp F	2250	79,4	1	✓
Permissible Pressure		600 bar - 60 MPa		8700 psi			
Max. flow rate		60 l/min		16 USGpm			
Min. flow rate		9 l/min		2,4 USGpm			
Rated Temperature		60 °C		140 °F			
Max. Temper.		90 °C		195 °F			
Material				Stainless steel 303			
Max. Curr. Strength				6 (2) A			
Max. Voltage				250 V			



Patent No.: I-1387704/-/US-2009-0205716-A1/-/EP 2 093 643 A2/-/ZL200810131662.7 / Eu 2093643



VB40/1000 ZERO - VALVE WITH ZEROED OUTLET PRESSURE, IN BYPASS

P/N	Inlet	Outlet	Bypass	Weight			
				gr	oz		
60.2900.00	3/8 Bsp F	3/8 Bsp F	3/8 Bsp F	4650	164	1	✓
60.2900.12	3/8 Bsp F	3/8 Bsp F	3/8 Bps M	4650	167,6	1	
Flow rate 9-15 litri/min							
60.2900.20	3/8 Bsp F	3/8 Bsp F	3/8 Bps M	4650	167,6	1	
Flow rate 15-25 litri/min							
60.2900.30	3/8 Bsp F	3/8 Bsp F	3/8 Bps M	4650	167,6	1	
Flow rate 25-35 litri/min							



Rated Pressure	1000 bar - 100 MPa	14500 psi
Permissible Pressure	1100 bar - 110 MPa	16000 psi
Min. flow rate	9 l/min	2,4 USGpm
Max. flow rate	40 l/min	10,5 USGpm
Rated Temperature	60 °C	140 °F
Max. Temper.	95 °C	203 °F
Material	Stainless steel 303	

Patent No.: I-1387704/-US-2009-0205716-A1/-EP 2 093 643 A2/-ZL200810131662.7 / Eu 2093643

STR -ADJUSTING BYPASS NEEDLE

P/N	Rated Flow		Rated pr.		Permiss.press.		Inlet	Outlet	Type	Weight			
	l/min	USGpm	bar - MPa	psi	bar - MPa	psi				gr	oz		
60.2620.00	25	6,5	70 - 7	1015	80 - 8	1150	3/8 Bsp M	3/8 Bsp F	A	428	15,1	2	✓
60.2631.31R							1/2 Bsp M	3/8 Bsp F	B	37	1,3	2	
60.2635.00	60	16	110 - 11	1600	120 - 12	1740	3/8 Bsp F	3/8 Bsp F	C	404	14,25	2	
13.5030.00R							1/2 Bsp M	3/8 Bsp M	D	72	2,5	25	✓
13.5025.00R							3/8 Bsp M	3/8 Bsp M	E	43	1,5	25	✓



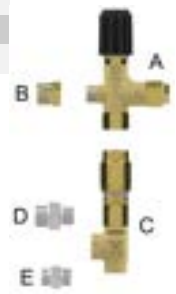

Outlet	3/8 Bsp F
Rated Temperature	90 °C
Material	Brass

Adjustable pressure restrictor for bypass water, in "Zero" valve.





VS 30

P/N	Inlet	Bypass	Weight			
			gr	oz		
60.0560.30	1/4 Bsp M	1/8Bsp F+13mm h.barb	133	4,69	10	
Rated Pressure	30 bar - 3 MPa		435 psi			
Permissible Pressure	35 bar - 3,5 MPa		510 psi			
Rated Flow	14 l/min		3,7 USGpm			
Rated Temperature	90 °C		195 °F			

The valves supplied are NOT PRESSURE ADJUSTED. They become a SAFETY device when adjusted by the installer on the machine. See Technical Manual.





VS 100 - AISI 316 - VITON O-RINGS

P/N	Rated pr.		Permiss.press.		Weight			
	bar - MPa	psi	bar - MPa	psi	gr	oz		
60.0470.60	125 - 12,5	1813	140 - 14	2300	402	14,18	4	
Rated Flow	20 l/min		5,3 USGpm					
Rated Temperature	90 °C		195 °F					
Inlet			1/4 Bsp F					
Bypass			1/4 Bsp F					
Material			Stainless steel Ai316					
Seals material			FKM (Viton)*					

The valves supplied are NOT PRESSURE ADJUSTED. They become a SAFETY device when adjusted by the installer on the machine. See Technical Manual.





VS 160

P/N	Inlet	Bypass	Weight			
			gr	oz		
60.0560.00	1/4 Bsp M	1/8Bsp F+13mm h.barb	138	4,87	10	
Rated Pressure	140 bar - 14 MPa		2000 psi			
Permissible Pressure	160 bar - 16 MPa		2300 psi			
Rated Flow	14 l/min		3,7 USGpm			
Rated Temperature	90 °C		195 °F			

The valves supplied are NOT PRESSURE ADJUSTED. They become a SAFETY device when adjusted by the installer on the machine. See Technical Manual.



VS 450-200

P/N	Inlet	Bypass	Weight			
			gr	oz		
60.4120.00	1" 1/4 Bsp F	1" 1/4 Bsp F	3848	135,72	1	
Rated Pressure	200 bar - 20 MPa		2900 psi			
Permissible Pressure	220 bar - 22 MPa		3200 psi			
Rated Flow	450 l/min		120 USGpm			
Rated Temperature	90 °C		195 °F			

The valves supplied are NOT PRESSURE ADJUSTED. They become a SAFETY device when adjusted by the installer on the machine. See Technical Manual.





VS 140 - VS 240

P/N	Rated pr.		Permiss.press.		Inlet	Weight			
	bar - MPa	psi	bar - MPa	psi		gr	oz		
60.1550.00	140 - 14	2000	180 - 18	2600	3/8 Bsp M	174	6,14	15	✓
60.1560.00	240 - 24	3500	290 - 29	4200	3/8 Bsp M	174	6,14	15	✓
60.1570.00	140 - 14	2000	180 - 18	2600	3/8 Npt M	174	6,14	15	✓
60.1580.00	240 - 24	3500	290 - 29	4200	3/8 Npt M	175	6,17	15	✓

Rated Flow 24 l/min 6,3 USGpm
 Rated Temperature 60 °C 140 °F
 Shutter Delrin ball

The valves supplied are NOT PRESSURE ADJUSTED. They become a SAFETY device when adjusted by the installer on the machine. See Technical Manual.



VS 170 - VS 220 -1 INLET PORT

P/N	Rated pr.		Permiss.press.		Weight			
	bar - MPa	psi	bar - MPa	psi	gr	oz		
60.0540.00	150 - 15	2200	170 - 17	2450	368	12,98	40	✓
60.0515.00	220 - 22	3200	250 - 25	3650	370	13,05	40	✓

Rated Flow 24 l/min 6,3 USGpm
 Rated Temperature 90 °C 195 °F
 Inlet 3/8 Bsp F
 Bypass 3/8 Bsp F

The valves supplied are NOT PRESSURE ADJUSTED. They become a SAFETY device when adjusted by the installer on the machine. See Technical Manual.



VS 170 - VS 220 - 2 INLET PORTS

P/N	Rated pr.		Permiss.press.		Bypass	Weight			
	bar - MPa	psi	bar - MPa	psi		gr	oz		
60.0528.00	150 - 15	2200	170 - 17	2450	3/8 Bsp F	406	14,2	40	✓
60.0525.00	220 - 22	3200	250 - 25	3650	3/8 Bsp F	406	14,2	40	✓
60.0525.15	220 - 22	3200	250 - 25	3650	1/4 Bsp M	389	13,72	40	✓
60.0530.00	150 - 15	2200	170 - 17	2450	3/8 Npt F	406	14,2	40	

Inlet ports : 2 × 3/8 Npt F

Rated Flow 24 l/min 6,3 USGpm
 Rated Temperature 90 °C 195 °F
 Inlet 2× 3/8 Bsp F

The valves supplied are NOT PRESSURE ADJUSTED. They become a SAFETY device when adjusted by the installer on the machine. See Technical Manual.



VS 200/200

P/N	Inlet	Bypass	Type	Weight			
				gr	oz		
60.5100.15	3/4 Bsp F	1/2 Bsp F	B	816	28,78	4	✓
60.5100.00	3/4 Npt F	1/2 Npt F	B	821	28,96	4	✓
60.5115.00	3/4 Bsp F	1/2 Bsp F	A	905	31,92	4	✓

Possibility to seal calibration

Rated Pressure 200 bar - 20 MPa 2900 psi
 Permissible Pressure 220 bar - 22 MPa 3200 psi
 Rated Flow 200 l/min 53 USGpm
 Rated Temperature 90 °C 195 °F

The valves supplied are NOT PRESSURE ADJUSTED. They become a SAFETY device when adjusted by the installer on the machine. See Technical Manual.

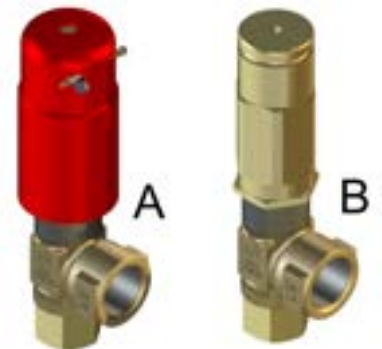

VS 28 / 1 - 2 - 3

P/N	Type	Rated Flow		Weight		10	✓
		l/min	USGpm	gr	oz		
60.0555.00	1	8 - 12	2,1 - 3,2	56	1,98	10	✓
60.0555.20	2	12 - 16	3,2 - 4,2	56	1,98	10	✓
60.0555.30	3	16 - 19,5	4,2 - 5,15	56	1,98	10	✓

Rated Pressure 100-250 bar 1450-3650 psi
 Rated Temperature 108 °C 225 °F
 Shutter Sst. ball
 Inlet 1/4 Bsp M
 Outlet 16mm hose barb



The valves supplied are NOT PRESSURE ADJUSTED. They become a SAFETY device when adjusted by the installer on the machine. See Technical Manual.

VS 28 / 1 - 2 PRESSURE ADJUSTED

P/N	Type	Rated Flow		Operat. press.		Weight		10	✓
		l/min	USGpm	bar - MPa	psi	gr	oz		
60.0555.15	1	8-12	2,1-3,2	165 - 16,5	2390	56	1,98	10	
60.0555.16	2	12-16	3,2-4,2	165 - 16,5	2390	56	1,98	10	✓
60.0555.22	2	12-16	3,2-4,2	220 - 22	3200	56	1,98	10	✓

Rated Temperature 108 °C 225 °F
 Shutter Sst. ball
 Inlet 1/4 Bsp M
 Outlet 16mm hose barb



The safety valves supplied are pressure adjusted (±3%) and sealed

VS 80/150 - AISI 303 ATEX

P/N	Rated pr.		Permiss.press.		Weight		1	✓
	bar - MPa	psi	bar - MPa	psi	gr	oz		
60.0593.00	150 - 15	2200	170 - 17	2450	1196	42,18	1	✓



Rated Flow 80 l/min 21 USGpm
 Rated Temperature 70 °C 158 °F
 Couplings 1/2 Bsp F
 Material Stainless steel 303
 Certification ATEX



The valves supplied are NOT PRESSURE ADJUSTED. They become a SAFETY device when adjusted by the installer on the machine. See Technical Manual.



VS 80/150-280 AISI 316 - VITON O-RINGS-ATEX  



P/N	Rated pr.		Permiss.press.		Type	Weight			
	bar - MPa	psi	bar - MPa	psi		gr	oz		
60.0590.00	150 - 15	2200	170 - 17	2450	B	1204	42,47	1	
60.0590.60	280 - 28	4050	310 - 31	4500	A	1238	43,67	1	

Rated Flow	80 l/min	21 USGpm
Rated Temperature	70 °C	158 °F
Couplings		1/2 Bsp F
Material		Stainless steel Ai316
Seals material		FKM (Viton)°
Certification		ATEX

The valves supplied are NOT PRESSURE ADJUSTED. They become a SAFETY device when adjusted by the installer on the machine. See Technical Manual.



VS 23 AI303- VS23- DUPLEX VS 26 - AISI 316 - VITON O-RINGS



P/N	Material	Rated pr.		Permiss.press.		Type	Weight			
		bar - MPa	psi	bar - MPa	psi		gr	oz		
60.1423.00R	Stainless steel 303	280 - 28	4050	310 - 31	4500	A	920	32,45	1	
60.1430.00	Stainless steel duplex	280 - 28	4050	310 - 31	4500	A	920	32,45	1	
60.1540.00	Stainless steel Ai316	280 - 28	4050	310 - 31	4500	B	856	30,19	1	

Rated Flow	80 l/min	21 USGpm
Rated Temperature	90 °C	195 °F
Inlet		1/2 Bsp F
Bypass		1/2 Bsp F
Seals material		FKM (Viton)°

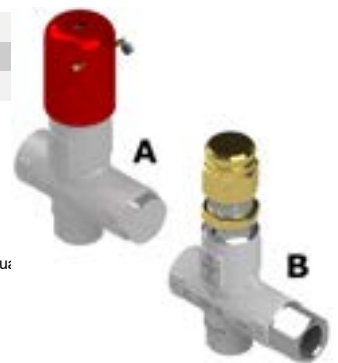
The valves supplied are NOT PRESSURE ADJUSTED. They become a SAFETY device when adjusted by the installer on the machine. See Technical Manu:





VS 450-300

P/N	Inlet	Bypass	Weight		1	
			gr	oz		
60.4130.00	1" 1/4 Bsp F	1" 1/4 Bsp F	3970	140,03	1	
Rated Pressure	300 bar - 30 MPa		4350 psi			
Permissible Pressure	330 bar - 33 MPa		4800 psi			
Rated Flow	450 l/min		120 USGpm			
Rated Temperature	90 °C		195 °F			

The valves supplied are NOT PRESSURE ADJUSTED. They become a SAFETY device when adjusted by the installer on the machine. See Technical Manual.





VS 310 -1 INLET PORT

P/N	Rated pr.		Permiss.press.		Weight		4	
	bar - MPa	psi	bar - MPa	psi	gr	oz		
60.0500.00	310 - 31	4500	350 - 35	5100	380	13,4	4	
Rated Flow	40 l/min		10,5 USGpm					
Rated Temperature	90 °C		195 °F					
Inlet			3/8 Bsp F					
Bypass			3/8 Bsp F					

The valves supplied are NOT PRESSURE ADJUSTED. They become a SAFETY device when adjusted by the installer on the machine. See Technical Manual.



VS 350

P/N	Inlet	Bypass	Type	Weight		25	
				gr	oz		
60.0580.00	2x 3/8 Bsp F	3/8 Bsp F	B	480	16,93	25	
60.0588.00	2x 3/8 Bsp F	3/8 Bsp F	A	526	18,55	25	



Possibility to seal calibration

Rated Pressure	350 bar - 35 MPa		5100 psi	
Permissible Pressure	390 bar - 39 MPa		5650 psi	
Rated Flow	25 l/min		6,5 USGpm	
Rated Temperature	90 °C		195 °F	

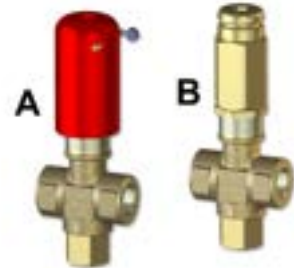
The valves supplied are NOT PRESSURE ADJUSTED. They become a SAFETY device when adjusted by the installer on the machine. See Technical Manual.



VS 360

P/N	Rated pr.		Permiss.press.		Weight		5	
	bar - MPa	psi	bar - MPa	psi	gr	oz		
60.1520.00	350 - 35	5100	390 - 39	5650	924	32,59	5	
Rated Flow	40 l/min		10,5 USGpm					
Rated Temperature	90 °C		195 °F					
Inlet			3/8 Bsp MF					
Bypass			1/2 Bsp F					

The valves supplied are NOT PRESSURE ADJUSTED. They become a SAFETY device when adjusted by the installer on the machine. See Technical Manual.





VS 24 - VS 43 - AISI 303

P/N	Rated pr.		Permiss.press.		Type	Weight			
	bar - MPa	psi	bar - MPa	psi		gr	oz		
60.1530.00	280 - 28	4050	310 - 31	4500	A	852	30,05	5	
60.1535.00	400 - 40	5800	440 - 44	6400	B	896	31,6	5	

Rated Flow 80 l/min 21 USGpm
 Rated Temperature 90 °C 195 °F
 Inlet 1/2 Bsp F
 Bypass 1/2 Bsp F
 Material Stainless steel 303

The valves supplied are NOT PRESSURE ADJUSTED. They become a SAFETY device when adjusted by the installer on the machine. See Technical Manual.



VS 26A - VS 43A - ATEX

P/N	Rated pr.		Permiss.press.		Mat.	Type	Weight			
	bar - MPa	psi	bar - MPa	psi			gr	oz		
60.1545.00	280 - 28	4050	310 - 31	4500	Sst Ai 316L	A	856	30,19	1	
60.1538.00	400 - 40	5800	440 - 44	6400	Sst Ai 303	B	896	31,6	1	

Rated Flow 80 l/min 21 USGpm
 Rated Temperature 70 °C 158 °F
 Inlet 1/2 Bsp F
 Bypass 1/2 Bsp F
 Certification ATEX

The valves supplied are NOT PRESSURE ADJUSTED. They become a SAFETY device when adjusted by the installer on the machine. See Technical Manual.



VS 80/400 - AISI 303 - ATEX

P/N	Inlet	Bypass	Certification	Weight			
				gr	oz		
60.0550.00	1/2 Bsp F	1/2 Bsp F	ATEX	1276	45	1	
60.0550.50	1/2 Npt F	1/2 Npt F	-	1250	44,3	1	

Rated Pressure 400 bar - 40 MPa 5800 psi
 Permissible Pressure 450 bar - 45 MPa 6500 psi
 Rated Flow 80 l/min 21 USGpm
 Rated Temperature 70 °C 158 °F
 Material Stainless steel 303

The valves supplied are NOT PRESSURE ADJUSTED. They become a SAFETY device when adjusted by the installer on the machine. See Technical Manual.



VS 80/280-400 - NORSOK -SST. DUPLEX - VITON O-RINGS

P/N	Rated pr.		Permiss.press.		Type	Weight			
	bar - MPa	psi	bar - MPa	psi		gr	oz		
60.4590.28	280 - 28	4050	310 - 31	4500	B	1304	45,99	1	
60.4590.40	400 - 40	5800	450 - 45	6500	A	1304	45,99	1	
Rated Flow	80 l/min		21 USGpm						
Rated Temperature	70 °C		158 °F						
Couplings			1/2 Bsp F						
Material			Stainless steel duplex						
Seals material			FKM (Viton)°						
Certification			Norsok						

The valves supplied are NOT PRESSURE ADJUSTED. They become a SAFETY device when adjusted by the installer on the machine. See Technical Manual.



VS 500-VS 500/310

P/N	Rated pr.		Permiss.press.		Type	Weight			
	bar - MPa	psi	bar - MPa	psi		gr	oz		
60.5200.00	500 - 50	7250	560 - 56	8100	B	1461	51,53	1	✓
60.5230.00	310 - 31	4500	350 - 35	4900	B	1461	51,53	1	✓
60.5212.00	500 - 50	7250	560 - 56	8100	A	1518	53,54	1	✓
Possibility to seal calibration									
60.5232.00	310 - 31	4500	350 - 35	4900	A	1518	53,54	1	
Possibility to seal calibration									

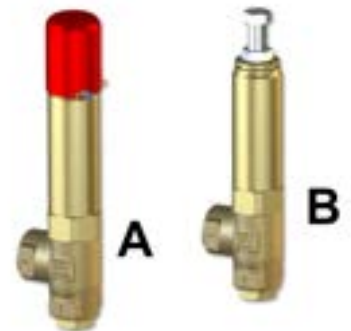

Rated Flow	80 l/min		21 USGpm						
Rated Temperature	90 °C		195 °F						
Inlet			1/2 Bsp F						
Bypass			3/8 Bsp F						

The valves supplied are NOT PRESSURE ADJUSTED. They become a SAFETY device when adjusted by the installer on the machine. See Technical Manual.





VS 500- PRESSURE ADJUSTED VALVE.



P/N	Operat. press.		Type	Weight		 
	bar - MPa	psi		gr	oz	
60.5212.30	300 - 30	4350	A	1518	53,54	1
Possibility to seal calibration						
60.5212.55	550 - 55	7950	A	1518	53,54	1
Possibility to seal calibration						

Rated Flow	80 l/min	21 USGpm
Rated Temperature	90 °C	195 °F
Inlet		1/2 Bsp F
Bypass		3/8 Bsp F

The valves supplied are PRESSURE ADJUSTED. See Technical Manual.





VS 500- SST

P/N	Rated pr.		Permiss.press.		Weight		 
	bar - MPa	psi	bar - MPa	psi	gr	oz	
60.0690.00	500 - 50	7250	560 - 56	8100	1300	45,85	1
Rated Flow		30 l/min		8 USGpm			
Rated Temperature		90 °C		195 °F			
Material				Stainless steel 303			
Inlet				3/8 Bsp F			
Bypass				3/8 Bsp F			

The valves supplied are NOT PRESSURE ADJUSTED. They become a SAFETY device when adjusted by the installer on the machine. See Technical Manual.



VS 660

P/N	Inlet	Bypass	Type	Weight		 
				gr	oz	
60.0650.00	3/8 Bspt F	1/2 Bspt F	B	1845	65	1
60.0645.00	3/8 Bspt F	1/2 Bspt F	A	1888	66,59	1

Rated Pressure	660 bar - 66 MPa	9500 psi
Permissible Pressure	720 bar - 72 MPa	10450 psi
Rated Flow	60 l/min	16 USGpm
Rated Temperature	90 °C	195 °F
Material		Sst.+ nick.pl. brass

The valves supplied are NOT PRESSURE ADJUSTED. They become a SAFETY device when adjusted by the installer on the machine. See Technical Manual.

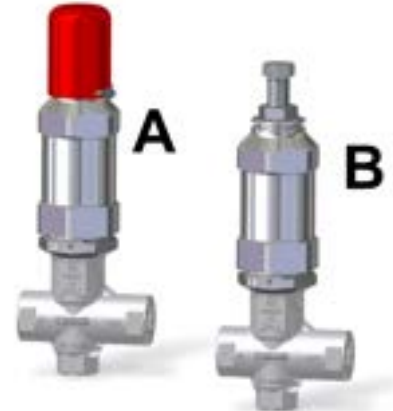

VS 1100

P/N	Inlet	Bypass	Type	Weight			
				gr	oz		
60.0680.00	3/8 Bsp F	3/8 Bsp F	A	2100	74	1	✓
Rated Pressure	1000 bar - 100 MPa			14500 psi			
Permissible Pressure	1200 bar - 120 MPa			17500 psi			
Min. operating pressure	200 bar - 20 MPa			2900 psi			
Rated Flow	40 l/min			10,6 USGpm			
Rated Temperature	100 °C			212 °F			
Max. working temperature	120 °C			248 °F			
Material				Sst.+ nick.pl. brass			

The valves supplied are NOT PRESSURE ADJUSTED. They become a SAFETY device when adjusted by the installer on the machine. See Technical Manual.



"VS 1200 FL" POP-OFF VALVE

P/N	Inlet	Bypass	Weight			
			gr	oz		
60.3000.00	3/8 Bsp F	3/8 Bsp F	2200	77,5	1	
Rated Pressure	1000 bar - 100 MPa		14500 psi			
Permissible Pressure	1200 bar - 120 MPa		17400 psi			
Min. operating pressure	200 bar - 20 MPa		2900 psi			
Rated Flow	40 l/min		10,6 USGpm			
Min.flow rate	9 l/min		2,4 USGpm			
Rated Temperature	60 °C		140 °F			
Max. working temperature	90 °C		195 °F			

The valves supplied are NOT PRESSURE ADJUSTED. They become a SAFETY device when adjusted by the installer on the machine. See Technical Manual.





VRP 175

P/N	Inlet	Bypass	Weight			
			gr	oz		
60.0545.00	2x 1" Bsp F	1" Bsp F	1956	68,99	1	✓
60.0545.50	2 x 1" Npt F	1" Npt F	1956	68,99	1	
Rated Pressure	150 bar - 15 MPa		2200 psi			
Permissible Pressure	170 bar - 17 MPa		2450 psi			
Rated Flow	200 l/min		53 USGpm			
Rated Temperature	90 °C		195 °F			



VRP 450-200

P/N	Inlet	Bypass	Weight			
			gr	oz		
60.4220.00	2x 1" 1/4 Bsp F	1" 1/2 Bsp F	5895	208	1	✓
Rated Pressure	200 bar - 20 MPa		2900 psi			
Permissible Pressure	220 bar - 22 MPa		3200 psi			
Rated Flow	450 l/min		120 USGpm			
Rated Temperature	90 °C		195 °F			





VRP 200

P/N	Rated pr.		Permiss.press.		Couplings	Weight			
	bar - MPa	psi	bar - MPa	psi		gr	oz		
60.0220.00	100 - 10	1450	120 - 12	1750	3/8 Bsp F	570	20,1	25	✓
60.0220.05	100 - 10	1450	120 - 12	1750	3/8 Npt F	556	19,61	25	✓
60.0220.60	220 - 22	3200	250 - 25	3650	3/8 Bsp F	605	21	25	✓
60.0220.65	220 - 22	3200	250 - 25	3650	3/8 Npt F	586	20,67	25	✓
Rated Flow	30 l/min		8 USGpm						
Rated Temperature	90 °C		195 °F						





VRP 280

P/N	Inlet	Outlet	Bypass	Weight			
				gr	oz		
60.0542.00	3/8 Bsp M	3/8 Bsp F	1/2 Bsp F	823	29	5	
Rated Pressure	280 bar - 28 MPa			4050 psi			
Permissible Pressure	310 bar - 31 MPa			4500 psi			
Rated Flow	40 l/min			10,5 USGpm			
Rated Temperature	90 °C			195 °F			





VRP 26 - AISI 316 - VITON O-RINGS

P/N	Rated pr.		Permiss.press.		Weight			
	bar - MPa	psi	bar - MPa	psi	gr	oz		
60.0675.00	280 - 28	4050	310 - 31	4500	836	29,51	1	
Rated Flow	80 l/min			21 USGpm				
Rated Temperature	90 °C			195 °F				
Couplings				1/2 Bsp F				
Material			Stainless steel AISI 316					
Seals material			FKM (Viton)°					





VRP 450-300

P/N	Inlet	Bypass	Weight			
			gr	oz		
60.4230.00	2× 1" 1/4 Bsp F	1" 1/2 Bsp F	5980	197	1	
Rated Pressure	300 bar - 30 MPa		4350 psi			
Permissible Pressure	330 bar - 33 MPa		4800 psi			
Rated Flow	450 l/min		120 USGpm			
Rated Temperature	90 °C		195 °F			



VRP 350

P/N	Inlet	Outlet	Bypass	Weight			
				gr	oz		
60.0660.00	3/8 Bsp M	3/8 Bsp F	1/2 Bsp F	823	29	1	
Rated Pressure	350 bar - 35 MPa			5100 psi			
Permissible Pressure	390 bar - 39 MPa			5650 psi			
Rated Flow	40 l/min			10,5 USGpm			
Rated Temperature	90 °C			195 °F			





VRP 23 - VRP 43 - AISI 303

P/N	Rated pr.		Permiss.press.		Type	Weight				
	bar - MPa	psi	bar - MPa	psi		gr	oz			
60.0665.00	280 - 28	4050	310 - 31	4500	A	930	32,8	1		
60.0670.00	400 - 40	5800	440 - 44	6400	B	958	33,79	1		
Rated Flow			80 l/min			21 USGpm				
Rated Temperature			90 °C			195 °F				
Couplings					1/2 Bsp F					
Material					Stainless steel 303					



VRP 600

P/N	Inlet	Bypass	Weight			
			gr	oz		
60.5400.00	1/2 Bsp F	1/2 Bsp F	950	33,51	1	
Rated Pressure	560 bar - 56 MPa		8100 psi			
Permissible Pressure	600 bar - 60 MPa		8700 psi			
Rated Flow	80 l/min		21 USGpm			
Rated Temperature	90 °C		195 °F			
Material			Stainless steel 303			



VRPP 170 AIR-CONTROLLED

P/N	Inlet	Outlet	Bypass	Weight		1		
				gr	oz			
60.5300.00	1 Bsp F	1" Bsp F	1" Bsp F	4015	141,7	1		
Rated Pressure		150 bar - 15 MPa						
Permissible Pressure		170 bar - 17 MPa						
Rated Flow		200 l/min						
Rated Temperature		90 °C						
Required air pressure		6 bar - 0,6 MPa						
Compressed air fitting								



VRPP 450-200 AIR-CONTROLLED

P/N	Inlet	Outlet	Bypass	Weight		1		
				gr	oz			
60.5360.00	1" 1/4 Bsp F	1" 1/4 Bsp F	1" 1/4 Bsp F	8546	301,42	1		
Rated Pressure		200 bar - 20 MPa						
Permissible Pressure		220 bar - 22 MPa						
Rated Flow		450 l/min						
Rated Temperature		90 °C						
Required air pressure		6 bar - 0,6 MPa						
Compressed air fitting								





VRPP 33 - HT AIR-CONTROLLED

P/N	Inlet	Outlet	Bypass	Weight		1		
				gr	oz			
60.5333.00	1/2 Bsp F	1/2 Bsp F	1/2 Bsp F	3784	133,47	1		
Rated Pressure		280 bar - 28 MPa						
Permissible Pressure		310 bar - 31 MPa						
Rated Flow		80 l/min						
Rated Temperature		90 °C						
Max. Temper.		85 °C						
Material								
Required air pressure		6 bar - 0,6 MPa						
Compressed air fitting								







VRPP 26 - AISI316 AIR-CONTROLLED

P/N	Inlet	Outlet	Bypass	Weight		1		
				gr	oz			
60.5350.00	1/2 Bsp F	1/2 Bsp F	1/2 Bsp F	3784	133,47	1		
Rated Pressure		280 bar - 28 MPa			4050 psi			
Permissible Pressure		310 bar - 31 MPa			4500 psi			
Rated Flow		80 l/min			21 USGpm			
Rated Temperature		90 °C			196 °F			
Material					Stainless steel AISI316			
Required air pressure		6 bar - 0,6 MPa			87 psi			
Compressed air fitting					1/4 Bsp F			





VRPP 200-280 AIR-CONTROLLED

P/N	Inlet	Outlet	Bypass	Weight		1		
				gr	oz			
60.5330.00	1 Bsp F	1" Bsp F	1" Bsp F	5386	189,97	1		
Rated Pressure		280 bar - 28 MPa			4050 psi			
Permissible Pressure		310 bar - 31 MPa			4500 psi			
Rated Flow		200 l/min			53 USGpm			
Rated Temperature		90 °C			196 °F			
Required air pressure		6 bar - 0,6 MPa			87 psi			
Compressed air fitting					1/4 Bsp F			



VRPP 600 - AISI 303 AIR-CONTROLLED

P/N	Inlet	Outlet	Bypass	Weight		1		
				gr	oz			
60.5450.00	1/2 Bsp F	1/2 Bsp F	1/2 Bsp F	3820	134,73	1		
Rated Pressure		560 bar - 56 MPa			8100 psi			
Permissible Pressure		600 bar - 60 MPa			8700 psi			
Rated Flow		80 l/min			21 USGpm			
Rated Temperature		90 °C			195 °F			
Required air pressure		6 bar - 0,6 MPa			87 psi			
Compressed air fitting					1/4 Bsp F			



VNR - O BRASS CHECK VALVE

P/N	Rated Flow		Rated Ø	Couplings	Weight		15	✓
	l/min	USGpm			gr	oz		
60.2040.00	25	6,5	8	1/4 Bsp FF	58	2,05	15	✓
60.2050.00	40	10,5	10	3/8 Bsp FF	112	3,95	15	✓
60.2065.00	80	21	15	1/2 Bsp FF	200	7,1	15	✓
60.2075.00	180	47,6	20	3/4 Bsp FF	370	13,1	15	✓

Rated Pressure 150 bar - 15 MPa 2200 psi
 Permissible Pressure 160 bar - 16 MPa 2300 psi
 Rated Temperature 90 °C 195 °F
 Material Brass



VNR - OHD BRASS CHECK VALVE

P/N	Rated Flow		Rated Ø	Couplings	Weight		10	✓
	l/min	USGpm			gr	oz		
60.2100.00	25	6,5	8	1/4 Bsp FF	114	4	10	✓
60.2120.00	40	10,5	10	3/8 Bsp FF	192	6,8	10	✓
60.2140.00	80	21	15	1/2 Bsp FF	446	15,7	10	✓
60.2150.00	140	37	20	3/4 Bsp FF	822	28,99	2	✓
60.2160.00	200	53	25	1" Bsp F	1348	47,55	1	✓
60.2170.00	450	120	32	1"1/4 Bsp FF	1954	68,92	1	✓

Rated Pressure 280 bar - 28 MPa 4000 psi
 Permissible Pressure 310 bar - 31 MPa 4500 psi
 Rated Temperature 90 °C 195 °F
 Material Brass



VNR - IHD- STAINLESS STEEL CHECK VALVE

P/N	Rated Flow		Rated Ø	Couplings	Weight		2	✓
	l/min	USGpm			gr	oz		
60.2145.00	80	21	15	1/2 Bsp FF	544	19,19	2	✓

Rated Pressure 350 bar - 35 MPa 5000 psi
 Permissible Pressure 390 bar - 39 MPa 5650 psi
 Rated Temperature 90 °C 195 °F
 Material Stainless steel



VNR - I STAINLESS STEEL CHECK VALVE

P/N	Rated Flow		Rated Ø	Couplings	Seals material	Weight		15	✓
	l/min	USGpm				gr	oz		
60.2030.00	25	6,5	8	1/4 Bsp FF	FKM (Viton)°	54	1,9	15	✓
60.2010.18	25	6,5	8	1/4 Bsp FF	Epdm	54	1,9	15	✓
60.2030.50	25	6,5	8	1/4 Npt FF	FKM (Viton)°	54	1,9	15	✓
60.2020.00	40	10,5	10	3/8 Bsp FF	FKM (Viton)°	104	3,7	15	✓
60.2020.50	40	10,5	10	3/8 Npt FF	FKM (Viton)°	104	3,7	15	✓
60.2070.00	80	21	15	1/2 Bsp FF	FKM (Viton)°	188	6,63	15	✓
60.2070.50	80	21	15	1/2 Npt FF	FKM (Viton)°	193	6,81	15	✓
60.2080.00	180	47,6	20	3/4 Bsp FF	FKM (Viton)°	344	12,13	15	✓

Rated Pressure 400 bar - 40 MPa 5800 psi
 Permissible Pressure 450 bar - 45 MPa 6500 psi
 Rated Temperature 90 °C 195 °F
 Material Stainless steel





RF1 - FLOW REGULATOR **NEW**

P/N	Inlet	Outlet	Weight		10	✓
			gr	oz		
29.0400.10	1/4 Bsp M	1/4 Bsp F	186	6,56	10	✓
Rated Pressure	250 bar - 25 MPa		3650 psi			
Permissible Pressure	280 bar - 28 MPa		4050 psi			
Rated Flow	30 l/min		8 USGpm			
Rated Temperature	160 °C		320 °F			

Throttling regulator for adjustable flow control



RV1- STEAM VALVE

P/N	Nozzle Size	Couplings	Col.	Weight		10	✓
				gr	oz		
29.0920.08	01	1/4 Bsp MM	Red	163	5,75	10	
29.0920.12	02	1/4 Bsp MM	Red	162	5,71	10	✓
29.0920.82	02	1/4 Bsp MM	Blue	162	5,71	10	
29.0920.15	03	1/4 Bsp MM	Red	162	5,71	10	✓
29.0920.65	03	1/4 Bsp MM	Black	155	5,4	10	
29.0920.85	03	1/4 Bsp MM	Blue	163	5,75	10	
29.0920.20	043	1/4 Bsp MM	Red	162	5,71	10	✓
29.0920.70	043	1/4 Bsp MM	Black	163	5,75	10	✓

Panel fitting	17 mm	3/4" in
Rated Pressure	250 bar - 25 MPa	3650 psi
Permissible Pressure	280 bar - 28 MPa	4050 psi
Rated Temperature	80 °C	175 °F

Throttling nozzle for bypass flow control



ES1 -EASY STARTER

P/N	Inlet	Hose barb		Weight		15	✓
		mm	in	gr	oz		
29.0100.60	1/4 Bsp M	8	1/4	126	4,44	15	✓
29.0100.50	3/8 Bsp M	8	1/4	134	4,73	15	✓
29.0100.00	3/8 Npt M	8	1/4	136	4,8	15	✓

Rated Pressure	280 bar - 28 MPa	4050 psi
Permissible Pressure	310 bar - 31 MPa	4500 psi
Rated Flow	30 l/min	8 USGpm
Rated Temperature	80 °C	175 °F

It delays pressure increase by pump start.



RG1 - THROTTLE CONTROL



P/N	Working press.		Stroke		Weight		5	✓
	bar	psi	mm	in	gr	oz		
29.0120.00	15-250	218-3650	7	0,27	140	4,94	5	✓
29.0130.00	15-250	218-3650	14	0,54	158	5,57	5	✓

Rated Pressure	250 bar - 25 MPa	3650 psi
Permissible Pressure	280 bar - 28 MPa	4050 psi
Rated Temperature	160 °C	320 °F
Inlet		1/4 Bsp M

For engine motors - It slows RPM down when bypass is activated





RGV - THROTTLE CONTROL-ADJUSTABLE STROKE

P/N	Working press.		Stroke		Weight		 
	bar	psi	mm	in	gr	oz	
29.0410.00	7-350	100-5100	7-15	0,28-0,55	260	9,21	5
Rated Pressure	350 bar - 35 MPa				5100 psi		
Permissible Pressure	390 bar - 39 MPa				5650 psi		
Rated Temperature	160 °C				320 °F		
Max. working temperature	90 °C				195 °F		
Inlet					1/4 Bsp M		

For engine motors - It slows RPM down when bypass is activated



RGV 500 - THROTTLE CONTROL-ADJUSTABLE STROKE

P/N	Working press.		Stroke		Weight		 
	bar	psi	mm	in	gr	oz	
29.0420.00	7-550	100-8000	7-15	0,28-0,55	162	5,71	5
Rated Pressure	500 bar - 50 MPa				7300 psi		
Permissible Pressure	550 bar - 55 MPa				8000 psi		
Rated Temperature	160 °C				320 °F		
Max. working temperature	90 °C				195 °F		
Inlet					1/4 Bsp M		

For engine motors - It slows RPM down when bypass is activated





RL 124

P/N	Inlet	Outlet	Weight		1	
			gr	oz		
30.5300.00	1/2 Bsp F	1/2 Bsp F	1280	45,15	1	
Rated Pressure	120 bar - 12 MPa		1750 psi			
Permissible Pressure	135 bar - 13,5 MPa		1950 psi			
Rated Flow	120 l/min		32 USGpm			
Rated Temperature	100 °C		210 °F			
Extensions			30.4000.40-80			



RL124 LANCE AND NOZZLE HOLDER

P/N	Length		Inlet	Outlet	Type	Weight		1	
	mm	in.				gr	oz		
30.4000.40	400	15,7	1/2 Bsp M	1/4 Npt F	A	745	26,28	1	
30.4000.80	800	31,5	1/2 Bsp M	1/4 Npt F	A	1264	44,58	1	
30.5018.61R			Nipple 1/2 Bsp M	1/4 Npt F	B	55	2	1	
Nozzle holder									
Rated Pressure	120 bar - 12 MPa		1750 psi						
Permissible Pressure	135 bar - 13,5 MPa		1950 psi						
Rated Flow	120 l/min		32 USGpm						
Rated Temperature	43 °C		109 °F						
Material			Zinc plated steel						



RL 34 + SW - FOAM GUN - WIDE PASSAGES

P/N	Inlet	Outlet	Weight		2	
			gr	oz		
30.2900.00	+ sw. 1/2 Bsp F	1/2 Bsp F	645	22,75	2	
Inlet with swivel						
Rated Pressure	180 bar - 18 MPa		2600 psi			
Permissible Pressure	200 bar - 20 MPa		2900 psi			
Rated Flow	80 l/min		21 USGpm			
Rated Temperature	160 °C		320 °F			
Material			Brass			

Brass spray gun, with wider inner passages



RL 82 + SW - SST FOAM GUN

P/N	Inlet	Outlet	Weight		2	
			gr	oz		
30.2800.00	+ sw. 1/2 Bsp F	1/2 Bsp F	616	21,73	2	
Inlet with swivel						
Rated Pressure	180 bar - 18 MPa		2600 psi			
Permissible Pressure	200 bar - 20 MPa		2900 psi			
Rated Flow	80 l/min		21 USGpm			
Rated Temperature	160 °C		320 °F			
Material			Stainless steel			

Sst spray gun, with wider inner passages





RL 86 + SW - SST AI 316 FOAM GUN

P/N	Inlet	Outlet	Weight		Icons	Status
			gr	oz		
30.2830.60	+ sw. 1/2 Bsp F	1/2 Bsp F	626	22,08	2	✓
Inlet with swivel						
Rated Pressure	180 bar - 18 MPa		2600 psi			
Permissible Pressure	200 bar - 20 MPa		2900 psi			
Rated Flow	80 l/min		21 USGpm			
Rated Temperature	160 °C		320 °F			
Material	Stainless steel Ai316					

Sst spray gun, with wider inner passages



RL 16

P/N	Inlet	Outlet	Weight		Icons	Status
			gr	oz		
30.0000.20	1/4 Bsp F	1/4 Bsp F	256	9,03	20	✓
30.0000.40	1/4 Bsp M	1/4 Bsp F	256	9,03	20	✓
30.0000.00	3/8 Bsp F	1/4 Bsp F	270	9,52	20	✓
30.0000.50	3/8 Npt F	1/4 Npt F	269	9,49	20	✓
30.0000.45	A M22	1/4 Bsp F	270	9,52	20	
Rated Pressure	160 bar - 16 MPa		2300 psi			
Permissible Pressure	175 bar - 17,5 MPa		2550 psi			
Rated Flow	30 l/min		8 USGpm			
Rated Temperature	100 °C		210 °F			



RL 11

P/N	Inlet	Outlet	Weight		Icons	Status
			gr	oz		
30.0800.00	3/8 Bsp F	1/4 Bsp F	434	15,31	20	
30.0800.20	A M22	1/4 Bsp F	431	15,2	20	
Rated Pressure	160 bar - 16 MPa		2300 psi			
Permissible Pressure	175 bar - 17,5 MPa		2550 psi			
Rated Flow	30 l/min		8 USGpm			
Rated Temperature	100 °C		210 °F			



LINEAR 100/170

P/N	Inlet	Outlet	Weight		Icons	Status
			gr	oz		
30.0650.00	1/2 Bsp F	1/2 Bsp F	1176	41,48	1	
30.0650.50	1/2 Npt F	1/2 Npt F	1176	41,48	1	✓
Rated Pressure	170 bar - 17 MPa		2500 psi			
Permissible Pressure	190 bar - 19 MPa		2800 psi			
Rated Flow	100 l/min		27 USGpm			
Rated Temperature	100 °C		210 °F			





RL 20

P/N	Inlet	Outlet	Weight		20	✓
			gr	oz		
30.0100.20	1/4 Bsp F	1/4 Bsp F	262	9,24	20	✓
30.0100.30	1/4 Bsp M	1/4 Bsp F	256	9,03	20	
30.0100.00	3/8 Bsp F	1/4 Bsp F	272	9,59	20	✓
30.0100.60	3/8 Bsp M	1/4 Bsp F	265	9,3	20	✓
30.0100.40	A M22	1/4 Bsp F	280	9,87	20	
30.0100.50	3/8 Npt F	1/4 Npt F	276	9,73	20	✓

Rated Pressure	200 bar - 20 MPa	2900 psi
Permissible Pressure	220 bar - 22 MPa	3200 psi
Rated Flow	30 l/min	8 USGpm
Rated Temperature	160 °C	320 °F



RP30/160 - RP80/160 - RP120/160 - PNEUMATIC ON-OFF GUNS

P/N	Rated Flow		Inlet	Outlet	Weight		1	✓
	l/min	USGpm			gr	oz		
30.3280.00	30	8	1/4 Bsp F	1/4 Bsp F	548	19,33	1	✓
30.3260.00	80	21	1/2 Bsp F	1/2 Bsp F	1080	38,1	1	✓
30.3200.00	120	32	3/4 Bsp F	3/4 Bsp F	1862	65,61	1	✓

Rated Pressure	160 bar - 16 MPa	2300 psi
Permissible Pressure	175 bar - 17,5 MPa	2550 psi
Rated Temperature	90 °C	195 °F
Required air pressure	7 bar - 0,7 MPa	101 psi
Compressed air fitting		1/4 Bsp F



RP200/200 - PNEUMATIC ON-OFF GUNS **NEW**

P/N	Rated Flow		Inlet	Outlet	Weight		1
	l/min	USGpm			gr	oz	
30.3240.00	200	53	1 Bsp F	1" Bsp F	2400	49,38	1

Rated Pressure	200 bar - 20 MPa	2900 psi
Permissible Pressure	220 bar - 22 MPa	3200 psi
Rated Temperature	90 °C	195 °F
Required air pressure	7 bar - 0,7 MPa	101 psi
Compressed air fitting		1/4 Bsp F



RL 204

P/N	Inlet	Outlet	Weight		1	✓
			gr	oz		
30.5200.00	3/4 Bsp F	1/2 Bsp F	1331	46,94	1	✓
Rated Pressure		200 bar - 20 MPa		2900 psi		
Permissible Pressure		220 bar - 22 MPa		3200 psi		
Rated Flow		200 l/min		53 USGpm		
Rated Temperature		100 °C		210 °F		
Extensions			30.5000.40-80-92			



RL 204 + SW.5

P/N	Inlet	Outlet	Weight		1
			gr	oz	
30.5230.00	+ sw.5 3/4Bsp F	1/2 Bsp F	1348	47,5	1
Rated Pressure		200 bar - 20 MPa		2900 psi	
Permissible Pressure		220 bar - 22 MPa		3200 psi	
Rated Flow		200 l/min		53 USGpm	
Rated Temperature		100 °C		210 °F	
Extensions			30.5000.40-80-92		



LINEAR 80/210 **NEW**

P/N	Inlet	Outlet	Weight		1	✓
			gr	oz		
30.0690.50	1/2 Npt F	1/2 Npt F	1222	431	1	✓
Rated Pressure		210 bar - 21 MPa		3050 psi		
Permissible Pressure		230 bar - 23 MPa		3340 psi		
Rated Flow		80 l/min		21 USGpm		
Rated Temperature		100 °C		210 °F		





RL 26

P/N	Inlet	Outlet	Weight		20	
			gr	oz		
30.1755.15	1/4 Bsp M	1/4 Bsp F	390	13,65	20	
30.1755.00	3/8 Bsp M	1/4 Bsp F	394	13,9	20	✓
30.1755.30	3/8 Bsp F	1/4 Bsp F	404	14,25	20	✓
30.1755.50	3/8 Npt F	1/4 Npt F	400	14,11	20	✓
30.1755.60	A M22	1/4 Bsp F	409	14,43	20	✓
30.1756.00	1/4 Bsp F	1/4 Bsp F	446	15,73	20	✓

With ceramic ball - Suitable for chlore

Rated Pressure	250 bar - 25 MPa	3650 psi
Permissible Pressure	280 bar - 28 MPa	4050 psi
Rated Flow	30 l/min	8 USGpm
Rated Temperature	160 °C	320 °F



RL 26 + SW6 / SW8

P/N	Inlet	Outlet	Weight		20	
			gr	oz		
30.1772.00	+ sw.8 3/8 Bsp F	1/4 Bsp F	480	16,93	20	✓
30.1758.00	+ sw.6 3/8 Bsp F	1/4 Bsp F	476	16,79	20	✓

Rated Pressure	250 bar - 25 MPa	3650 psi
Permissible Pressure	280 bar - 28 MPa	4050 psi
Rated Flow	30 l/min	8 USGpm
Rated Temperature	160 °C	320 °F



RL 27 - FOR T LABEL

P/N	Inlet	Outlet	Weight		20	
			gr	oz		
30.1800.00	3/8 Bsp F	1/4 Bsp F	404	14,25	20	

Rated Pressure	250 bar - 25 MPa	3650 psi
Permissible Pressure	280 bar - 28 MPa	4050 psi
Rated Flow	30 l/min	8 USGpm
Rated Temperature	160 °C	320 °F



RL 27+ SW8 SPRAY GUN -FOR LABEL NEW

P/N	Inlet	Outlet	Weight		20	
			gr	oz		
30.1830.00	+ sw.8 3/8 Bsp F	1/4 Bsp F	480	16,93	20	

Rated Pressure	250 bar - 25 MPa	3650 psi
Permissible Pressure	280 bar - 28 MPa	4050 psi
Rated Flow	30 l/min	8 USGpm
Rated Temperature	160 °C	320 °F



RL 27+ SW6 / SW8 SPRAY GUN -PA **NEW**

P/N	Inlet	Outlet	Weight		Icons
			gr	oz	
30.1820.90	+ sw.6 3/8 Bsp F	1/4 Bsp F	476	16,79	20
30.1830.90	+ sw.8 3/8 Bsp F	1/4 Bsp F	480	16,93	20
Rated Pressure	250 bar - 25 MPa		3650 psi		
Permissible Pressure	280 bar - 28 MPa		4050 psi		
Rated Flow	30 l/min		8 USGpm		
Rated Temperature	160 °C		320 °F		



RL 51

P/N	Inlet	Outlet	Weight		Icons
			gr	oz	
30.4100.10	3/8 Bsp F	1/4 Bsp F	684	24,13	8 ✓
30.4100.60	3/8 Npt F	1/4 Npt F	684	24,13	8 ✓
30.4120.10	+ sw. 3/8 Bsp F	1/4 Bsp F	776	27,37	8 ✓
Rated Pressure	250 bar - 25 MPa		3650 psi		
Permissible Pressure	280 bar - 28 MPa		4050 psi		
Rated Flow	50 l/min		13,2 USGpm		
Rated Temperature	160 °C		320 °F		



With a new, improved mechanical device with double connecting rod

LINEAR 120/280

P/N	Inlet	Outlet	Weight		Icons
			gr	oz	
30.0680.00	1/2 Bsp F	1/2 Bsp F	1224	43,17	1
30.0680.501	1/2 Npt F	1/2 Npt F	1224	43,17	7
30.0680.50	1/2 Npt F	1/2 Npt F	1224	43,17	1 ✓
Max. flow rate	120 l/min		32 USGpm		
Rated Pressure	280 bar - 28 MPa		4050 psi		
Permissible Pressure	310 bar - 31 MPa		4500 psi		
Rated Temperature	100 °C		210 °F		





RF 120/280 - FOOT VALVE

P/N	Max. flow rate		Inlet	Outlet	Weight		Icons
	l/min	USGpm			gr	oz	
30.5250.00	120	32	3/4 Bsp F	3/4 Bsp F	7499	264,5	1
30.5250.50	120	32	3/4 Npt F	3/4" Npt F	7499	264,5	1
Rated Pressure	280 bar - 28 MPa				4050 psi		
Permissible Pressure	310 bar - 31 MPa				4500 psi		
Rated Temperature	90 °C				195 °F		









RP 120/280 PNEUMATIC ON-OFF GUN

P/N	Max. flow rate		Inlet	Outlet	Weight		 
	l/min	USGpm			gr	oz	
30.3230.00	120	32	3/4 Bsp F	3/4 Bsp F	2398	84,58	1 
Rated Pressure	280 bar - 28 MPa				4050 psi		
Permissible Pressure	310 bar - 31 MPa				4500 psi		
Rated Temperature	90 °C				195 °F		
Required air pressure	7 bar - 0,7 MPa				101 psi		
Compressed air fitting					1/4 Bsp F		





RL 36

P/N	Inlet	Outlet	Weight		 	
			gr	oz		
30.1530.00	3/8 Bsp F	1/4 Bsp F	565	20	15 	
30.1530.30	3/8 Bsp M	1/4 Bsp F	555	19,6	15 	
30.1530.50	3/8 Npt F	1/4 Npt F	565	20	15 	
Rated Pressure	280 bar - 28 MPa				4000 psi	
Permissible Pressure	310 bar - 31 MPa				4500 psi	
Rated Flow	30 l/min				8 USGpm	
Rated Temperature	160 °C				320 °F	



RL 36 + SW 8

P/N	Inlet	Outlet	Weight		 	
			gr	oz		
30.1550.00	+ sw.8 3/8 Bsp F	1/4 Bsp F	656	23,14	15 	
Rated Pressure	280 bar - 28 MPa				4000 psi	
Permissible Pressure	310 bar - 31 MPa				4500 psi	
Rated Flow	30 l/min				8 USGpm	
Rated Temperature	160 °C				320 °F	



RL 22

P/N	Inlet	Outlet	Weight			
			gr	oz		
30.0400.00	3/8 Bsp F	1/4 Bsp F	475	16,8	20	✓
Rated Pressure		310 bar - 31 MPa			4500 psi	
Permissible Pressure		350 bar - 35 MPa			5000 psi	
Rated Flow		40 l/min			10,5 USGpm	
Rated Temperature		160 °C			320 °F	



RL 22 - HIGH TEMPERATURE-CERAMIC BALL- VITON SEALS

P/N	Inlet	Outlet	Weight			
			gr	oz		
30.0485.00	3/8 Bsp F	1/4 Bsp F	475	16,8	20	✓
With ceramic ball +or vit.- Suitable for chlore (30.0485.00)						
Rated Pressure		310 bar - 31 MPa			4500 psi	
Permissible Pressure		350 bar - 35 MPa			5000 psi	
Rated Flow		40 l/min			10,5 USGpm	
Rated Temperature		160 °C			320 °F	
Seals material					FKM (Viton)°	



RL 22 -HIGHT TEMPERATURE- QUICK COUPL.REINFORCED- VITON SEALS

P/N	Inlet	Outlet	Weight			
			gr	oz		
30.0490.00	3/8 Bsp M	AR 3/23 B M22 ex	650	23	10	
With ceramic ball +or vit.- Suitable for chlore (30.0485.00)						
Rated Pressure		310 bar - 31 MPa			4500 psi	
Permissible Pressure		350 bar - 35 MPa			5000 psi	
Rated Flow		40 l/min			10,5 USGpm	
Rated Temperature		160 °C			320 °F	
Seals material					FKM (Viton)°	
Extensions					40.2590.00	



RL 22 + SW8

P/N	Inlet	Outlet	Weight			
			gr	oz		
30.0420.00	+ sw.8 3/8 Bsp F	1/4 Bsp F	574	20,25	20	✓
30.0420.12	+ sw.8 3/8 Bsp F	1/4 Bsp F	750	26,5	20	
Sw8 sst pin						
Rated Pressure		310 bar - 31 MPa			4500 psi	
Permissible Pressure		350 bar - 35 MPa			5000 psi	
Rated Flow		40 l/min			10,5 USGpm	
Rated Temperature		160 °C			320 °F	





LINEAR 3

P/N	Inlet	Outlet	Weight		Icons	Checkmark
			gr	oz		
30.0620.00	3/8 Bsp F	1/4 Bsp F	596	21,02	20	✓
30.0620.50	3/8 Npt F	1/4 Npt F	596	21,02	20	✓
Rated Pressure	310 bar - 31 MPa		4500 psi			
Permissible Pressure	350 bar - 35 MPa		5000 psi			
Rated Flow	40 l/min		10,5 USGpm			
Rated Temperature	160 °C		320 °F			



LINEAR 3 + SW6

P/N	Inlet	Outlet	Weight		Icons	Checkmark
			gr	oz		
30.0640.00	+ sw.6 3/8 Bsp F	1/4 Bsp F	658	23,21	20	✓
Rated Pressure	310 bar - 31 MPa		4500 psi			
Permissible Pressure	350 bar - 35 MPa		5000 psi			
Rated Flow	40 l/min		10,5 USGpm			
Rated Temperature	160 °C		320 °F			



RL 37

P/N	Inlet	Outlet	Weight		Icons	Checkmark
			gr	oz		
30.1200.00	3/8 Bsp F	1/4 Bsp F	562	19,82	15	✓
30.1200.50	3/8 Npt F	1/4 Npt F	573	20,2	15	✓
30.1200.80	3/8 Bsp M	1/4 Bsp F	564	19,89	15	✓
Rated Pressure	310 bar - 31 MPa		4500 psi			
Permissible Pressure	350 bar - 35 MPa		5000 psi			
Rated Flow	40 l/min		10,5 USGpm			
Rated Temperature	160 °C		320 °F			



RL 37 + SW6/+ SW8

P/N	Inlet	Outlet	Weight		Icons	Checkmark
			gr	oz		
30.1220.00	+ sw.6 3/8 Bsp F	1/4 Bsp F	626	22,09	15	✓
30.1225.00	+ sw.8 3/8 Bsp M	1/4 Bsp F	648	22,86	15	✓
Rated Pressure	310 bar - 31 MPa		4500 psi			
Permissible Pressure	350 bar - 35 MPa		5000 psi			
Rated Flow	40 l/min		10,5 USGpm			
Rated Temperature	160 °C		320 °F			



RL 37 + SW8-35 SWIVELLING IN- AND OUTLET

P/N	Inlet	Outlet	Weight		15	✓
			gr	oz		
30.1247.00	+ sw.8 3/8 Bsp F	+sw.35 1/4 Bsp F	711	25,08	15	✓
Rated Pressure	310 bar - 31 MPa		4500 psi			
Permissible Pressure	350 bar - 35 MPa		5000 psi			
Rated Flow	40 l/min		10,5 USGpm			
Rated Temperature	160 °C		320 °F			



RL 30

P/N	Inlet	Outlet	Weight		20	✓
			gr	oz		
30.2500.00	3/8 Bsp F	1/4 Bsp F	614	21,65	20	✓
30.2500.30	3/8 Bsp M	1/4 Bsp F	620	21,9	20	✓
30.2500.20	A M22	1/4 Bsp F	622	21,94	20	✓
30.2500.25	A M22	A M22	629	22,19	20	✓
30.2500.28	3/8 Bsp F	A M22	740	26	20	✓
30.2500.50	3/8 Npt F	1/4 Npt F	614	21,65	20	✓
30.2515.00	3/8 Bsp F	1/4 Bsp F	740	26	20	
With ceramic ball - Suitable for chlore (30.2515.00)						
30.2515.50	3/8 Npt F	1/4 Npt F	613	21,62	20	
With ceramic ball - Suitable for chlore (30.2515.00-50)						
Rated Pressure	310 bar - 31 MPa		4500 psi			
Permissible Pressure	350 bar - 35 MPa		5000 psi			
Rated Flow	40 l/min		10,5 USGpm			
Rated Temperature	160 °C		320 °F			



RL 30 + SW6

P/N	Inlet	Outlet	Weight		20	✓
			gr	oz		
30.2511.00	+ sw.6 3/8 Bsp F	1/4 Bsp F	676	24,04	20	✓
30.2511.20	+sw.6 A M22	1/4 Bsp F	678	23,91	20	✓
Rated Pressure	310 bar - 31 MPa		4500 psi			
Permissible Pressure	350 bar - 35 MPa		5000 psi			
Rated Flow	40 l/min		10,5 USGpm			
Rated Temperature	160 °C		320 °F			





RL 31 - WITHOUT LABEL

P/N	Inlet	Outlet	Col.	Type	Weight		20
					gr	oz	
30.1900.00	3/8 Bsp F	1/4 Bsp F	Black	A	614	21,65	20
30.1900.30	3/8 Bsp M	1/4 Bsp F	Black	A	614	21,65	20
30.1920.00	+ sw.6 3/8 Bsp F	1/4 Bsp F	Black	A	676	24,04	20
30.1903.84R	-	--	RAL5002 Ultramarine Blue	B	6	0,2	100
30.1905.84R	-	--	RAL3013 Tomato Red	B	6	0,2	100
30.1907.84R	-	--	RAL6032 Signal Green	B	6	0,2	100
30.1909.84R	-	--	RAL2012 Salmon Orange	B	6	0,2	100
30.1911.84R	-	--	RAL1012 Lemon Yellow	B	6	0,2	100
Rated Pressure	310 bar - 31 MPa		4500 psi				
Permissible Pressure	350 bar - 35 MPa		5000 psi				
Rated Flow	40 l/min		10,5 USGpm				
Rated Temperature	160 °C		320 °F				



RL 31 - " PA "

P/N	Inlet	Outlet	Weight		20
			gr	oz	
30.1900.90	3/8 Bsp F	1/4 Bsp F	614	21,65	20
30.1920.90	+ sw.6 3/8 Bsp F	1/4 Bsp F	676	24,04	20
Rated Pressure	310 bar - 31 MPa		4500 psi		
Permissible Pressure	350 bar - 35 MPa		5000 psi		
Rated Flow	40 l/min		10,5 USGpm		
Rated Temperature	160 °C		320 °F		



VEGA

P/N	Inlet	Outlet	Weight		20	✓
			gr	oz		
30.2000.00	3/8 Bsp F	1/4 Bsp F	666	23,49	20	✓
30.2000.80	3/8 Bsp M	1/4 Bsp F	669	23,6	20	✓
30.2000.50	3/8 Npt F	1/4 Npt F	664	23,42	50	✓
Rated Pressure	310 bar - 31 MPa		4500 psi			
Permissible Pressure	350 bar - 35 MPa		5000 psi			
Rated Flow	40 l/min		10,5 USGpm			
Rated Temperature	160 °C		320 °F			



VEGA + SW8

P/N	Inlet	Outlet	Weight			
			gr	oz		
30.2030.00	+ sw.8 3/8 Bsp F	1/4 Bsp F	750	26,5	20	✓
30.2030.50	+ sw.8 3/8 Npt F	1/4 Npt F	750	26,5	20	
30.2030.12	+ sw.8 3/8 Bsp F	1/4 Bsp F	750	26,5	20	✓
Sw8 sst pin						
30.2030.80	+ sw.8 3/8 Bsp M	1/4 Bsp F	747	26,35	20	✓
30.2030.85	+ sw.8 3/8 Bsp M	1/4 Bsp F	747	26,35	20	✓
Sw8 sst pin						
30.2035.00	+ sw.8 3/8 Bsp F	1/4 Bsp F	744	26,24	20	✓
Ceram.ball+sst.pin Sw8						
Rated Pressure	310 bar - 31 MPa		4500 psi			
Permissible Pressure	350 bar - 35 MPa		5000 psi			
Rated Flow	40 l/min		10,5 USGpm			
Rated Temperature	160 °C		320 °F			



VEGA INOX

P/N	Inlet	Outlet	Weight			
			gr	oz		
30.3150.00	3/8 Bsp F	1/4 Bsp F	599	21,13	2	✓
30.3150.50	3/8 Npt F	1/4 Npt F	598	21,09	2	✓
Rated Pressure	310 bar - 31 MPa		4500 psi			
Permissible Pressure	350 bar - 35 MPa		5000 psi			
Rated Flow	40 l/min		10,5 USGpm			
Rated Temperature	160 °C		320 °F			
Material	Stainless steel 303					



VEGA "EZ" GUN WITH LOWER TRIGGER RESISTANCE

P/N	Inlet	Outlet	Weight			
			gr	oz		
30.2200.00	3/8 Bsp F	1/4 Bsp F	666	23,49	20	
30.2200.50	3/8 Npt F	1/4 Npt F	666	23,49	20	
Rated Pressure	310 bar - 31 MPa		4500 psi			
Permissible Pressure	350 bar - 35 MPa		5000 psi			
Rated Flow	40 l/min		10,5 USGpm			
Rated Temperature	160 °C		320 °F			

Gun with lower trigger resistance



VEGA "EZ"+ SW8- GUN WITH LOWER TRIGGER RESISTANCE **NEW**

P/N	Inlet	Outlet	Weight			
			gr	oz		
30.2230.00	+ sw.8 3/8 Bsp F	1/4 Bsp F	750	26,5	20	
30.2230.50	+ sw.8 3/8 Npt F	1/4 Npt F	750	26,5	20	
Rated Pressure	310 bar - 31 MPa		4500 psi			
Permissible Pressure	350 bar - 35 MPa		5000 psi			
Rated Flow	40 l/min		10,5 USGpm			
Rated Temperature	160 °C		320 °F			

Gun with lower trigger resistance





"FACILE"" GUN WITH LOWER TRIGGER RESISTANCE- WITHOUT LABEL **NEW**

P/N	Inlet	Outlet	Weight		
			gr	oz	
30.2300.00	3/8 Bsp F	1/4 Bsp F	698	24,62	20
Rated Pressure	310 bar - 31 MPa		4500 psi		
Permissible Pressure	350 bar - 35 MPa		5000 psi		
Rated Flow	40 l/min		10,5 USGpm		
Rated Temperature	160 °C		320 °F		

Gun with minimum fatigue for trigger opening and holding



"FACILE"" GUN WITH LOWER TRIGGER RESISTANCE- " PA " **NEW**

P/N	Inlet	Outlet	Weight		
			gr	oz	
30.2300.90	3/8 Bsp F	1/4 Bsp F	698	24,62	20
30.2315.90	+ sw.8 3/8 Bsp F	1/4 Bsp F	782	27,58	20
Rated Pressure	310 bar - 31 MPa		4500 psi		
Permissible Pressure	350 bar - 35 MPa		5000 psi		
Rated Flow	40 l/min		10,5 USGpm		
Rated Temperature	160 °C		320 °F		

Gun with lower trigger resistance



VEGA - FOOT ON-OFF GUN-3/8X1/4 BSP FF

P/N	Inlet	Outlet	Weight		
			gr	oz	
30.2160.00	3/8 Bsp F	1/4 Bsp F	5362	190	1 ✓
Rated Pressure	310 bar - 31 MPa		4500 psi		
Permissible Pressure	350 bar - 35 MPa		5000 psi		
Rated Flow	40 l/min		10,5 USGpm		
Max. Temper.	90 °C		195 °F		

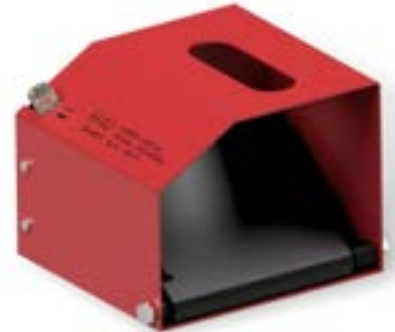

RL 56

P/N	Inlet	Outlet	Weight		8	✓
			gr	oz		
30.4500.10	3/8 Bsp F	1/4 Bsp F	672	23,7	8	✓
30.4500.60	3/8 Npt F	1/4 Npt F	672	23,7	8	✓
30.4520.10	+ sw. 3/8 Bsp F	1/4 Bsp F	762	26,87	8	✓

Rated Pressure	350 bar - 35 MPa	5100 psi
Permissible Pressure	390 bar - 39 MPa	5650 psi
Rated Flow	30 l/min	8 USGpm
Rated Temperature	160 °C	320 °F

With a new, improved mechanical device with double connecting rod



NOVA 400 INOX STAINLESS STEEL

P/N	Inlet	Outlet	Weight		2	✓
			gr	oz		
30.5650.00	3/8 Bsp F	1/4 Bsp F	601	21,2	2	✓
30.5650.50	3/8 Npt F	1/4 Npt F	601	21,2	2	✓
30.5665.00	+ sw.25 3/8 Bsp F	1/4 Bsp F	710	25	2	

Rated Pressure	400 bar - 40 MPa	5800 psi
Permissible Pressure	440 bar - 44 MPa	6400 psi
Rated Flow	40 l/min	10,5 USGpm
Rated Temperature	160 °C	320 °F
Material	Stainless steel 303	





RL57 SST GUN

P/N	Inlet	Outlet	Weight		✂	🚚
			gr	oz		
30.4700.00	3/8 Bsp F	1/4 Bsp F	714	25,18	1	✓
30.4700.50	3/8 Npt F	1/4 Npt F	716	25,25	1	✓
30.4720.00	+ sw.25 3/8 Bsp F	1/4 Bsp F	817	28,81	1	✓

Rated Pressure	500 bar - 50 MPa	7250 psi
Permissible Pressure	560 bar - 56 MPa	8100 psi
Rated Flow	28 l/min	7,5 USGpm
Rated Temperature	160 °C	320 °F
Material	Stainless steel 303	



RP 80/500- PNEUMATIC ON-OFF GUN

P/N	Max. flow rate		Inlet	Outlet	Weight		✂	🚚
	l/min	USGpm			gr	oz		
30.3250.00	80	21	1/2 Bsp F	1/2 Bsp F	2657	93,71	1	✓

Rated Pressure	500 bar - 50 MPa	7250 psi
Permissible Pressure	560 bar - 56 MPa	8100 psi
Rated Temperature	90 °C	195 °F
Required air pressure	7 bar - 0,7 MPa	101 psi
Compressed air fitting		1/4 Bsp F



RF 80/500- SST FOOT ON-OFF GUN

P/N	Max. flow rate		Inlet	Outlet	Weight		✂	🚚
	l/min	USGpm			gr	oz		
30.5450.00	80	21	1/2 Bsp F	1/2 Bsp F	7593	267,81	1	
30.5450.50	80	21	1/2 Npt F	1/2 Npt F	7593	267,81	1	

Rated Pressure	500 bar - 50 MPa	7250 psi
Permissible Pressure	560 bar - 56 MPa	8100 psi
Rated Temperature	90 °C	195 °F



RL500 SPRAY GUN 56MPa **NEW**

P/N	Inlet	Outlet	Weight		✓
			gr	oz	
30.5530.00	3/8 Bsp F	3/8 Bsp F	1223	41,6	1 ✓
Rated Pressure	500 bar - 50 MPa		7250 psi		
Permissible Pressure	560 bar - 56 MPa		8100 psi		
Rated Flow	40 l/min		10,5 USGpm		
Rated Temperature	160 °C		320 °F		
Shoulder rest			30.5060.00		



RL 84

P/N	Inlet	Outlet	Weight		✓
			gr	oz	
30.5400.001	1/2 Bsp F	1/2 Bsp F	1394	49,17	6
30.5400.00	1/2 Bsp F	1/2 Bsp F	1394	49,17	1 ✓
Rated Pressure	500 bar - 50 MPa		7250 psi		
Permissible Pressure	560 bar - 56 MPa		8100 psi		
Rated Flow	80 l/min		21 USGpm		
Rated Temperature	100 °C		210 °F		
Extensions			30.5000.40-80-92		



LANCE AND NOZZLE HOLDER FOR RL 84 - RL204 **NEW**

P/N	Length		Inlet	Outlet	Type	Weight		✓	
	mm	in.				gr	oz		
30.5000.40	400	15,7	1/2 Bsp M	1/4 Npt F	A	830	29,27	1 ✓	
30.5000.80	800	31,5	1/2 Bsp M	1/4 Npt F	A	1427	50,33	1 ✓	
30.5000.92	1250	50	1/2 Bsp M	1/4 Npt F	A	2036	71,81	1 ✓	
30.5030.80	800	31,5	1/2 Bsp M	1/4 Bsp M	B	1427	50,33	1 ✓	
30.5018.51R			Nipple 1/2 Bsp M	1/4 Npt F	C	55	2	1 ✓	
Nozzle holder									
Rated Pressure	500 bar - 50 MPa		7250 psi						
Permissible Pressure	560 bar - 56 MPa		8100 psi						
Rated Flow	200 l/min		53 USGpm						
Rated Temperature	43 °C		109 °F						
Material			Stainless steel						





RL600 SST GUN

P/N	Inlet	Outlet	Weight			
			gr	oz		
30.5800.00	3/8 Bsp F	3/8 Bsp F	991	34,95	1	✓
30.5820.00	3/8 Bsp F	3/8 Bsp F	1039	36,65	1	

Magnetic reed switch I= 0,5 A - V=48V AC/DC - P = 10 VA - 2 m cable

Rated Pressure	600 bar - 60 MPa	8700 psi
Permissible Pressure	660 bar - 66 MPa	9500 psi
Rated Flow	60 l/min	15,8 USGpm
Rated Temperature	100 °C	210 °F
Degree of Protection		IPX3
Protection Class		III
Shoulder rest		30.5060.00

Inlet swivel, n° 30.5840.00



SHOULDER REST

P/N	Length		Couplings	Weight			
	mm	in.		gr	oz		
30.5019.21	300	11,8	M18 × 1,5 mm M	310	10,9	1	
Suitable for RL80							
30.5060.00	300	11,8	1/4 Bsp M	219	7,72	5	✓
Suitable for RL600 - RL124 - RL204 - RL84							





RL1000 SST GUN

P/N	Inlet	Outlet	Weight			
			gr	oz		
30.5900.00	3/8 Bsp F	3/8 Bsp F	1173	41,38	1	✓
30.5900.30	M24 x 1.5 DKO	9/16"-18 Unf	1180	41,63	1	
30.5900.50	3/8 Npt F	3/8 Npt F	1173	41,38	1	
30.5900.60	3/8 Npt F	9/16"-18 Unf	1180	41,63	1	

Rated Pressure	1000 bar - 100 MPa	14500 psi
Permissible Pressure	1100 bar - 110 MPa	16000 psi
Rated Flow	40 l/min	10,5 USGpm
Rated Temperature	100 °C	210 °F





RLW 40 DUMP GUN

P/N	Length		Inlet	Outlet	Weight			
	mm	in.			gr	oz		
30.3000.50	400	15,74	3/8 Npt F	1/8 Npt F	948	33,44	20	
30.3100.50	1000	39,4	3/8 Npt F	1/8 Npt F	1362	48,04	10	✓
Rated Pressure	190 bar - 19 MPa				2750 psi			
Permissible Pressure	210 bar - 21 MPa				3050 psi			
Rated Flow	40 l/min				10,5 USGpm			
Rated Temperature	60 °C				140 °F			

High/low pressure gun with coaxial dual barrel





RL 35 SL - SPRAY GUN WITHOUT TRIGGER

P/N	Inlet	Outlet	Weight				
			gr	oz			
30.2100.00	3/8 Bsp F	1/4 Bsp F	372	13,12	15	✓	
30.2120.00	+ sw.8 3/8 Bsp F	1/4 Bsp F	357	12,6	15	✓	
Rated Pressure	220 bar - 22 MPa				3200 psi		
Permissible Pressure	250 bar - 25 MPa				3650 psi		
Rated Flow	35 l/min				9,2 USGpm		
Rated Temperature	160 °C				320 °F		





RL26 - WEEP GUN - BLUE SAFETY LATCH

P/N	Inlet	Outlet	Weep. flow rate		Weight			
			l/min	USGpm	gr	oz		
30.1790.00	3/8 Bsp M	1/4 Bsp F	1,1	0,30	396	13,97	20	✓
30.1790.50	1/4 Npt F	3/8 Npt F	1,1	0,3	400	14,11	20	✓
30.1792.00	+ sw.8 3/8 Bsp F	1/4 Bsp F	1,1	0,30	488	17,21	20	✓
30.1795.00	3/8 Bsp M	1/4 Bsp F	0,6	0,16	380	13,3	20	
30.1794.00	+ sw.8 3/8 Bsp F	1/4 Bsp F	0,6	0,16	485	17,11	20	✓
Rated Pressure	250 bar - 25 MPa				3650 psi			
Permissible Pressure	280 bar - 28 MPa				4050 psi			
Rated Flow	30 l/min				8 USGpm			
Rated Temperature	160 °C				320 °F			





VEGA - WEEP GUN - BLUE SAFETY LATCH

P/N	Inlet	Outlet	Weight				
			gr	oz			
30.2055.00	3/8 Bsp F	1/4 Bsp F	664	23,42	20	✓	
30.2055.50	3/8 Npt F	1/4 Npt F	668	23,56	20	✓	
30.2064.00	+ sw.8 3/8 Bsp F	1/4 Bsp F	750	26,5	20	✓	
Rated Pressure	310 bar - 31 MPa				4500 psi		
Permissible Pressure	350 bar - 35 MPa				5100 psi		
Rated Flow	40 l/min				10,5 USGpm		
Rated Temperature	160 °C				320 °F		







RL26 +SW6 - LOW PRESS.WEEP GUN - SAFETY LATCH, GREEN

P/N	Inlet	Outlet	Weight			
			gr	oz		
30.1780.00	3/8 Bsp F	1/4 Bsp F	400	14,11	20	✓
30.1782.00	+ sw.6 3/8 Bsp F	1/4 Bsp F	478	16,86	20	✓
Rated Pressure	250 bar - 25 MPa		3650 psi			
Permissible Pressure	280 bar - 28 MPa		4050 psi			
Rated Flow	30 l/min		8 USGpm			
Rated Temperature	160 °C		320 °F			

Not weeping at high pressure





RL37 + SW8-35 - LOW PRESS.WEEP GUN - SAFETY LATCH, GREEN

P/N	Inlet	Outlet	Weight			
			gr	oz		
30.1249.00	+ sw.8 3/8 Bsp F	+sw.35 1/4 Bsp F	711	25,08	15	✓
Rated Pressure	310 bar - 31 MPa		4500 psi			
Permissible Pressure	350 bar - 35 MPa		5000 psi			
Rated Flow	40 l/min		10,5 USGpm			
Rated Temperature	160 °C		320 °F			

Not weeping at high pressure



RL30 + SW6 - LOW PRESS.WEEP GUN - SAFETY LATCH, GREEN

P/N	Inlet	Outlet	Weight			
			gr	oz		
30.2580.05	3/8 Bsp F	1/4 Bsp F	614	21,66	20	✓
30.2625.05	+ sw.6 3/8 Bsp F	1/4 Bsp F	677	23,88	20	✓
Rated Pressure	310 bar - 31 MPa		4500 psi			
Permissible Pressure	350 bar - 35 MPa		5000 psi			
Rated Flow	40 l/min		10,5 USGpm			
Rated Temperature	160 °C		320 °F			

Not weeping at high pressure



RL 34 + SW GUN +ARS- B- BALL QUICK COUPLING

P/N	Inlet	Outlet	Weight		2
			gr	oz	
30.2940.00 Inlet with swivel	+ sw. 1/2 Bsp F	ARS350 B	726	25,2	2
30.2960.00 Inlet with swivel	+ sw. 1/2 Bsp F	ARS 178 B	710	25,04	2 ✓
30.2980.00 Inlet with swivel	+ sw. 1/2 Bsp F	ARS 25 B	790	27,86	2
Rated Pressure	125 bar - 12,5 MPa		1850 psi		
Permissible Pressure	140 bar - 14 MPa		2000 psi		
Rated Flow		80 l/min	21 USGpm		
Rated Temperature		160 °C	320 °F		
Material			Brass		



RL 82 +SW GUN +ARS- B- BALL QUICK COUPLING

P/N	Inlet	Outlet	Weight		2
			gr	oz	
30.2840.00 Inlet with swivel	+ sw. 1/2 Bsp F	ARS350 B	704	24,83	2
30.2860.00 Inlet with swivel	+ sw. 1/2 Bsp F	ARS 178 B	697	24,58	2 ✓
30.2880.00 Inlet with swivel	+ sw. 1/2 Bsp F	ARS 25 B	774	27,3	2
Rated Pressure	125 bar - 12,5 MPa		1850 psi		
Permissible Pressure	140 bar - 14 MPa		2000 psi		
Rated Flow		80 l/min	21 USGpm		
Rated Temperature		160 °C	320 °F		
Material			Stainless steel		



RL 16 + PL4+ M27 M

P/N	Inlet	Outlet	Hand Grip	Weight		20
				gr	oz	
30.0450.00	1/4 Bsp F	M 27 M	PL 4	588	20,74	20
Rated Pressure	160 bar - 16 MPa			2350 psi		
Permissible Pressure	175 bar - 17,5 MPa			2550 psi		
Rated Flow		30 l/min		8 USGpm		
Rated Temperature		60 °C		140 °F		



RL 160 + S4/R5 + M22



P/N	Inlet	Outlet	Hand Grip	Weight		25
				gr	oz	
30.0050.40	1/4 Bsp M	AR1 B M22	S4	581	20,49	25
30.0050.20	1/4 Bsp F	AR1 B M22	S4	586	20,67	25
30.0050.00	3/8 Bsp F	AR1 B M22	S4	592	20,88	25 ✓
Rated Pressure	160 bar - 16 MPa			2300 psi		
Permissible Pressure	175 bar - 17,5 MPa			2550 psi		
Rated Flow		30 l/min		8 USGpm		
Rated Temperature		100 °C		210 °F		







Spray guns with lance hand grip/quick coupling

RL 11 + S1+ AR6 M22

P/N	Inlet	Outlet	Hand Grip	Weight		20		
				gr	oz			
30.0940.00	3/8 Bsp F	AR1 B M22	S1	788	27,79	20		
30.0940.40	1/4 Bsp M	AR1 B M22	S1	778	27,44	20		
Rated Pressure	160 bar - 16 MPa			2300 psi				
Permissible Pressure	175 bar - 17,5 MPa			2550 psi				
Rated Flow	30 l/min			8 USGpm				
Rated Temperature	100 °C			210 °F				





RL 200 + S4 + M22

P/N	Inlet	Outlet	Weight		25			
			gr	oz				
30.0150.30	1/4 Bsp M	AR1 B M22	550	19,2	25			
30.0150.60	3/8 Bsp M	AR1 B M22	594	20,95	25	✓		
30.0150.00	3/8 Bsp F	AR1 B M22	598	21,09	25	✓		
30.0150.40	A M22	AR1 B M22	609	21,48	25			
Rated Pressure	200 bar - 20 MPa			2900 psi				
Permissible Pressure	220 bar - 22 MPa			3200 psi				
Rated Flow	30 l/min			8 USGpm				
Rated Temperature	160 °C			320 °F				





RL 36 + S3 + M22

P/N	Inlet	Outlet	Weight		15		
			gr	oz			
30.1600.00	3/8 Bsp M	AR5/4 B M22	946	33,36	25		
30.1611.00	+ sw.8 3/8 Bsp F	AR5/4 B M22	1052	37,1	15		

Technical Data: RL36



RL 26 + S4 + M22

P/N	Inlet	Outlet	Hand Grip	Weight		20		
				gr	oz			
30.0761.00	3/8 Bsp M	AR1 B M22	S4	730	25,7	20		
30.0760.00	A M22	AR1 B M22	S4	746	26,31	20		
30.0755.00	3/8 Bsp M	AR4 B M22	S4	738	26,03	20	✓	
30.0759.00	+ sw.6 3/8 Bsp F	AR4 B M22	S4	807	28,46	20		
30.0781.00	3/8 Bsp M	AR5/4 B M22	S3	744	26,24	20		

Technical Data: RL26



RL 26 + PL4 + AR4 B M22

P/N	Inlet	Outlet	Weight		20
			gr	oz	
30.0740.00	3/8 Bsp M	AR4 B M22	706	25,1	

Technical Data : RL26



RL 37 + S7 + AR6 M22

P/N	Inlet	Outlet	Weight		15
			gr	oz	
30.1280.00	3/8 Bsp F	AR6 B M22	886	31,25	
30.1280.80	3/8 Bsp M	AR6 B M22	913	32,17	
30.1281.00	+ sw.6 3/8 Bsp F	AR6 B M22	946	33,37	✓
30.1291.00	+ sw.8 3/8 Bsp M	AR6 B M22	913	32,17	✓

Rated Pressure 280 bar - 28 MPa 4050 psi
 Permissible Pressure 310 bar - 31 MPa 4500 psi
 Rated Flow 40 l/min 10,5 USGpm
 Rated Temperature 160 °C 320 °F

Technical Data : RL37



RL 37 + R5-1000MM+ ARSU

P/N	Inlet	Hose length		Outlet	Weight		15
		m	yd		gr	oz	
30.1292.50	3/8 Npt F	1000	39,4	Arsu	1,242	43,81	

Rated Pressure 280 bar - 28 MPa 4050 psi
 Permissible Pressure 310 bar - 31 MPa 4500 psi
 Rated Flow 40 l/min 10,5 USGpm
 Rated Temperature 160 °C 320 °F

Technical Data : RL37



RL 300 - S3 370 MM + AR1/4 B M22

P/N	Tube type	Inlet	Outlet	Weight		15
				gr	oz	
30.2608.11	Z.pl.steel	3/8 Bsp M	AR1/4 B M22	948	33,44	✓
30.2608.30	Z.pl.steel	A M22	AR1/4 B M22	948	33,44	✓
30.2616.00	Stainl. steel	+ sw.6 3/8 Bsp F	AR1/4 B M22	982	34,64	

Technical Data : RL30





Spray guns with lance hand grip/quick coupling

RL 300 - S3 370 MM + AR5/4 B M22

P/N	Tube type	Inlet	Weight		15	✓
			gr	oz		
30.2600.11	Z.pl.steel	3/8 Bsp M	968	34,14	15	✓
30.2601.11	Z.pl.steel	3/8 Bsp F	964	34	15	✓
30.2607.11	Stainl. steel	+ sw.6 3/8 Bsp F	994	35,34	25	✓

Outlet AR5/4 B M22

Technical Data : RL30



RL 310 - S2 370 MM + AR5/4 B M22- WITHOUT LABEL **NEW**

P/N	Tube type	Inlet	Type	Col.	Weight		25	✓
					gr	oz		
30.1960.00	Stainl. steel	+ sw.6 3/8 Bsp F	A	Black	994	35,34	25	✓
30.1903.84R	-	-	RAL5002 Ultramarine Blue	B	6	0,2	100	
30.1905.84R	-	-	RAL3013 Tomato Red	B	6	0,2	100	
30.1907.84R	-	-	RAL6032 Signal Green	B	6	0,2	100	
30.1909.84R	-	-	RAL2012 Salmon Orange	B	6	0,2	100	
30.1911.84R	-	-	RAL1012 Lemon Yellow	B	6	0,2	100	

Outlet AR5/4 B M22

Technical Data : RL31

<https://www.pa-etl.it/flex/FixedPages/Common/catalogo.php/L/EN/prodotto/rl-31-senza-bottone?uniq=17a77d64ad0c23a877e3d13febb1ae111>



VEGA + RF1 + R5-300MM + AR5 B M22

P/N	Inlet	Outlet	Weight		10
			gr	oz	
30.2070.00	3/8 Bsp F	AR5/4 B M22	1196	42,2	10

Lance with flow regulator - Technical Data: Vega



VEGA/RL30 + S3 370MM + AR5 B M22

P/N	Tube type	Inlet	Gun type	Weight		15	✓
				gr	oz		
30.2091.00	Stainl. steel	3/8 Bsp F	Vega	1030	36,33	15	
30.2097.00	Z.pl.steel	3/8 Bsp F	Vega	1050	37,03	25	✓
30.2098.00	Z.pl.steel	3/8 Bsp M	Vega	1069	38	25	✓
30.2083.00	Stainl. steel	+ sw.8 3/8 Bsp M	Vega	1112	39,22	25	✓
30.3091.60	Stainl. steel	A M22	RL 30	984	34,71	25	

Outlet AR5/4 B M22

Technical Data : Vega



RL 51 GUN + ARS 23 - B BALL QUICK COUPLING

P/N	Inlet	Outlet	Weight		10		
			gr	oz			
30.4140.23	+ sw. 3/8 Bsp F	ARS 23 B	1000	35,27	10		
Rated Pressure	250 bar - 25 MPa		3650 psi				
Permissible Pressure	280 bar - 28 MPa		4050 psi				
Rated Flow	40 l/min		10,5 USGpm				
Rated Temperature	160 °C		320 °F				



RL 30 GUN + ARS 23 - B BALL QUICK COUPLING

P/N	Inlet	Outlet	Weight		4		
			gr	oz			
30.2540.30	3/8 Bsp F	ARS 23 B	880	31,1	4		
Rated Pressure	310 bar - 31 MPa		4500 psi				
Permissible Pressure	350 bar - 35 MPa		5000 psi				
Rated Flow	40 l/min		10,5 USGpm				
Rated Temperature	160 °C		320 °F				



SPRAY GUNS + ARS350 - B BALL QUICK COUPLING SST

P/N	Gun type	Inlet	Outlet	Weight		8		
				gr	oz			
30.2540.00	RL 30	A M22	ARS350 B	760	26,8	8		
30.2040.00	Vega	+ sw.8 3/8 Bsp F	ARS350 B	887	31,29	8		
With ceramic ball - Suitable for chlore - Sw8 with sst. pin. (30.2040.00)								
Rated Pressure	310 bar - 31 MPa		4500 psi					
Permissible Pressure	350 bar - 35 MPa		5000 psi					
Rated Flow	40 l/min		10,5 USGpm					
Rated Temperature	160 °C		320 °F					



RL 36 GUN +ARS25- B-KW BALL QUICK COUPLING

P/N	Inlet	Outlet	Mat.	Type	Weight		2		
					gr	oz			
30.1535.00	A M22	ARS 25 B	St. steel	Y	900	32	2		
30.1538.00	+sw.6 A M22	ARS 25 B	St. steel	Y	900	32	2		
Rated Pressure	280 bar - 28 MPa		4000 psi						
Permissible Pressure	310 bar - 31 MPa		4500 psi						
Rated Flow	30 l/min		8 USGpm						
Rated Temperature	160 °C		320 °F						
Material			Brass						





RL 30 GUN +ARS25- B-KW BALL QUICK COUPLING

P/N	Inlet	Outlet	Mat.	Type	Weight		Box	Tray
					gr	oz		
30.2540.60	3/8 Bsp F	ARS 25 B	Brass	X	900	32	4	✓
30.2619.00	A M22	ARS 25 B	Brass	Y	830	29,27	15	
Rated Pressure	310 bar - 31 MPa				4500 psi			
Permissible Pressure	350 bar - 35 MPa				5000 psi			
Rated Flow	40 l/min				10,5 USGpm			
Rated Temperature	160 °C				320 °F			



SST VEGA GUN +ARS25- B-KW BALL QUICK COUPLING

P/N	Inlet	Outlet	Mat.	Weight		Box	Tray	
				gr	oz			
30.3140.60	3/8 Bsp F	ARS 25 B	St. steel	805	28,39	1		
Rated Pressure	310 bar - 31 MPa				4500 psi			
Permissible Pressure	350 bar - 35 MPa				5000 psi			
Rated Flow	40 l/min				10,5 USGpm			
Rated Temperature	160 °C				320 °F			
Material					Stainless steel 303			



RL 56 + SW + AR8 + S3 350 LANCE

P/N	Length		Inlet	Outlet	Weight		Box	Tray
	mm	in.			gr	oz		
30.4520.15	-	-	+ sw. 3/8 Bsp F	AR 8 B M24	816	28,78	8	✓
40.0262.00	1050	41,3	AR8 "A"	1/4 Npt F	898	31,67	8	✓
40.0262.50	1050	41,3	AR8 "A"	1/8 Npt F	897	31,64	8	
Rated Pressure	350 bar - 35 MPa				5100 psi			
Permissible Pressure	390 bar - 39 MPa				5650 psi			
Rated Flow	30 l/min				8 USGpm			
Rated Temperature	160 °C				320 °F			



RL600SST. AI303 - LANCE 140 MM +AR9 'B' -M24

P/N	Inlet	Outlet	Length		Weight		Box	Tray
			mm	in.	gr	oz		
30.5830.00	3/8 Bsp F	AR9 'B' -M24	140	5,50	1282	45,22	1	
Rated Pressure	600 bar - 60 MPa				8700 psi			
Permissible Pressure	660 bar - 66 MPa				9500 psi			
Rated Flow	60 l/min				15,8 USGpm			
Rated Temperature	100 °C				210 °F			
Material					Stainless steel 303			
Shoulder rest					30.5060.00			



GUN RL11 WITH LANCE- S1- 700MM+ PROTECTION+NOZZLE HOLDER

P/N	Inlet	Length		Hand Grip	Outlet	Weight		
		mm	in.			gr	oz	
30.0970.00	3/8 Bsp F	700	27,5	S1	1/4 Npt F	916	32,31	20
Rated Pressure	160 bar - 16 MPa				2300 psi			
Permissible Pressure	175 bar - 17,5 MPa				2550 psi			
Rated Flow	30 l/min				8 USGpm			
Rated Temperature	100 °C				210 °F			



GV 5 -VARIABLE ANGLE JET LANCE + SP.GUN

P/N	Inlet	Nozzle Size	Nozzle	Gun type	Weight			
					mm	gr		oz
30.0885.10	3/8 Bsp F	03	1,0	RL 11	2000	69,8	5	
30.1587.20	+ sw. 3/8 Bsp F	12	2,0	RL 36	2219,5	78,3	5	
Swivel with sst. pin								
30.1585.20	3/8 Bsp F	12	2,0	RL 36	2129,2	74,3	5	
30.4145.30	3/8 Bsp F	25	3,0	RL 51	2249,2	79	5	
Rated Pressure	280 bar - 28 MPa				4050 psi			
Permissible Pressure	310 bar - 31 MPa				4500 psi			
Rated Temperature	90 °C				195 °F			
Tube type					Stainl. steel			



WARNING: Use only "PA" nozzles (M16x2).

GV 10 -VARIABLE ANGLE JET LANCE + RL34+SW. SP.GUN

P/N	Nozzle Size	Nozzle	Weight			
			mm	gr		oz
30.2930.35	35	3,7	2658,2	93,77	5	
Rated Pressure	180 bar - 18 MPa				2600 psi	
Permissible Pressure	200 bar - 20 MPa				2900 psi	
Rated Temperature	43 °C				110 °F	
Tube type					Stainl. steel	
Inlet					+ sw. 1/2 Bsp F	



WARNING: Use only "PA" nozzles (M16).

GV 10 -VARIABLE ANGLE JET LANCE + RL124 SP.GUN

P/N	Nozzle Size	Nozzle	Weight			
			mm	gr		oz
30.5382.50	50	4,4	2966	104,62	5	
Rated Pressure	120 bar - 12 MPa				1750 psi	
Permissible Pressure	135 bar - 13,5 MPa				1950 psi	
Rated Temperature	43 °C				110 °F	
Tube type					Stainl. steel	
Inlet					1/2 Bsp F	



WARNING: Use only "PA" nozzles (M16).



GV 10 + RB65 SPRAY GUN

P/N	Length		Inlet	Nozzle	Gun type	Weight		5	✓
	mm	in.				gr	oz		
30.6485.90	843	33,19	1/2 Bsp F	7,0	RB65 100l/min	2800	98,77		
Permissible Pressure	24 bar - 2,4 MPa				350 psi				
Max. flow rate	100 l/min				26,5 USGpm				
Rated Temperature	60 °C				140 °F				

WARNING: Use only "PA" nozzles (M16).



GV 10+ LS9 -VARIABLE ANGLE JET FOAM LANCE + RL51 **NEW**

P/N	Nozzle	Weight		5	✓
		mm	gr		
30.4200.00	8	2690	94,9		
Rated Pressure	150 bar - 15 MPa		2175 psi		
Permissible Pressure	165 bar - 16,5 MPa		2400 psi		
Max. Temper.	90 °C		195 °F		
Tube type			Stainl. steel		
Inlet			3/8 Bsp F		

WARNING: Use only "PA" nozzles (M16).



RL300 +SW8 3/8BSP +LS12 - FOAM LANCE +AD+PROTEC.

P/N	Max. flow rate		Nozzle	Col.	Outlet	Weight		2	
	l/min	USGpm				mm	gr		oz
30.2710.18	10	2,6	1,8	Black	1/4 Npt F	1456	51,35		
With ceramic ball-Sw8 pin sst.									
30.2710.21	15	4	2,1	Red	1/4 Npt F	1456	51,35		
With ceramic ball-Sw8 pin sst.									
Rated Pressure	200 bar - 20 MPa				2900 psi				
Permissible Pressure	220 bar - 22 MPa				3200 psi				
Rated Flow	25 l/min				6,5 USGpm				
Rated Temperature	38 °C				100 °F				
Inlet					+ sw.8 3/8 Bsp M				
Injector					21.0600.12-14				

Injector 21.0600.12 is compulsory for foam lance LS12 30.2710.18
 Injector 21.0600.14 is compulsory for foam lance LS12 30.2710.21



RL26 GUN 1/4F BSP+CERAM.BALL+700MM SST LANCE

P/N	Inlet	Outlet	Weight		10
			gr	oz	
30.1757.00	1/4 Bsp F	1/4 Npt F	772	27,23	
Rated Pressure	250 bar - 25 MPa		3650 psi		
Rated Flow	30 l/min		8 USGpm		
Rated Temperature	160 °C		320 °F		
Length	700 mm		27,5 in.		
Tube type			1/4 Sst.		
Gun type			RL 26 1/4Bsp F+ceram.ball		

Wear to chemical detergent



GUN RL26+SW8 WITH LANCE- EVER WEeping

P/N	Inlet	Length		Weep. flow rate		Weight			
		mm	in.	l/min	USGpm	gr	oz		
30.0767.00	+ sw.8 3/8 Bsp F	700	27,5	1,1	0,30	962	33,93	10	✓
30.0767.06	+ sw.8 3/8 Bsp F	700	27,5	0,6	0,16	966	34,07	10	✓
30.0768.00	+ sw.8 3/8 Bsp F	900	35,4	1,1	0,30	1058	37,32	10	
30.0768.06	+ sw.8 3/8 Bsp F	900	35,4	0,6	0,16	1058	37,32	10	

Rated Pressure	250 bar - 25 MPa	3650 psi
Permissible Pressure	280 bar - 28 MPa	4050 psi
Rated Flow	30 l/min	8 USGpm
Rated Temperature	160 °C	320 °F
Outlet		1/4 Npt F



RL26 + SW6 LOW PRESSURE WEEP GUN +R5-700 SST LANCE

P/N	Inlet	Length		Outlet	Weight			
		mm	in.		gr	oz		
30.1796.00	+ sw.6 3/8 Bsp F	700	27.5	1/4 Npt F	958	33,79	10	✓

Rated Pressure	250 bar - 25 MPa	3650 psi
Permissible Pressure	280 bar - 28 MPa	4050 psi
Rated Flow	30 l/min	8 USGpm
Rated Temperature	160 °C	320 °F

Not weeping at high pressure



RL37 + SW8-35 - LOW PRESSURE WEEP GUN +R5 SST LANCE

P/N	Inlet	Length		Outlet	Weight			
		mm	in.		gr	oz		
30.1307.10	+ sw.8 3/8 Bsp F	700	27.5	1/4 Bsp M	1165	41,09	10	✓



Rated Pressure	280 bar - 28 MPa	4050 psi
Permissible Pressure	310 bar - 31 MPa	4500 psi
Rated Flow	40 l/min	10,5 USGpm
Rated Temperature	160 °C	320 °F

Not weeping at high pressure





RL300 +SW8 3/8BSP -R5 +LD12 - FOAM LANCE +AD+PROTEC.



P/N	Max. flow rate		Nozzle	Col.	Outlet	Weight		 	
	l/min	USGpm				mm	gr		oz
30.2700.18	10	2,6	1,8	Black	1/4 Npt F	1684	59,4	2	
With ceramic ball + Sw8 pin sst.									
30.2700.21	15	4	2,1	Red	1/4 Npt F	1687	59,5	2	
With ceramic ball.Sw8 pin sst.									

Rated Pressure	200 bar - 20 MPa	2900 psi
Permissible Pressure	220 bar - 22 MPa	3200 psi
Rated Flow	25 l/min	6,5 USGpm
Rated Temperature	60 °C	140 °F
Inlet		+ sw.8 3/8 Bsp M
Injector		21.0600.12-14

Injector 21.0600.12 is compulsory for foam lance LS12 30.2700.18
 Injector 21.0600.14 is compulsory for foam lance LS12 30.2700.21





RL37 + SW8-35 +SST R5 +PROTECTION+NOZZLE HOLDER

P/N	Inlet	Length		Outlet	Weight		 
		mm	in.		gr	oz	
30.1262.10	+ sw.8 3/8 Bsp F	1200	47,2	1/4 Npt F	1394	49,17	10
Rated Pressure	280 bar - 28 MPa	4050 psi					
Permissible Pressure	310 bar - 31 MPa	4500 psi					
Rated Flow	40 l/min	10,5 USGpm					
Rated Temperature	160 °C	320 °F					





RL 30 - S3 500 MM -1/4 F NPT

P/N	Length		Tube type	Weight		 
	mm	in.		gr	oz	
30.2610.11	500	19,7	1/4 Sst.	1002	35,34	20 
Inlet						3/8 Bsp F
Outlet						1/4 Npt F

Technical Data : RL30



RL 56 + AL-F 39MPA LANCE

P/N	Length		Inlet	Outlet	Weight		 
	mm	in.			gr	oz	
30.4560.00	800	31,5	3/8 Bsp F	1/4 Npt F	1244	43,88	8
30.4561.00	1050	41,3	3/8 Bsp F	1/4 Npt F	1244	43,88	8
30.4562.00	1200	47,24	3/8 Bsp F	1/4 Npt F	1450	51,3	8
Rated Pressure	350 bar - 35 MPa	5100 psi					
Permissible Pressure	390 bar - 39 MPa	5650 psi					
Rated Flow	30 l/min	8 USGpm					
Rated Temperature	160 °C	320 °F					



RL 56 + S3 350 LANCE

P/N	Length		Inlet	Outlet	Weight			
	mm	in.			gr	oz		
30.4550.09	800	34	3/8 Bsp F	1/4 Npt F	1118	39,43	8	✓
30.4570.09	800	34	+ sw. 3/8 Bsp F	1/4 Npt F	1205	42,5	8	
30.4550.10	1050	41,3	3/8 Bsp F	1/4 Npt F	1350	47,62	8	
30.4550.60	1050	41,3	3/8 Npt F	1/4 Npt F	1356	47,83	8	✓
30.4550.12	1200	51	3/8 Bsp F	1/4 Npt F	1432	50,51	8	
30.4550.62	1200	51	3/8 Npt F	1/4 Npt F	1432	50,51	8	
30.4570.12	1200	51	+ sw. 3/8 Bsp F	1/4 Npt F	1486	52,41	8	✓

Rated Pressure	350 bar - 35 MPa	5100 psi
Permissible Pressure	390 bar - 39 MPa	5650 psi
Rated Flow	30 l/min	8 USGpm
Rated Temperature	160 °C	320 °F



RL 57 +AF-L 55MPA LANCE

P/N	Length		Inlet	Outlet	Weight			
	mm	in.			gr	oz		
30.4740.00	1050	41,3	3/8 Bsp F	1/4 Npt F	1592	56,15	2	✓
30.4742.00	1200	51	3/8 Bsp F	1/4 Npt F	1820	64,19	2	

Rated Pressure	500 bar - 50 MPa	7250 psi
Permissible Pressure	550 bar - 55 MPa	8000 psi
Rated Flow	28 l/min	7,5 USGpm
Rated Temperature	160 °C	320 °F
Material		Stainless steel 303



RL 57 +S3 50MPA LANCE

P/N	Length		Inlet	Outlet	Weight			
	mm	in.			gr	oz		
30.4730.00	1050	41,3	3/8 Bsp F	1/4 Npt F	1720	60,67	2	✓
30.4730.50	1050	41,3	3/8 Npt F	1/4 Npt F	1720	60,67	2	
30.4732.00	1200	51	3/8 Bsp F	1/4 Npt F	1820	64,19	2	✓
30.4732.50	1200	51	3/8 Npt F	1/4 Npt F	1820	64,19	2	

Rated Pressure	500 bar - 50 MPa	7250 psi
Permissible Pressure	550 bar - 55 MPa	8000 psi
Rated Flow	28 l/min	7,5 USGpm
Rated Temperature	160 °C	320 °F
Material		Stainless steel 303



RL500 GUN + S6 LANCE **NEW**

P/N	Inlet	Outlet	Length		Weight			
			mm	in.	gr	oz		
30.5580.00	3/8 Bsp F	1/4 Npt F	800	31,5	2128	75,06	1	✓

Rated Pressure	500 bar - 50 MPa	7250 psi
Permissible Pressure	560 bar - 56 MPa	8150 psi
Rated Flow	40 l/min	10,5 USGpm
Rated Temperature	160 °C	320 °F
Shoulder rest		30.5060.00





RL600 STAINLESS STEEL GUN + S6 LANCE

P/N	Inlet	Outlet	Length		Weight		1	✓
			mm	in.	gr	oz		
30.5880.00	3/8 Bsp F	1/4 Npt F	800	31,5	2128	75,06	1	✓
Rated Pressure	600 bar - 60 MPa				8700 psi			
Permissible Pressure	660 bar - 66 MPa				9500 psi			
Rated Flow	60 l/min				15,8 USGpm			
Rated Temperature	100 °C				210 °F			
Degree of Protection					IPX3			
Protection Class					III			
Shoulder rest					30.5060.00			





RL1000 STAINLESS STEEL GUN + LANCE 640 MM/ 1220 MM

P/N	Inlet	Outlet	Length		Weight		1	
			mm	in.	gr	oz		
30.5920.00	3/8 Bsp F	1/4 Npt F	640	25,2	10810	381,31	1	
30.5920.10	3/8 Bsp F	M 10	640	25,2	10810	381,31	1	
30.5920.20	3/8 Bsp F	1/8 Npt F	640	25,2	10810	381,31	1	
30.5920.50	3/8 Npt F	1/4 Npt F	1220	48,4	10325	364,2	1	
30.5920.60	M24 x 1.5 DKO	M 10	1220	48,4	10325	364,2	1	
30.5920.65	M24 x 1.5 DKO	1/4 Npt F	1220	48,4	10325	364,2	1	
30.5920.70	3/8 Npt F	1/8 Npt F	1220	48,4	10325	364,2	1	
Rated Pressure	1000 bar - 100 MPa				14500 psi			
Permissible Pressure	1100 bar - 110 MPa				16000 psi			
Rated Flow	40 l/min				10,5 USGpm			
Rated Temperature	100 °C				210 °F			





EXTENSION PL4 + SPECIAL NOZZLES+ M27 F

P/N	Length		Inlet	Outlet	Weight			
	mm	in.			gr	oz		
41.1199.12	260	10,2	M 27 F	HL250-03	409	14,43	25	
Rated Pressure	160 bar - 16 MPa				2350 psi			
Permissible Pressure	175 bar - 17,5 MPa				2550 psi			
Rated Flow			30 l/min		8 USGpm			
Rated Temperature			60 °C		140 °F			





EXTENSION AR1 A M22 + SPECIAL NOZZLES

P/N	Length		Outlet	Weight				
	mm	in.		gr	oz			
41.1007.13	300	11,8	HL250-035	355	12,5	20		
41.1002.00	500	19,7	TR1-1/4	423	14,92	50		
41.1027.00	700	27,5	TR1-1/4	525	18,5	30	✓	
Rated Pressure	250 bar - 25 MPa				3650 psi			
Permissible Pressure	280 bar - 28 MPa				4050 psi			
Rated Flow			40 l/min		10,5 USGpm			
Rated Temperature			90 °C		195 °F			
Inlet			AR1 A M22					





EXTENSION AR5 A M22 + SPECIAL NOZZLES

P/N	Length		Outlet	Weight				
	mm	in.		gr	oz			
41.1018.13	500	19,7	HL250-035	470	16,58	10		
41.1029.00	500	19,7	TR1-1/4	440	15,52	30		
Rated Pressure	250 bar - 25 MPa				3650 psi			
Permissible Pressure	280 bar - 28 MPa				4050 psi			
Rated Flow			40 l/min		10,5 USGpm			
Rated Temperature			90 °C		195 °F			
Inlet			AR5 A M22 2×O-rings					



EXTENSION PL4 + SPECIAL NOZZLES

P/N	Length		Inlet	Outlet	Weight			
	mm	in.			gr	oz		
41.2050.00	500	19,7	AR4 A M22 hex.	TR4- 1/4	693	24,44	30	
41.2068.13	500	19,7	AR4 A M22 hex.	HL250-035	612	21,59	30	
41.2066.13	500	19,7	AR5 A M22	HL250-035	594	20,95	30	
41.2051.00	500	19,7	AR5 A M22	TR1-1/4	514	18,13	30	
41.2053.00	500	19,7	AR5 A M22	TR4- 1/4	702	24,76	30	
41.1028.00	700	27,5	AR5 A M22	TR1-1/4	632	22,29	30	
Rated Pressure	250 bar - 25 MPa				3650 psi			
Permissible Pressure	280 bar - 28 MPa				4050 psi			
Rated Flow			40 l/min		10,5 USGpm			
Rated Temperature			90 °C		195 °F			





EXTENSION AR5 A M22 WITH NOZZLE HOLDER

P/N	Length		Tube type	Outlet	Weight		Icons	Checkmark
	mm	in.			gr	oz		
40.5146.00	500	19,7	Sst. - PL4	1/4 Npt F	406	14,32	30	
40.5173.00	700	27,5	Sst. - PL4	1/4 Npt F	546	19,26	30	✓
40.5173.50	700	27,5	Sst. - PL4	1/8 Npt F	546	19,26	30	
40.5190.00	900	35,4	Sst. - PL4	1/4 Npt F	637	22,47	30	✓
40.5150.00	500	19,7	Stainl. steel	1/4 Npt F	330	11,64	30	✓
40.5151.00	700	25,7	Stainl. steel	1/4 Npt F	404	14,25	30	
40.5145.00	500	19,7	Z.pl.steel	1/4 Npt F	368	12,98	30	✓
40.5152.00	700	25,7	Z.pl.steel	1/4 Npt F	472	16,65	30	✓

Rated Pressure 250 bar - 25 MPa 3650 psi
 Permissible Pressure 280 bar - 28 MPa 4050 psi
 Rated Flow 40 l/min 10,5 USGpm
 Rated Temperature 160 °C 320 °F
 Inlet AR5 A M22 2xO-rings

PL4 version with tube plastic protection



EXTENSION S7K- AR6 A M22 WITH NOZZLE HOLDER

P/N	Length		Tube type	Outlet	Weight		Icons	Checkmark
	mm	in.			gr	oz		
30.1255.00	500	19,7	Z.pl.steel -S7k	1/4 Npt F	401	14,14	25	
30.1258.00	700	27,5	Z.pl.steel -S7k	1/4 Npt F	507	17,88	25	

Rated Pressure 280 bar - 28 MPa 4050 psi
 Permissible Pressure 310 bar - 31 MPa 4500 psi
 Rated Flow 40 l/min 10,5 USGpm
 Rated Temperature 160 °C 320 °F
 Inlet AR6 A M22 1 OR

With quick coupling plastic protection



EXTENSION S7- AR6 A M22 WITH NOZZLE HOLDER

P/N	Length		Tube type	Outlet	Weight		Icons	Checkmark
	mm	in.			gr	oz		
30.1295.00	500	19,7	Z.pl.steel -S7	1/4 Npt F	474	16,7	25	
30.1297.00	700	27,5	Z.pl.steel -S7	1/4 Npt F	578	20,39	25	

Rated Pressure 280 bar - 28 MPa 4050 psi
 Permissible Pressure 310 bar - 31 MPa 4500 psi
 Rated Flow 40 l/min 10,5 USGpm
 Rated Temperature 160 °C 320 °F
 Inlet AR6 A M22 1 OR

With S7 plastic grip



90° UNDERBODY LANCE EXTENSION WITH NOZZLE HOLDER

P/N	Length		Inlet	Outlet	Weight		Icons	Checkmark
	mm	in.			gr	oz		
40.0058.00	700	27,5	AR1 A M22	1/4 Npt F	454	16,01	10	✓
40.5176.50	700	27,5	AR5 A M22	1/8 Npt F	564	19,9	10	
40.5191.00	900	35,4	AR5 A M22	1/4 Npt F	546	19,26	10	✓

Supplied without hand grip nor nozzle

Rated Pressure 250 bar - 25 MPa 3650 psi
 Permissible Pressure 280 bar - 28 MPa 4050 psi
 Rated Flow 40 l/min 10,5 USGpm
 Rated Temperature 160 °C 320 °F

Lances with tip protector and nozzle holder



EXTENSION AR5 A M22 WITH LD7 DOUBLE LANCE

P/N	Length		Tube type	Outlet	Weight			
	mm	in.			gr	oz		
41.0685.00	500	19,7	1/8 Sst.	1/4 Npt F	700	24,7	10	✓
41.0697.00	700	27,5	1/8 Sst.	1/4 Npt F	811	28,6	10	

Rated Pressure 250 bar - 25 MPa 3650 psi
 Permissible Pressure 280 bar - 28 MPa 4050 psi
 Rated Flow 40 l/min 10,5 USGpm
 Rated Temperature 160 °C 320 °F
 Inlet AR5 A M22 2×O-rings



EXTENSION AR5 A M22 WITH LD9 DOUBLE LANCE

P/N	Length		Tube type	Outlet	Weight			
	mm	in.			gr	oz		
41.0919.00	500	19,7	1/4 z.pl.	1/4 Npt F	1006	35,48	15	✓
41.0920.00	500	19,7	1/4 Sst.	1/4 Npt F	923	32,56	15	✓
41.0914.00	700	27,5	1/4 z.pl.	1/4 Npt F	1232	43,45	15	
41.0921.00	700	27,5	1/4 Sst.	1/4 Npt F	1100	38,9	15	✓
41.0911.00	700	27,5	1/8 Sst.	1/4 Npt F	900	31,8	15	

Rated Pressure 250 bar - 25 MPa 3650 psi
 Permissible Pressure 280 bar - 28 MPa 4050 psi
 Rated Flow 40 l/min 10,5 USGpm
 Rated Temperature 160 °C 320 °F
 Inlet AR5 A M22 2×O-rings



1/4 tube lances fitted with plastic protection

SST. EXTENSION AR4 WITH LD9 DOUBLE LANCE

P/N	Length		Tube type	Outlet	Weight			
	mm	in.			gr	oz		
41.0928.00	500	19,7	1/4 Sst.	1/4 Npt F	917	32,34	10	

Rated Pressure 250 bar - 25 MPa 3650 psi
 Permissible Pressure 280 bar - 28 MPa 4050 psi
 Rated Flow 40 l/min 10,5 USGpm
 Rated Temperature 160 °C 320 °F
 Inlet AR4 A M22 hex.



SST. EXTENSION AR16 WITH LDM11 DOUBLE LANCE



P/N	Length		Tube type	Outlet	Weight			
	mm	in.			gr	oz		
41.0255.00	555	21,85	15mm Sst.	1/4 Npt F	780	27,51	10	
41.0275.00	755	29,72	15mm Sst.	1/4 Npt F	894	31,53	10	

Rated Pressure 280 bar - 28 MPa 4050 psi
 Permissible Pressure 310 bar - 31 MPa 4500 psi
 Rated Flow 25 l/min 6,5 USGpm
 Rated Temperature 160 °C 320 °F
 Inlet AR16 A M22 hex.
 Low pressure nozzle 40-30





LANCER5+ARS -COLOR.ROUND GRIP - STAINLESS STEEL

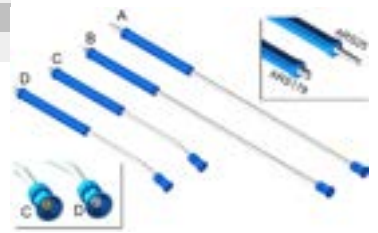

P/N	Length		Inlet	Type	Nozzle type	Tube type	Weight		 
	mm	in.					gr	oz	
40.2303.60	1000	39,4	ARS 25 "A" Kw	A	-	Straight	629	22,19	10
40.2306.60	1000	39,4	ARS 178 "A"	B	-	Straight	629	22,19	10
40.2360.51	600	23,6	ARS 178 "A"	D	25.40 sst	Bent	415	14,64	10

Rated Pressure	250 bar - 25 MPa	3650 psi
Permissible Pressure	280 bar - 28 MPa	4050 psi
Rated Flow	40 l/min	10,5 USGpm
Rated Temperature	160 °C	320 °F
Outlet		1/4 Npt F
Couplings		Stainless steel Ai303
Tube type		1/4 Sst.
Casing colour		Blue



Lances with tip protector and nozzle holder.
1/8 Npt F outlet available on request

R5 LANCE + ARS 23 - A BALL QUICK COUPLING

P/N	Length		Inlet	Outlet	Weight		 
	mm	in.			gr	oz	
40.2272.73	700	27,5	ARS 23 "A"	1/8 Npt F	600	21,2	10
40.2290.23	995	39,2	ARS 23 "A"	1/4 Npt F	670	23,63	10

Rated Pressure	250 bar - 25 MPa	3650 psi
Permissible Pressure	280 bar - 28 MPa	4050 psi
Rated Flow	40 l/min	10,5 USGpm
Rated Temperature	160 °C	320 °F
Material		Stainless steel



R5 LANCE + ARS350 - A - BALL QUICK COUPLING

P/N	Length		Type	Outlet	Weight		 
	mm	in.			gr	oz	
40.5609.10	600	23,6	Straight	1/4 Npt F	548	19,33	25
40.5709.00	700	27,5	Bent	1/4 Npt F	574	20,25	25
40.5909.00	900	35,4	Bent	1/4 Npt F	686	24,2	25

Rated Pressure	250 bar - 25 MPa	3650 psi
Permissible Pressure	280 bar - 28 MPa	4050 psi
Rated Flow	40 l/min	10,5 USGpm
Rated Temperature	160 °C	320 °F
Tube type		Stainl. steel
Inlet		ARS350 "A"



R5 LANCE + ARS25- A-KW - BALL QUICK COUPLING

P/N	Length		Type	Outlet	Weight		 
	mm	in.			gr	oz	
40.5606.10	600	23,6	Straight	1/4 Npt F	518	18,27	25
40.5707.00	700	27,5	Bent	1/4 Npt F	576	20,32	25
40.5907.00	900	35,4	Bent	1/4 Npt F	670	23,63	10

Rated Pressure	250 bar - 25 MPa	3650 psi
Permissible Pressure	280 bar - 28 MPa	4050 psi
Rated Flow	40 l/min	10,5 USGpm
Rated Temperature	160 °C	320 °F
Inlet		ARS 25 "A" Kw
Material		Stainless steel
Hand Grip		R5-420 mm



LS 12 + ARS 23 A - FOAM LANCE + INJECTOR

P/N	Nozzle	Inlet	Weight		5
			mm	gr	
25.1823.21	2,1	ARS 23 "A"	411	14,5	5
Rated Pressure		200 bar - 20 MPa		2900 psi	
Permissible Pressure		220 bar - 22 MPa		3200 psi	
Rated Flow		25 l/min		6,5 USGpm	
Rated Temperature		60 °C		140 °F	

Injector 21.0600.12, not included, is compulsory for foam lance LS12



LS 3 + ARS350 A - FOAM LANCE WITH TANK

P/N	Nozzle type	Nozzle	Inlet	Weight		5
				mm	gr	
25.1525.12	Vertical	1,25	ARS350 "A"	552	19,47	5
Rated Pressure		160 bar - 16 MPa		2300 psi		
Permissible Pressure		180 bar - 18 MPa		2600 psi		
Rated Flow		20 l/min		5,3 USGpm		
Rated Temperature		60 °C		140 °F		
Tank		1 L		0,264 USg		



LS 3 + ARS25- A-KW - FOAM LANCE WITH TANK

P/N	Nozzle	Inlet	Weight		5
			mm	gr	
25.1529.12	1,25	ARS 25 "A" Kw	564	19,89	5
Rated Pressure		160 bar - 16 MPa		2300 psi	
Permissible Pressure		180 bar - 18 MPa		2600 psi	
Rated Flow		20 l/min		5,3 USGpm	
Rated Temperature		60 °C		140 °F	
Nozzle type				Vertical	
Tank		1 L		0,264 USg	



LS 3 + "K" BAYONET COUPLING - FOAM LANCE WITH TANK

P/N	Nozzle	Inlet	Weight		6
			mm	gr	
25.1527.12	1,25	"K" Bayonet coupling	587	20,7	6
Rated Pressure		160 bar - 16 MPa		2300 psi	
Permissible Pressure		180 bar - 18 MPa		2600 psi	
Rated Flow		20 l/min		5,3 USGpm	
Rated Temperature		60 °C		140 °F	
Nozzle type				Vertical	
Tank		1 L		0,264 USg	





GV 5 LANCE + ARS25- A-KW - BALL QUICK COUPLING

P/N	Length		Nozzle	Nozzle Size	Hand Grip	Inlet	Weight		10
	mm	in.					mm	gr	
41.0185.11	768	30,22	1,0	03	1-PFL	ARS 25 "A" Kw	966	34,07	10
Rated Pressure	280 bar - 28 MPa				4050 psi				
Permissible Pressure	310 bar - 31 MPa				4500 psi				
Rated Temperature	90 °C				195 °F				

WARNING: Use only "PA" nozzles (M16).





GV 10 LANCE + ARS178 - BALL QUICK COUPLING

P/N	Length		Nozzle Size	Nozzle	Inlet	Weight		10	
	mm	in.				mm	gr		oz
41.0188.35	956,3	37,65	35	3,7	ARS 178 "A"	1124	39,64	10	
Rated Pressure	210 bar - 21 MPa				3060 psi				
Permissible Pressure	230 bar - 23 MPa				3360 psi				
Rated Flow	80 l/min				21 USGpm				
Rated Temperature	43 °C				110 °F				

WARNING: Use only "PA" nozzles (M16).



LS11 - LANCE WITH INLET STRAINER - STAINLESS STEEL TUBE

P/N	Length		Inlet	Outlet	Weight		8	
	mm	in.			gr	oz		
40.0110.14	700	27,5	1/4 Bsp M	1/4 Npt F	508	17,92	8	
Rated Pressure	180 bar - 18 MPa				2600 psi			
Permissible Pressure	200 bar - 20 MPa				2900 psi			
Rated Flow	30 l/min				8 USGpm			
Rated Temperature	90 °C				195 °F			

Lances with tip protector and nozzle holder.
Suitable for car-wash











S2 -WITHOUT LABEL - VENTED GRIP - ZINC-PLATED TUBE

P/N	Inlet	Length		Outlet	Type	Col.	Weight		20	
		mm	in.				gr	oz		
40.4070.00	1/4 Bspt M	700	27,5	1/4 Npt F	A	Black	554	19,54	20	
40.4090.00	1/4 Bspt M	900	35,4	1/4 Npt F	A	Black	655	23,1	20	
40.4120.00	1/4 Bspt M	1200	47,2	1/4 Npt F	A	Black	832	29,35	20	
30.1903.84R	-	-	-	--	B	RAL5002 Ultramarine Blue	6	0,2	100	
30.1905.84R	-	-	-	--	B	RAL3013 Tomato Red	6	0,2	100	
30.1907.84R	-	-	-	--	B	RAL6032 Signal Green	6	0,2	100	
30.1909.84R	-	-	-	--	B	RAL2012 Salmon Orange	6	0,2	100	
30.1911.84R	-	-	-	--	B	RAL1012 Lemon Yellow	6	0,2	100	
Rated Pressure	350 bar - 35 MPa				5100 psi					
Permissible Pressure	390 bar - 39 MPa				5650 psi					
Rated Flow	40 l/min				10,5 USGpm					
Rated Temperature	160 °C				320 °F					

Lances with tip protector and nozzle holder.
1/8Npt F outlet available on request.



S3 - VENTED GRIP - ZINC-PLATED TUBE



P/N	Inlet	Length		Outlet	Weight		20			
		mm	in.		gr	oz				
40.0535.00	1/4 Bspt M	500	19,7	1/4 Npt F	456	16,08	20			
40.0755.00	1/4 Bspt M	700	27,5	1/4 Npt F	554	19,54	20			
40.0955.00	1/4 Bspt M	900	35,4	1/4 Npt F	655	23,1	20			
40.0955.08	1/4 Npt M	900	35,4	1/4 Npt F	590	20,81	20			
40.0955.50	1/4 Bspt M	900	35,4	1/8 Npt F	655	23,1	20			
40.1255.00	1/4 Bspt M	1200	47,2	1/4 Npt F	832	29,35	20			
40.1255.50	1/4 Bspt M	1200	47,2	1/8 Npt F	832	29,35	20			
40.1555.00	1/4 Bspt M	1500	59	1/4 Npt F	1085	38,27	10			
40.1555.50	1/4 Bspt M	1500	59	1/8 Npt F	1085	38,27	10			
40.1755.00	1/4 Bspt M	1700	66,9	1/4 Npt F	1224	43,17	10			
40.2055.00	1/4 Bspt M	2000	78,7	1/4 Npt F	1360	47,97	10			
40.2055.50	1/4 Bspt M	2000	78,7	1/8 Npt F	1360	47,97	10			
Rated Pressure	250 bar - 25 MPa				3650 psi					
Permissible Pressure	280 bar - 28 MPa				4050 psi					
Rated Flow	40 l/min				10,5 USGpm					
Rated Temperature	160 °C				320 °F					

Lances with tip protector and nozzle holder.
1/8Npt F outlet available on request.





S3 - VENTED GRIP - STAINLESS STEEL TUBE



P/N	Inlet	Length		Outlet	Weight			
		mm	in.		gr	oz		
40.0765.00	1/4 Bspt M	700	27,5	1/4 Npt F	488	17,21	20	✓
40.0965.00	1/4 Bspt M	900	35,4	1/4 Npt F	584	20,6	20	✓
40.0965.08	1/4 Npt M	900	35,4	1/4 Npt F	586	20,69	20	
40.1265.00	1/4 Bspt M	1200	47,2	1/4 Npt F	837	29,52	20	✓
40.1565.00	1/4 Bspt M	1500	59	1/4 Npt F	961	33,9	10	✓
40.1765.00	1/4 Bspt M	1700	66,9	1/4 Npt F	1039	36,65	10	✓
40.2065.00	1/4 Bspt M	2000	78,7	1/4 Npt F	1172	41,34	10	✓

Rated Pressure	250 bar - 25 MPa	3650 psi
Permissible Pressure	280 bar - 28 MPa	4050 psi
Rated Flow	40 l/min	10,5 USGpm
Rated Temperature	160 °C	320 °F

Lances with tip protector and nozzle holder.



S3 -350 VENTED GRIP - STAINLESS STEEL TUBE



P/N	Length		Inlet	Outlet	Weight			
	mm	in.			gr	oz		
40.0258.00	800	31,4	1/4 Bspt M	1/4 Npt F	564	19,89	8	✓
40.0258.50	800	31,4	1/4 Npt M	1/4 Npt F	562	19,82	8	
40.0261.00	1050	41,3	1/4 Bspt M	1/4 Npt F	801	28,25	8	✓
40.0261.50	1050	41,3	1/4 Npt M	1/4 Npt F	800	28,22	8	
40.0264.50	1200	47,2	1/4 Npt M	1/4 Npt F	850	29,98	8	✓

Rated Pressure	350 bar - 35 MPa	5100 psi
Permissible Pressure	390 bar - 39 MPa	5650 psi
Rated Flow	30 l/min	8 USGpm
Rated Temperature	160 °C	320 °F

Lances with tip protector and nozzle holder. Blue insulated grip.



S3 -55 MPA VENTED GRIP - STAINLESS STEEL TUBE



P/N	Length		Inlet	Outlet	Weight			
	mm	in.			gr	oz		
40.0236.00	1050	41,2	1/4 Bsp M	1/4 Npt F	990	39,1	10	✓
40.0240.00	1200	47,2	1/4 Bsp M	1/4 Npt F	1135	40,03	10	✓

Rated Pressure	500 bar - 50 MPa	7250 psi
Permissible Pressure	550 bar - 55 MPa	8000 psi
Rated Flow	40 l/min	10,5 USGpm
Rated Temperature	160 °C	320 °F
Material		Stainless steel

Lances with tip protector and nozzle holder. Red insulated grip.



S6- VENTED GRIP - STAINLESS STEEL TUBE **NEW**



P/N	Length		Inlet	Outlet	Weight			
	mm	in.			gr	oz		
40.0160.12	1200	47,3	3/8 Bsp M	1/4 Npt F	1763	62,18	1	✓
40.0160.80	800	31,5	3/8 Bsp M	1/4 Npt F	1174	41,41	1	✓
40.0170.80	800	31,5	3/8 Bsp M	1/4 Bsp M	1174	41,41	1	✓

Rated Pressure	600 bar - 60 MPa	8700 psi
Permissible Pressure	660 bar - 66 MPa	9500 psi
Rated Flow	60 l/min	15,8 USGpm
Rated Temperature	100 °C	210 °F

Lances with nozzle holder.





SIDE GRIP FOR LANCE S3

P/N	Outlet	Weight			
		gr	oz		
41.0795.00	M 10	82	2,89	25	✓



S7 - RECTANGULAR GRIP - ZINC-PLATED TUBE

P/N	Length		Outlet	Weight			
	mm	in.		gr	oz		
40.4500.00	500	19,7	1/4 Npt F	464	16,37	20	✓
40.4700.00	700	27,5	1/4 Npt F	564	19,9	20	
40.4900.00	900	35,4	1/4 Npt F	658	23,21	20	



Rated Pressure	280 bar - 28 MPa	4050 psi
Permissible Pressure	310 bar - 31 MPa	4500 psi
Rated Flow	40 l/min	10,5 USGpm
Rated Temperature	160 °C	320 °F
Inlet		1/4 Bsp M

Lances with tip protector and nozzle holder.
1/8Npt F outlet available on request.





LANCE R5 - ROUND GRIP - ZINC PLATED TUBE



P/N	Inlet	Length		Outlet	Weight			
		mm	in.		gr	oz		
40.2150.00	1/4 Bsp M	500	19,7	1/4 Npt F	440	15,52	25	✓
40.5500.05	1/4 Npt M	500	19,7	1/4 Npt F	440	15,52	25	
40.5600.05	1/4 Npt M	600	23,62	1/4 Npt F	440	15,52	25	
40.2170.00	1/4 Bsp M	700	27,5	1/4 Npt F	592	20,88	25	✓
40.5700.05	1/4 Npt M	700	27,5	1/4 Npt F	592	20,88	25	
40.2190.00	1/4 Bsp M	900	35,4	1/4 Npt F	692	24,41	25	✓
40.5900.05	1/4 Npt M	900	35,4	1/4 Npt F	670	23,6	25	
40.2220.00	1/4 Bsp M	1200	47,2	1/4 Npt F	842	29,69	25	✓

Rated Pressure	250 bar - 25 MPa	3650 psi
Permissible Pressure	280 bar - 28 MPa	4050 psi
Rated Flow	40 l/min	10,5 USGpm
Rated Temperature	160 °C	320 °F

Lances with tip protector and nozzle holder.
1/8Npt F outlet available on request.



LANCE R5 - ROUND GRIP - STAINLESS STEEL TUBE



P/N	Inlet	Length		Outlet	Weight			
		mm	in.		gr	oz		
40.5502.05	1/4 Npt M	500	20,41	1/4 Npt F	521	18,38	25	
40.5705.00	1/4 Bsp M	700	27,5	1/4 Npt F	521	18,38	25	✓
40.5705.05	1/4 Npt M	700	27,5	1/4 Npt F	532	18,76	25	
40.5905.00	1/4 Bsp M	900	35,4	1/4 Npt F	600	21,16	25	✓
40.5905.05	1/4 Npt M	900	35,4	1/4 Npt F	628	22,15	25	
40.5905.50	1/4 Bsp M	900	35,4	1/8 Npt F	600	21,16	25	

Rated Pressure	250 bar - 25 MPa	3650 psi
Permissible Pressure	280 bar - 28 MPa	4050 psi
Rated Flow	40 l/min	10,5 USGpm
Rated Temperature	160 °C	320 °F

Lances with tip protector and nozzle holder.
1/8 Npt F outlet available on request



LANCE R5 - ROUND GRIP - STAINLESS STEEL

P/N	Length		Casing colour	Outlet	Weight			
	mm	in.			gr	oz		
40.2160.00	500	19,7	Black	1/4 Npt F	414	14,6	10	✓
40.2160.30	500	19,7	Red	1/4 Npt F	408	14,39	10	✓
40.2160.60	500	19,7	Blue	1/4 Npt F	398	14,04	10	✓
40.2300.00	1000	39,4	Black	1/4 Npt F	620	21,87	10	
40.2300.30	1000	39,4	Red	1/4 Npt F	611	21,55	10	
40.2300.60	1000	39,4	Blue	1/4 Npt F	608	21,44	10	✓

Rated Pressure	250 bar - 25 MPa	3650 psi
Permissible Pressure	280 bar - 28 MPa	4050 psi
Rated Flow	40 l/min	10,5 USGpm
Rated Temperature	160 °C	320 °F
Inlet	1/4 Bsp M	
Couplings	Stainless steel Ai303	
Tube type	1/4 Sst.	
Type	Straight	

Lances with tip protector and nozzle holder.
1/8 Npt F outlet available on request



LANCE ML - ROUND GRIP - ZINC PLATED TUBE

P/N	Inlet	Length		Outlet	Weight		
		mm	in.		gr	oz	
40.6200.00	1/4 Bsp M	1200	47,24	1/4 Npt F	982	34,63	25
40.6200.05	1/4 Npt M	1200	47,24	1/4 Npt F	982	34,63	25
40.6500.00	1/4 Bsp M	1500	59	1/4 Npt F	1211	42,71	10
40.6500.05	1/4 Npt M	1500	59	1/4 Npt F	1207	42,57	10
40.6700.00	1/4 Bsp M	1700	66,9	1/4 Npt F	1354	47,76	10
40.6700.05	1/4 Npt M	1700	66,9	1/4 Npt F	1380	48,6	10
40.7000.00	1/4 Bsp M	2000	78,5	1/4 Npt F	1455	51,32	10
40.7000.05	1/4 Npt M	2000	78,5	1/4 Npt F	1455	51,32	10



Rated Pressure	250 bar - 25 MPa	3650 psi
Permissible Pressure	280 bar - 28 MPa	4050 psi
Rated Flow	40 l/min	10,5 USGpm
Rated Temperature	160 °C	320 °F

Lances with tip protector and nozzle holder.

LANCE ML - ROUND GRIP - STAINLESS STEEL TUBE

P/N	Inlet	Length		Outlet	Weight		
		mm	in.		gr	oz	
40.6205.00	1/4 Bsp M	1200	47,2	1/4 Npt F	872	30,76	25 ✓
40.6205.05	1/4 Npt M	1200	47,2	1/4 Npt F	872	30,76	25
40.6505.00	1/4 Bsp M	1500	59	1/4 Npt F	1080	38,09	10 ✓
40.6705.00	1/4 Bsp M	1700	66,9	1/4 Npt F	1300	45,8	10
40.7005.00	1/4 Bsp M	2000	78,7	1/4 Npt F	1295	45,68	10



Rated Pressure	250 bar - 25 MPa	3650 psi
Permissible Pressure	280 bar - 28 MPa	4050 psi
Rated Flow	40 l/min	10,5 USGpm
Rated Temperature	160 °C	320 °F

Lances with tip protector and nozzle holder.

LANCE PFL - MOULDED GRIP - ZINC-PLATED TUBE

P/N	Length		Type	Outlet	Weight		
	mm	in.			gr	oz	
40.7500.00	500	19,8	Bent	1/4 Npt F	390	13,76	25 ✓
40.7502.00	500	19,8	Straight	1/4 Npt F	398	14,04	25
40.7700.00	700	27,5	Bent	1/4 Npt F	488	17,21	25 ✓
40.7700.50	700	27,5	Bent	1/8 Npt F	488	17,21	25
40.7900.00	900	35,4	Bent	1/4 Npt F	599	21,13	25 ✓
40.7900.50	900	35,4	Bent	1/8 Npt F	599	21,13	25
40.8200.00	1200	47,2	Bent	1/4 Npt F	853	30,09	25 ✓
40.8500.00	1500	59	Bent	1/4 Npt F	1024	36,12	10 ✓
40.8700.00	1700	66,9	Bent	1/4 Npt F	1116	39,36	10 ✓
40.9000.00	2000	78,7	Bent	1/4 Npt F	1319	46,52	10 ✓



Rated Pressure	250 bar - 25 MPa	3650 psi
Permissible Pressure	280 bar - 28 MPa	4050 psi
Rated Flow	40 l/min	10,5 USGpm
Rated Temperature	160 °C	320 °F
Inlet		1/4 Bsp M

Lances with tip protector and nozzle holder.
Lances with outlet 1/8Npt F available on request.



LANCE PFL - MOULDED GRIP - SST TUBE

P/N	Length		Type	Outlet	Weight			
	mm	in.			gr	oz		
40.7518.00	500	19,8	Straight	1/4 Npt F	346	12,2	25	✓
40.7722.00	700	27,5	Bent	1/4 Npt F	434	15,31	25	✓
40.9025.00	900	35,4	Bent	1/4 Npt F	507	17,88	25	
40.8216.00	1200	47,2	Bent	1/4 Npt F	738	26,03	10	✓

Rated Pressure	250 bar - 25 MPa	3650 psi
Permissible Pressure	280 bar - 28 MPa	4050 psi
Rated Flow	40 l/min	10,5 USGpm
Rated Temperature	160 °C	320 °F
Inlet		1/4 Bsp M
Tube type		Stainl. steel

Lances with tip protector and nozzle holder.
Lances with outlet 1/8Npt F available on request.



LANCE PFL - STRAIGHT - ZINC-PLATED TUBE

P/N	Length		Hand Grip	Outlet	Weight			
	mm	in.			gr	oz		
40.7300.22	300	11,8	1-PFL	1/4 Bsp M	237	8,36	25	✓
40.7450.22	450	17,7	1-PFL	1/4 Bsp M	316	11,15	25	✓
40.7504.22	500	19,7	1-PFL	1/4 Bsp M	349	12,31	25	
40.7601.22	600	23,6	1-PFL	1/4 Bsp M	396	13,97	25	
40.7705.22	700	27,5	1-PFL	1/4 Bsp M	452	15,94	25	✓
40.7902.22	900	35,4	1-PFL	1/4 Bsp M	554	19,54	25	✓
40.8211.22	1200	47,2	2 -PFL	1/4 Bsp M	818	28,85	25	✓
40.8511.22	1500	59	2 -PFL	1/4 Bsp M	948	33,44	10	
40.9004.22	2000	78,7	3-PFL	1/4 Bsp M	1288	45,43	10	

Rated Pressure	250 bar - 25 MPa	3650 psi
Permissible Pressure	280 bar - 28 MPa	4050 psi
Rated Flow	40 l/min	10,5 USGpm
Rated Temperature	160 °C	320 °F
Inlet		1/4 Bsp M
Tube type		1/4 z.pl.



LANCE PFL - STRAIGHT - STAINLESS STEEL TUBE

P/N	Length		Hand Grip	Outlet	Weight			
	mm	in.			gr	oz		
40.7460.22	450	17,7	1-PFL	1/4 Bsp M	287	10,12	25	✓
40.7710.22	700	27,5	1-PFL	1/4 Bsp M	396	13,97	25	✓
40.8010.22	800	31,5	2 -PFL	1/4 Bsp M	670	23,7	25	
40.9010.22	900	35,4	1-PFL	1/4 Bsp M	479	16,89	25	✓
40.9015.22	900	35,4	2 -PFL	1/4 Bsp M	700	24,7	25	
40.8220.22	1200	47,2	1-PFL	1/4 Bsp M	588	20,74	10	
40.8215.22	1200	47,2	2 -PFL	1/4 Bsp M	684	24,13	25	✓
40.8512.22	1500	59	2 -PFL	1/4 Bsp M	819	28,89	10	

Rated Pressure	250 bar - 25 MPa	3650 psi
Permissible Pressure	280 bar - 28 MPa	4050 psi
Rated Flow	40 l/min	10,5 USGpm
Rated Temperature	160 °C	320 °F
Inlet		1/4 Bsp M



LANCES PFL- BENT - STAINLESS STEEL TUBE

P/N	Length		Hand Grip	Outlet	Weight		
	mm	in.			gr	oz	
40.9016.22	900	35,4	2 -PFL	1/4 Bsp M	568	20,03	10
40.8217.22	1200	47,2	2 -PFL	1/4 Bsp M	686	24,2	10

Rated Pressure	250 bar - 25 MPa	3650 psi
Permissible Pressure	280 bar - 28 MPa	4050 psi
Rated Flow	40 l/min	10,5 USGpm
Rated Temperature	160 °C	320 °F
Inlet		1/4 Bsp M



LANCE AL-F - MOULDED GRIP-STRAIGHT - STAINLESS STEEL TUBE

P/N	Length		Hand Grip	Col.	Weight		
	mm	in.			gr	oz	
40.3500.22	500	19,7	AL-F 7,8 in	Gray	316	11,15	10
40.3502.22	500	19,7	AL-F 7,8 in	Red	316	11,15	10
40.3504.22	500	19,7	AL-F 7,8 in	Blue	316	11,15	10
40.3900.22	1000	39,4	AL-F 12 in	Gray	568	20,03	10
40.3902.22	1000	39,4	AL-F 12 in	Red	572	20,17	10
40.3904.22	1000	39,4	AL-F 12 in	Blue	560	19,75	10

Rated Pressure	250 bar - 25 MPa	3650 psi
Rated Flow	40 l/min	10,5 USGpm
Rated Temperature	90 °C	194 °F
Sterilization Temperature	125 °C	255 °F
Tube type		1/4 Sst.
Inlet		1/4 Bsp M
Outlet		1/4 Bsp M



HANDLE AL-F 340 - MOULDED GRIP - STAINLESS STEEL TUBE

P/N	Length		Hand Grip	Col.	Weight		
	mm	in.			gr	oz	
40.3300.22	340	13,4	AL-F 12 in	Gray	300	10,6	10
40.3302.22	340	13,4	AL-F 12 in	Red	300	10,6	10
40.3304.22	340	13,4	AL-F 12 in	Blue	300	10,6	10

Rated Pressure	250 bar - 25 MPa	3650 psi
Rated Flow	40 l/min	10,5 USGpm
Rated Temperature	90 °C	194 °F
Sterilization Temperature	125 °C	255 °F
Tube type		1/4 Sst.
Inlet		1/4 Bsp M
Outlet		1/4 Bsp M



LANCE AL-F 39MPA - MOULDED GRIP-STRAIGHT - STAINLESS STEEL TUBE

P/N	Length		Hand Grip	Col.	Weight		
	mm	in.			gr	oz	
40.0231.22	800	31,5	AL-F 12 in	Blue	496	17,49	10
40.0232.22	1050	41,34	AL-F 12 in	Blue	610	21,52	10
40.0233.22	1200	47,24	AL-F 12 in	Blue	672	23,7	10

Rated Pressure	390 bar - 39 MPa	5700 psi
Rated Flow	50 l/min	13 USGpm
Rated Temperature	90 °C	194 °F
Sterilization Temperature	125 °C	255 °F
Tube type		1/4 Sst.
Inlet		1/4 Bsp M
Outlet		1/4 Bsp M





LANCE AL-F 55MPa - MOULDED GRIP-STRAIGHT - STAINLESS STEEL TUBE

P/N	Length		Hand Grip	Col.	Weight			
	mm	in.			gr	oz		
40.0221.22	1050	41,33	AL-F 12 in	Red	776	27,37	10	
40.0222.22	1200	47,24	AL-F 12 in	Red	820	28,92	10	

Rated Pressure	550 bar - 55 MPa	8000 psi
Rated Flow	50 l/min	13 USGpm
Rated Temperature	90 °C	194 °F
Sterilization Temperature	125 °C	255 °F
Tube type		1/4 Sst.
Inlet		1/4 Bsp M
Outlet		1/4 Bsp M



LANCE AL-F - ZINC-PLATED TUBE

P/N	Length		Couplings	Weight			
	mm	in.		gr	oz		
40.0210.22	233	9,17	1/4 Bsp MM	128	4,5	50	
40.0208.22	470	18,5	1/4 Bsp MM	274	9,66	50	✓

Rated Pressure	250 bar - 25 MPa	3650 psi
Permissible Pressure	280 bar - 28 MPa	4050 psi
Rated Flow	40 l/min	10,5 USGpm
Rated Temperature	160 °C	320 °F



INSULATED HAND GRIP + TUBE -R5-S3

P/N	Length		Hand Grip	Tube type	Weight			
	mm	in.			gr	oz		
40.0370.00	380	15	S3	Z.pl.steel	384	13,54	30	✓
40.0371.00	380	15	S3	Stainl. steel	346	12,2	30	
40.5453.00	430	17	R5	Z.pl.steel	415	14,64	25	✓

Rated Pressure	250 bar - 25 MPa	3650 psi
Permissible Pressure	280 bar - 28 MPa	4050 psi
Rated Flow	40 l/min	10,5 USGpm
Rated Temperature	160 °C	320 °F
Inlet	1/4 Bsp M (R5) - 1/4 Bsp M (S3)	
Outlet	1/4 Bsp F (R5) - 1/4 Bsp F (S3)	



INSULATED GRIP ML-R5-S3-S4

P/N	Length		Hand Grip	Casing colour	Couplings	Weight			
	mm	in.				gr	oz		
40.5016.23	192	7,5	ML	Black	Hex.19 × d.13 mm	100	3,53	20	
40.5020.23	290	11,4	ML	Black	Hex.19 × d.13 mm	144	5,08	40	✓
40.5022.23	400	15,7	ML	Black	Hex.19 × d.13 mm	191	6,74	40	
40.5024.23	440	17,3	ML	Black	Hex.19 × d.13 mm	208	7,34	40	
40.0041.84R	292	11,5	R5	Black	Hex.19 × d.13 mm	107	3,77	5	✓
40.0044.84R	292	11,5	R5	Blue	Hex.19 × d.13 mm	107	3,77	5	
40.0043.84R	292	11,5	R5	Red	Hex.19 × d.13 mm	107	3,77	5	
40.0042.84R	420	16,5	R5	Black	Hex.19 × d.13 mm	159	5,61	5	
40.9995.98R	300	11,8	S4	Black	Hex.19 × d.13 mm	120	4,23	20	
40.0300.00	360	12,7	S3	Black	Hex.19 × d.13 mm	129	4,55	30	✓
40.0300.05	360	12,7	S3	Black	Hex.19 × d.13,9 mm	136	4,8	30	✓

Rated Temperature	160 °C	320 °F
-------------------	--------	--------



TIP PROTECTOR

P/N	Col.	Weight		1	✓
		gr	oz		
40.0020.00	Black	19	0,67	1	✓
40.0020.30	Red	18	0,63	10	✓
40.0020.60	Blue	18	0,63	10	✓
40.0020.80	Gray	19	0,67	10	✓



Couplings

40.0007.51-61



EXTENSION - ZINC-PLATED TUBE

P/N	Length		Inlet	Outlet	Weight		50	25	30
	mm	in.			gr	oz			
40.5049.00	300	11,8	1/4 Bsp M	1/4 Npt F	197	6,95	50		
40.5060.00	500	19,7	1/4 Bsp M	1/4 Npt F	290	10,23	25	✓	
40.5070.00	700	27,5	1/4 Bsp M	1/4 Npt F	405	14,2	30	✓	

Rated Pressure	250 bar - 25 MPa	3650 psi
Permissible Pressure	280 bar - 28 MPa	4050 psi
Rated Flow	40 l/min	10,5 USGpm
Rated Temperature	160 °C	320 °F

Lances with tip protector and nozzle holder.



EXTENSION - STAINLESS STEEL TUBE

P/N	Length		Inlet	Outlet	Weight		50	✓
	mm	in.			gr	oz		
40.5069.00	500	19,7	1/4 Bsp M	1/4 Npt F	254	8,96	50	✓

Rated Pressure	250 bar - 25 MPa	3650 psi
Permissible Pressure	280 bar - 28 MPa	4050 psi
Rated Flow	40 l/min	10,5 USGpm
Rated Temperature	160 °C	320 °F

Lances with tip protector and nozzle holder.



ZINC PLATED TUBE 1/4 BSP MM

P/N	Length		Outlet	Weight		100	✓	✓
	mm	in.		gr	oz			
40.5056.66R	200	7,9	1/4 Bsp M	96	3,39	100		
40.5050.66R	300	11,8	1/4 Bsp M	160	5,6	50	✓	
40.5033.66R	400	15,7	1/4 Bsp M	198	6,98	25		
40.5055.66R	500	19,7	1/4 Bsp M	246	8,68	50	✓	
40.7602.66R	600	23,6	1/4 Bsp M	298	10,51	50		
40.5702.66R	700	27,5	1/4 Bsp M	364	12,84	25		
40.9421.66R	800	31,5	1/4 Bsp M	430	15,2	25		
40.5902.66R	900	35,4	1/4 Bsp M	450	15,87	25		
40.6008.66R	1000	39,4	1/4 Bsp M	540	18,8	25		
40.8212.66R	1200	47,2	1/4 Bsp M	590	20,81	25		

Rated Pressure	250 bar - 25 MPa	3650 psi
Permissible Pressure	280 bar - 28 MPa	4050 psi
Rated Flow	40 l/min	10,5 USGpm
Inlet		1/4 Bsp M
Hose Ø	13 mm	0,511 in





ZINC PLATED TUBE 1/4 NPT MM

P/N	Length		Outlet	Weight		25	25
	mm	in.		gr	oz		
40.0037.66R	760	30	1/4 Npt M	400	14,1	25	
40.5904.66R	900	35,4	1/4 Npt M	480	16,9	25	

Rated Pressure	250 bar - 25 MPa	3650 psi
Permissible Pressure	280 bar - 28 MPa	4050 psi
Rated Flow	40 l/min	10,5 USGpm
Inlet		1/4 Npt M
Hose Ø	13 mm	0,511 in





STAINLESS STEEL TUBE 1/4 BSP MM

P/N	Length		Outlet	Weight		 	
	mm	in.		gr	oz		
41.0501.56R	300	11,8	1/4 Bsp M	124	4,37	50	✓
40.5061.56R	400	15,7	1/4 Bsp M	168	5,93	50	✓
40.0503.56R	500	19,7	1/4 Bsp M	208	7,34	50	
40.7604.56R	600	23,6	1/4 Bsp M	247	8,78	50	
40.7711.56R	700	27,5	1/4 Bsp M	292	10,3	50	
40.8011.56R	800	31,4	1/4 Bsp M	339	11,95	25	
40.9011.56R	900	35,4	1/4 Bsp M	363	12,8	25	
40.6012.56R	1000	39,9	1/4 Bsp M	422	14,88	25	

Rated Pressure	250 bar - 25 MPa	3650 psi
Permissible Pressure	280 bar - 28 MPa	4050 psi
Rated Flow	40 l/min	10,5 USGpm
Inlet		1/4 Bsp M
Hose Ø	13 mm	0,511 in



STAINLESS STEEL TUBE 1/4 NPT MM

P/N	Length		Outlet	Weight		 	
	mm	in.		gr	oz		
40.0022.56R	203	8	1/4 Npt M	83	2,9	200	
40.9014.56R	400	15,7	1/4 Npt M	178	6,3	50	
40.8012.56R	800	31,4	1/4 Npt M	322	11,4	25	
40.0024.56R	1000	39,9	1/4 Npt M	417	14,7	25	
40.0023.56R	1830	72	1/4 Npt M	770	27,16	25	

Rated Pressure	250 bar - 25 MPa	3650 psi
Permissible Pressure	280 bar - 28 MPa	4050 psi
Rated Flow	40 l/min	10,5 USGpm
Inlet		1/4 Npt M
Hose Ø	13 mm	0,511 in





LD9 - WITH S3 VENTED GRIP

P/N	Length		Tube type	Outlet	Weight			
	mm	in.			gr	oz		
41.0905.00	690	27	1/4 Sst.	1/4 Npt F	934	32,94	10	✓
41.0805.00	890	35	1/4 z.pl.	1/4 Npt F	1300	45,85	10	✓
41.0806.00	890	35	1/4 Sst.	1/4 Npt F	1183	41,73	10	✓
41.0800.00	1090	43	1/4 z.pl.	1/4 Npt F	1528	53,89	10	✓
41.0900.00	1090	43	1/4 Sst.	1/4 Npt F	1347	47,51	10	✓
41.0850.00	1090	43	1/8 Sst.	1/4 Npt F	1208	42,61	10	
41.0902.00	1600	63	1/4 Sst.	1/4 Npt F	1851	65,29	3	

Rated Pressure 250 bar - 25 MPa 3650 psi
 Permissible Pressure 280 bar - 28 MPa 4050 psi
 Rated Flow 40 l/min 10,5 USGpm
 Rated Temperature 160 °C 320 °F
 Inlet 1/4 Bsp M



LD7/3 - WITH S3 VENTED GRIP

P/N	Length		Tube type	Outlet	Weight			
	mm	in.			gr	oz		
41.0600.00	1070	42,1	1/8 Sst.	1/4 Npt F	1106	39	10	
41.0630.00	890	35	1/4 z.pl.	1/4 Npt F	1223	43,14	10	

Rated Pressure 250 bar - 25 MPa 3650 psi
 Permissible Pressure 280 bar - 28 MPa 4050 psi
 Rated Flow 40 l/min 10,5 USGpm
 Rated Temperature 160 °C 320 °F
 Hand Grip S3
 Inlet 1/4 Bsp M



LD7 - WITH R5 ROUND GRIP

P/N	Inlet	Length		Tube type	Weight			
		mm	in.		gr	oz		
41.0682.00	1/4 Bsp M	1050	41,3	1/4 z.pl. × 1/8 Sst.	1060	37,4	10	✓
41.0682.05	1/4 Npt M	1050	41,3	1/4 z.pl. × 1/8 Sst.	1060	37,4	20	
41.0684.00	1/4 Bsp M	850	33,4	1/4 z.pl. × 1/8 Sst.	948	33,44	10	✓
41.0684.05	1/4 Npt M	850	33,4	1/4 z.pl. × 1/8 Sst.	948	33,44	20	
41.0672.00	1/4 Bsp M	1050	41,3	1/4 × 1/8 Sst.	1037	36,58	10	✓
41.0672.05	1/4 Npt M	1050	41,3	1/4 × 1/8 Sst.	1037	36,58	20	
41.0674.00	1/4 Bsp M	850	33,4	1/4 × 1/8 Sst.	922	32,52	10	✓
41.0674.05	1/4 Npt M	850	33,4	1/4 × 1/8 Sst.	922	32,52	20	

Rated Pressure 250 bar - 25 MPa 3650 psi
 Permissible Pressure 280 bar - 28 MPa 4050 psi
 Rated Flow 40 l/min 10,5 USGpm
 Rated Temperature 160 °C 320 °F
 Hand Grip R5
 Outlet 1/4 Npt F



LD - WITH VERTICAL VALVE

P/N	Hand Grip	Length		Tube type	Weight			
		mm	in.		gr	oz		
41.0330.00	1-PFL	850	33,4	1/4 z.pl.	1006	35,48	15	✓
41.0340.00	R5	1050	41,3	1/4 z.pl.	1026	36,19	10	
41.0880.00	LD9+S3+knob	1090	43	1/4 z.pl.	1578	55,66	10	✓
41.0881.00	LD9+S3+knob	1090	43	1/4 Sst.	1365	48,14	10	✓

Rated Pressure 250 bar - 25 MPa 3650 psi
 Permissible Pressure 280 bar - 28 MPa 4050 psi
 Rated Flow 40 l/min 10,5 USGpm
 Rated Temperature 160 °C 320 °F
 Outlet 1/4 Npt F
 Inlet 1/4 Bsp M



LD9 - FRONT SECTION

P/N	Length		Tube type	Outlet	Weight			
	mm	in.			gr	oz		
41.0925.00	300	11,8	1/4 Sst.	1/4 Npt F	639	22,54	10	✓
Rated Pressure	250 bar - 25 MPa				3650 psi			
Permissible Pressure	280 bar - 28 MPa				4050 psi			
Rated Flow	40 l/min				10,5 USGpm			
Rated Temperature	160 °C				320 °F			
Inlet					1/4 Bsp F			



LD7 - FRONT SECTION

P/N	Length		Tube type	Outlet	Weight			
	mm	in.			gr	oz		
41.0698.00	220	8,7	1/8 Sst.	1/4 Npt F	442	15,6	10	✓
41.0390.00	500	19,7	1/8 Sst.	1/4 Npt F	650	22,93	10	✓
Rated Pressure	250 bar - 25 MPa				3650 psi			
Permissible Pressure	280 bar - 28 MPa				4050 psi			
Rated Flow	40 l/min				10,5 USGpm			
Rated Temperature	160 °C				320 °F			
Inlet					1/4 Bsp F			



LD1 - LD3 - WITH S3 VENTED GRIP

P/N	Length		Tube type	Outlet	Weight			
	mm	in.			gr	oz		
41.0700.00	1090	43	1/4 z.pl.	1/4 Npt F	1650	28,45	10	
Sst removable valve seat.								
41.0750.00	1090	43	1/4 z.pl.	1/4 Npt F	1650	28,45	10	
Rated Pressure	310 bar - 31 MPa				4500 psi			
Permissible Pressure	350 bar - 35 MPa				5080 psi			
Rated Flow	40 l/min				10,5 USGpm			
Rated Temperature	160 °C				320 °F			
Hand Grip					S3			
Inlet					1/4 Bsp M			



LD1 - LD3 - WITH PFL 300 ROUND GRIP

P/N	Inlet	Length		Tube type	Weight			
		mm	in.		gr	oz		
41.0710.00	1/4 Bsp M	1050	41,3	1/4 z.pl.	1605	56,85	10	
Sst removable valve seat.								
41.0760.00	1/4 Bsp M	1050	41,3	1/4 z.pl.	1600	56,53	10	
Rated Pressure	310 bar - 31 MPa				4500 psi			
Permissible Pressure	350 bar - 35 MPa				5080 psi			
Rated Flow	40 l/min				10,5 USGpm			
Rated Temperature	160 °C				320 °F			
Hand Grip					1-PFL			
Outlet					1/4 Npt F			





LD9SST. AI303 - FRONT SECTION

P/N	Length		Tube type	Outlet	Weight		5
	mm	in.			gr	oz	
41.0050.00	700	27,6	1/4 Sst.	1/4 Npt F	647	22,8	5
Rated Pressure	250 bar - 25 MPa				3650 psi		
Permissible Pressure	280 bar - 28 MPa				4050 psi		
Rated Flow	40 l/min				10,5 USGpm		
Rated Temperature	160 °C				320 °F		
Material					Stainless steel 303		
Inlet					1/4 Bsp F		



LDM11 - COAXIAL BARREL - WITH S7 GRIP

P/N	Length		Tube type	Outlet	Weight		10
	mm	in.			gr	oz	
41.0295.00	887	34,92	Stainl. steel	1/4 Npt F	1080	38,1	10
41.0315.00	1087	42,8	Stainl. steel	1/4 Npt F	1221	43,07	10
Rated Pressure	280 bar - 28 MPa				4050 psi		
Permissible Pressure	310 bar - 31 MPa				4500 psi		
Rated Flow	25 l/min				6,5 USGpm		
Rated Temperature	160 °C				320 °F		
Inlet					1/4 Bsp M		
Low pressure nozzle					40-30		



LD60SST. AI303 - FRONT SECTION - M24

P/N	Length		Tube type	Outlet	Weight		1
	mm	in.			gr	oz	
41.0000.00	500	19,7	1/4 Sst.	1/4 Npt F	1631	57,5	1
41.0000.70	700	27,6	1/4 Sst.	1/4 Npt F	1951	68,81	1
Rated Pressure	600 bar - 60 MPa				8700 psi		
Permissible Pressure	660 bar - 66 MPa				9500 psi		
Rated Flow	40 l/min				10,5 USGpm		
Rated Temperature	43 °C				109 °F		
Material					Stainless steel 303		
Inlet					AR9 'A' - M24		
Hand Grip					30.5830.00		



ADJUSTABLE ANGLE COUPLINGS LOW PRESSURE - ST. STEEL

P/N	Inlet	Outlet	Weight		10	✓
			gr	oz		
26.1600.00	1/4 Bsp M	1/4 Bsp F	136	4,8	10	✓
Rated Pressure	50 bar - 5 MPa				700 psi	
Rated Flow	40 l/min				10,5 USGpm	
Rated Temperature	90 °C				195 °F	
Material	Stainless steel 303					



ADJUSTABLE ANGLE COUPLINGS HIGH PRESSURE - ST. STEEL

P/N	Inlet	Outlet	Weight		10	✓
			gr	oz		
26.1700.00	1/4 Npt M	1/4 Npt F	94	3,32	10	✓
26.1700.15	1/4 Bsp M	1/4 Bsp F	94	3,32	10	✓
Rated Pressure	275 bar - 27,5 MPa				4000 psi	
Rated Flow	40 l/min				10,5 USGpm	
Rated Temperature	90 °C				195 °F	
Angle of rotation					60°	
Material	Stainless steel 303					



TD1 - DOUBLE NOZZLE HOLDER

P/N	Inlet	Outlet	Weight		25	✓
			gr	oz		
23.0000.00	1/4 Bsp F	2 × 1/4 Npt F	165	5,8	25	✓
23.0000.50	1/4 Bsp F	2 × 1/8 Npt F	174	6,14	25	✓
Rated Pressure	200 bar - 20 MPa				2900 psi	
Permissible Pressure	220 bar - 22 MPa				3200 psi	
Rated Flow	40 l/min				10,5 USGpm	
Rated Temperature	90 °C				195 °F	



TD1P - DOUBLE NOZZLE HOLDER WITH KNOB

P/N	Inlet	Outlet	Weight		25	✓
			gr	oz		
23.0015.00	1/4 Bsp F	2 × 1/4 Npt F	194	6,84	25	✓
23.0015.50	1/4 Bsp F	2 × 1/8 Npt F	200	7	25	
Rated Pressure	200 bar - 20 MPa				2900 psi	
Permissible Pressure	220 bar - 22 MPa				3200 psi	
Rated Flow	40 l/min				10,5 USGpm	
Rated Temperature	90 °C				195 °F	



TR1 - ADJUSTABLE NOZZLE HOLDER

P/N	Inlet	Outlet	Weight		25	✓
			gr	oz		
22.0000.00	1/4 Bsp F	1/4 Npt F	116	4,09	25	✓
22.0000.15	1/4 Bsp F	1/8 Npt F	122	4,3	25	✓
22.0000.05	1/4 Npt F	1/4 Npt F	115	4,06	25	✓
Rated Pressure	250 bar - 25 MPa				3650 psi	
Permissible Pressure	280 bar - 28 MPa				4050 psi	
Rated Flow	30 l/min				8 USGpm	
Rated Temperature	160 °C				320 °F	





TR4 - ADJUSTABLE NOZZLE WITH TIP PROTECTOR

P/N	Inlet	Outlet	Weight		5	
			gr	oz		
22.0100.00	1/4 Bsp F	1/4 Npt F	230	8,11	5	
Rated Pressure	250 bar - 25 MPa				3650 psi	
Permissible Pressure	280 bar - 28 MPa				4050 psi	
Rated Flow	30 l/min				8 USGpm	
Rated Temperature	160 °C				320 °F	



"EG"- 1/4 BSP NOZZLE HOLDER

P/N	Inlet	Outlet	Weight		10	
			gr	oz		
40.0050.00	1/4 Bsp F	--	77	2,72	10	
Rated Pressure	250 bar - 25 MPa				3650 psi	
Permissible Pressure	280 bar - 28 MPa				4050 psi	
Rated Temperature	160 °C				320 °F	



SLUDGE PUMP

P/N	Type	Inlet	Outlet	Nozzle type	Nozzle	Weight		
						mm	gr oz	
28.0750.44R	A	3/8 Bsp F	1" 1/4 Bsp F	1/4 Npt M	0°	329	11,6 3	
13.5039.30R	B	1" 1/4 Bsp M	30 mm hose barb	-	-	32	1,2 5	
13.5040.40R	C	1" 1/4 Bsp M	40 mm hose barb	-	-	32	1,2 5	
Rated Pressure	250 bar - 25 MPa				3650 psi			
Max. flow rate	25 l/min				6,5 USGpm			
Rated Temperature	90 °C				195 °F			

Use only 0° nozzle



GS3 - THREE WAY NOZZLE

P/N	Nozzle Size	Inlet	Weight			
			gr	oz		
25.0800.45	045	1/4 Bsp F	224	7,9	5	✓
25.0800.55	055	1/4 Bsp F	223	7,87	5	✓
25.0800.60	06	1/4 Bsp F	223	7,87	5	✓

Low pressure nozzle		40-20
Rated Pressure	220 bar - 22 MPa	3200 psi
Permissible Pressure	250 bar - 25 MPa	3650 psi
Rated Flow	40 l/min	10,5 USGpm
Rated Temperature	80 °C	175 °F



HL250 - VARIABLE SPRAY ANGLE NOZZLE +HI-LO SETTING

P/N	Nozzle Size	Inlet	Weight			
			gr	oz		
25.0700.10	02	1/4 Bsp F	146	5,15	10	✓
25.0700.11	025	1/4 Bsp F	145	5,11	10	✓
25.0700.12	03	1/4 Bsp F	146	5,15	10	✓
25.0700.25	032	1/4 Bsp F	146	5,15	10	
25.0700.13	035	1/4 Bsp F	146	5,15	10	✓
25.0700.35	037	1/4 Bsp F	145	5,11	10	
25.0700.14	04	1/4 Bsp F	146	5,15	10	✓
25.0700.15	045	1/4 Bsp F	146	5,15	10	✓
25.0700.55	05	1/4 Bsp F	146	5,15	10	✓
25.0700.16	053	1/4 Bsp F	150	5,3	10	
25.0700.65	055	1/4 Bsp F	146	5,15	10	✓
25.0700.66	06	1/4 Bsp F	146	5,15	10	✓
25.0700.18	07	1/4 Bsp F	146	5,15	10	✓
25.0700.20	08	1/4 Bsp F	146	5,15	10	✓

Rated Pressure	250 bar - 25 MPa	3650 psi
Permissible Pressure	280 bar - 28 MPa	4050 psi
Rated Flow	40 l/min	10,5 USGpm
Rated Temperature	90 °C	195 °F



HL280 - VARIABLE SPRAY ANGLE NOZZLE +HI-LO SETTING



P/N	Nozzle Size	Inlet	Weight			
			gr	oz		
25.0950.10	02	1/4 Bsp F	240	8,47	10	
25.0950.11	025	1/4 Bsp F	242	8,54	10	
25.0950.12	03	1/4 Bsp F	240	8,47	10	✓
25.0950.13	035	1/4 Bsp F	240	8,47	10	✓
25.0950.14	04	1/4 Bsp F	240	8,47	10	✓
25.0950.15	045	1/4 Bsp F	240	8,47	10	✓
25.0950.16	053	1/4 Bsp F	240	8,47	10	
25.0950.50	05	1/4 Bsp F	240	8,47	10	✓
25.0950.55	055	1/4 Bsp F	240	8,47	10	✓
25.0950.60	06	1/4 Bsp F	240	8,47	10	✓
25.0950.18	07	1/4 Bsp F	240	8,47	10	✓
25.0950.22	09	1/4 Bsp F	242	8,54	10	✓
25.0950.24	12	1/4 Bsp F	240	8,46	10	✓

Rated Pressure	280 bar - 28 MPa	4050 psi
Permissible Pressure	310 bar - 31 MPa	4500 psi
Rated Flow	30 l/min	8 USGpm
Rated Temperature	90 °C	195 °F







VAN 250 - VARIABLE SPRAY ANGLE NOZZLE

P/N	Nozzle Size	Inlet	Weight			
			gr	oz		
25.0850.11	025	1/4 Bsp F	132	4,66	10	
25.0850.12	03	1/4 Bsp F	130	4,6	10	
25.0850.13	035	1/4 Bsp F	130	4,6	10	
25.0850.14	04	1/4 Bsp F	130	4,6	10	
25.0850.15	045	1/4 Bsp F	132	4,66	10	
25.0850.16	053	1/4 Bsp F	130	4,6	10	
25.0850.20	08	1/4 Bsp F	130	4,6	10	
Rated Pressure	250 bar - 25 MPa		3650 psi			
Permissible Pressure	280 bar - 28 MPa		4050 psi			
Rated Flow	40 l/min		10,5 USGpm			
Rated Temperature	90 °C		195 °F			





VAN - VARIABLE SPRAY ANGLE NOZZLE

P/N	Nozzle Size	Inlet	Weight			
			gr	oz		
25.0900.10	025	1/4 Bsp F	127	4,48	10	✓
25.0900.11	03	1/4 Bsp F	126	4,44	10	✓
25.0900.12	035	1/4 Bsp F	126	4,44	10	✓
25.0900.13	04	1/4 Bsp F	126	4,44	10	✓
25.0900.14	045	1/4 Bsp F	126	4,44	10	✓
25.0900.50	05	1/4 Bsp F	126	4,44	10	✓
25.0900.15	055	1/4 Bsp F	126	4,44	10	✓
25.0900.16	06	1/4 Bsp F	126	4,44	10	✓
25.0900.18	08	1/4 Bsp F	126	4,44	10	✓
25.0900.23	13	1/4 Bsp F	126	4,44	10	✓
25.0900.28	20	1/4 Bsp F	124	4,37	10	✓
Rated Pressure	250 bar - 25 MPa		3650 psi			
Permissible Pressure	280 bar - 28 MPa		4050 psi			
Rated Flow	40 l/min		10,5 USGpm			
Rated Temperature	90 °C		195 °F			



SN1 - STEAM NOZZLE

P/N	Nozzle Size	Inlet	Weight			
			gr	oz		
25.2201.35R	06	1/4 Bsp F	130	4,2	5	✓
Rated Pressure	100 bar - 10 MPa		1450 psi			
Rated Temperature	130 °C		266 °F			



UR12 - ROTATING NOZZLE 1/4BSP F - 12 MPA

P/N	Nozzle Size	Inlet	Weight		5
			gr	oz	
25.1612.25	025	1/4 Bsp F	386	13,61	5
25.1612.30	03	1/4 Bsp F	381	13,44	5
Min. operating pressure	30 bar - 3 MPa		435 psi		
Rated Pressure	120 bar - 12 MPa		1725 psi		
Min. flow rate	3.1 (025 - 30 bar) l/min		0.8 (025 - 435 psi)		
Rated Temperature	100 °C		212 °F		
Min. operating temperature	5 °C		41 °F		



Patent No.: I 0001350055

UR16 - ROTATING NOZZLE 1/4BSP F - 16 MPA

P/N	Nozzle Size	Inlet	Weight		5	
			gr	oz		
25.1680.20	02	1/4 Bsp F	410	14,46	5	✓
Min. operating pressure : 80 bar - 8 MPa (1150 psi)						
25.1680.25	025	1/4 Bsp F	410	14,46	5	✓
25.1680.30	03	1/4 Bsp F	410	14,46	5	✓
25.1680.35	035	1/4 Bsp F	410	14,46	5	✓
25.1680.40	04	1/4 Bsp F	412	14,53	5	✓
25.1680.45	045	1/4 Bsp F	411	14,5	5	✓
25.1680.50	05	1/4 Bsp F	412	14,53	5	✓
25.1680.55	055	1/4 Bsp F	410	14,46	5	
25.1680.60	06	1/4 Bsp F	412	14,53	5	✓
25.1680.65	065	1/4 Bsp F	406	14,32	5	
25.1680.70	07	1/4 Bsp F	410	14,46	5	✓
25.1680.80	08	1/4 Bsp F	412	14,53	5	✓
Min. operating pressure	30 bar - 3 MPa		435 psi			
Rated Pressure	160 bar - 16 MPa		2300 psi			
Min. flow rate	3.1 (025 - 30 bar) l/min		0.8 (025 - 435 psi)			
Max. flow rate	23 (08 - 160 bar) l/min		6,1 (08 - 2300 psi)			
Rated Temperature	100 °C		212 °F			
Min. operating temperature	5 °C		41 °F			



Patent No.: I 0001350055

UR20 - ROTATING NOZZLE 1/4BSP F -20 MPA

P/N	Nozzle Size	Inlet	Weight		5	
			gr	oz		
25.1720.20	02	1/4 Bsp F	292	10,3	5	
25.1720.30	03	1/4 Bsp F	290	10,23	5	✓
25.1720.35	035	1/4 Bsp F	291	10,26	5	✓
25.1720.40	04	1/4 Bsp F	290	10,23	5	✓
25.1720.45	045	1/4 Bsp F	292	10,3	5	✓
25.1720.50	05	1/4 Bsp F	293	10,33	5	✓
25.1720.55	055	1/4 Bsp F	290	10,23	5	✓
25.1720.60	06	1/4 Bsp F	291	10,26	5	
25.1720.65	065	1/4 Bsp F	292	10,3	5	✓
25.1720.70	07	1/4 Bsp F	335	11,8	5	✓
Rated Pressure	200 bar - 20 MPa		3000 psi			
Rated Temperature	90 °C		195 °F			





UR36CT -SST.ROTATING NOZZLE 1/2 NPT F 21 MPA

P/N	Nozzle Size	Inlet	Weight		5	1
			gr	oz		
25.1000.40	04	1/2 Npt F	508	18,14	1	1
25.1000.60	06	1/2 Npt F	508	18,14	1	1
25.1000.80	08	1/2 Npt F	508	18,14	1	1
25.1000.10	10	1/2 Npt F	508	18,14	1	1
25.1000.12	12	1/2 Npt F	508	18,14	1	1

Rated Pressure 210 bar - 21 MPa 3045 psi
 Min. operating pressure 40 bar - 4 MPa 600 psi
 Rated Temperature 60 °C 140 °F
 Min.operating temperature 5 °C 41 °F
 Material Stainless steel

Patent No.: EP 3646953 B1 \ | 0001350055



UR25 - ROTATING NOZZLE 1/4 BSP F - 25 MPA **NEW**

P/N	Nozzle Size	Inlet	Weight		5	✓
			gr	oz		
25.1620.20	02	1/4 Bsp F	410	14,46	5	✓
25.1620.30	03	1/4 Bsp F	410	14,46	5	✓
25.1620.35	035	1/4 Bsp F	410	14,46	5	✓
25.1620.40	04	1/4 Bsp F	410	14,46	5	✓
25.1620.45	045	1/4 Bsp F	410	14,46	5	✓
25.1620.50	05	1/4 Bsp F	411	14,5	5	✓
25.1620.55	055	1/4 Bsp F	412	14,53	5	✓
25.1620.60	06	1/4 Bsp F	411	14,5	5	✓
25.1620.65	065	1/4 Bsp F	410	14,46	5	✓
25.1620.70	07	1/4 Bsp F	412	14,53	5	✓
25.1620.80	08	1/4 Bsp F	410	14,46	5	✓
25.1620.90	09	1/4 Bsp F	410	14,46	5	✓

Min. operating pressure 80 bar - 8 MPa 1150 psi
 Rated Pressure 250 bar - 25 MPa 3650 psi
 Min.flow rate 4,3 (02 - 100 bar) l/min 1,2 (02 - 1450 psi)
 Max. flow rate 29 (08 - 250 bar) l/min 7,7 (08 - 3650 psi)
 Rated Temperature 100 °C 212 °F
 Min.operating temperature 5 °C 41 °F

Patent No.: | 0001350055



UR1 - ROTATING NOZZLE 1/4 NPT M - 35 MPA

P/N	Nozzle Size	Inlet	Weight		5	✓
			gr	oz		
25.1100.11	03	1/4 Npt M	119	4,2	5	✓
25.1100.12	035	1/4 Npt M	118	4,16	5	✓
25.1100.13	04	1/4 Npt M	118	4,16	5	✓
25.1100.14	045	1/4 Npt M	119	4,2	5	✓
25.1100.15	05	1/4 Npt M	119	4,2	5	✓
25.1100.16	06	1/4 Npt M	120	4,23	5	✓
25.1100.18	09	1/4 Npt M	118	4,16	5	✓

Rated Pressure 350 bar - 35 MPa 5100 psi
 Permissible Pressure 390 bar - 39 MPa 5650 psi
 Rated Flow 30 l/min 8 USGpm
 Rated Temperature 80 °C 175 °F



UR32 - ROTATING NOZZLE 1/4BSP F - 35 MPA **NEW**

P/N	Nozzle Size	Inlet	Weight			
			gr	oz		
25.1690.30	03	1/4 Bsp F	410	14,46	5	✓
25.1690.35	035	1/4 Bsp F	410	14,46	5	✓
25.1690.40	04	1/4 Bsp F	412	14,53	5	✓
25.1690.45	045	1/4 Bsp F	412	14,53	5	✓
25.1690.50	05	1/4 Bsp F	410	14,46	5	✓
25.1690.55	055	1/4 Bsp F	410	14,46	5	✓
25.1690.60	06	1/4 Bsp F	410	14,46	5	✓
25.1690.65	065	1/4 Bsp F	410	14,46	5	✓
25.1690.70	07	1/4 Bsp F	410	14,46	5	✓
25.1690.80	08	1/4 Bsp F	411	14,5	5	✓
25.1690.90	09	1/4 Bsp F	411	14,5	5	✓

Rated Pressure 350 bar - 35 MPa 5100 psi
 Min. operating pressure 180 bar - 18 MPa 2600 psi
 Min. flow rate 9,1 (03 - 180 bar) l/min 2,4 (03 - 2600 psi)
 Max. flow rate 34 (08 - 350 bar) l/min 9 (08 - 5100 psi) USGpm
 Rated Temperature 100 °C 212 °F
 Min. operating temperature 5 °C 41 °F
 Material Brass

Patent No.: I 0001350055



UR35 - ROTATING NOZZLE 1/4 BSP F - 35 MPA

P/N	Nozzle Size	Inlet	Weight			
			gr	oz		
25.1735.20	02	1/4 Bsp F	725	25,5	5	
25.1735.30	03	1/4 Bsp F	708	24,97	5	✓
25.1735.35	035	1/4 Bsp F	725	25,5	5	✓
25.1735.40	04	1/4 Bsp F	716	25,25	5	✓
25.1735.45	045	1/4 Bsp F	725	25,5	5	✓
25.1735.50	05	1/4 Bsp F	713	25,15	5	✓
25.1735.55	055	1/4 Bsp F	725	25,5	5	✓
25.1735.60	06	1/4 Bsp F	716	25,25	5	✓
25.1735.65	065	1/4 Bsp F	714	25,18	5	✓
25.1735.80	08	1/4 Bsp F	725	25,5	5	✓
25.1735.90	09	1/4 Bsp F	716	25,25	5	✓
25.1735.10	10	1/4 Bsp F	717	25,29	5	✓
25.1735.12	12	1/4 Bsp F	716	25,25	5	✓
25.1735.19	20	1/4 Bsp F	715	25,22	5	

Rated Pressure 350 bar - 35 MPa 5000 psi
 Rated Temperature 90 °C 194 °F





UR36 -SST.ROTATING NOZZLE 1/4BSP F - 36 MPA

P/N	Nozzle Size	Inlet	Weight		1	2
			gr	oz		
25.1410.30	03	1/4 Bsp F	325	11,46	1	
25.1410.40	04	1/4 Bsp F	326	11,5	1	✓
25.1410.50	05	1/4 Bsp F	322	11,36	1	✓
25.1410.60	06	1/4 Bsp F	325	11,46	1	✓
25.1410.70	07	1/4 Bsp F	325	11,46	1	
25.1410.80	08	1/4 Bsp F	325	11,46	1	

Rated Pressure	360 bar - 36 MPa	5250 psi
Min. flow rate	9,1 (03 - 180 bar) l/min	2,4 (03 - 2600 psi)
Max. flow rate	34 (08 - 360 bar) l/min	9 (08 - 5250 psi) USGpm
Min. operating pressure	180 bar - 18 MPa	2600 psi
Rated Temperature	100 °C	212 °F
Min. operating temperature	5 °C	41 °F
Material	Stainless steel 303	

Patent No.: I 0001350055



UR40 - ROTATING NOZZLE 1/4BSP F - 40MPA/5800 PSI **NEW**

P/N	Nozzle Size	Inlet	Weight		1	2
			gr	oz		
25.1950.30	03	1/4 Bsp F	434	15,3	5	
25.1950.35	035	1/4 Bsp F	434	15,3	5	
25.1950.40	04	1/4 Bsp F	434	15,3	5	
25.1950.45	045	1/4 Bsp F	434	15,3	5	
25.1950.50	05	1/4 Bsp F	434	15,3	5	
25.1950.55	055	1/4 Bsp F	434	15,3	5	
25.1950.60	06	1/4 Bsp F	434	15,3	5	
25.1950.65	065	1/4 Bsp F	434	15,3	5	
25.1950.70	07	1/4 Bsp F	434	15,3	5	
25.1950.80	08	1/4 Bsp F	434	15,3	5	
25.1950.90	09	1/4 Bsp F	434	15,3	5	
25.1950.10	10	1/4 Bsp F	441	15,6	5	

Nozzle and seat in tungsten carbide

25.1950.12	12	1/4 Bsp F	441	15,6	5	
------------	----	-----------	-----	------	---	--

Nozzle and seat in tungsten carbide

Rated Pressure	400 bar - 40 MPa	5800 psi
Min. operating pressure	180 bar - 18 MPa	2600 psi
Rated Temperature	60 °C	140 °F
Min. operating temperature	5 °C	41 °F
Material	Brass	

Patent No.: EP 3646953 B1 \ I 0001350055



UR3 - ROTATING NOZZLE 1/2 BSP F - 50MPA

P/N	Nozzle Size	Inlet	Type	Weight		1	2
				gr	oz		
25.1148.14	045	1/2 Bsp F	1 nozzle	505	17,81	1	
25.1148.16	055	1/2 Bsp F	1 nozzle	505	17,81	1	
25.1150.10	05	1/2 Bsp F	2 nozzles	507	17,88	1	✓
25.1150.11	06	1/2 Bsp F	2 nozzles	510	17,99	1	✓
25.1150.13	08	1/2 Bsp F	2 nozzles	510	17,99	1	✓
25.1150.15	10	1/2 Bsp F	2 nozzles	509	17,95	1	

Rated Pressure	500 bar - 50 MPa	7250 psi
Permissible Pressure	560 bar - 56 MPa	8100 psi
Rated Temperature	80 °C	175 °F



UR50 - ROTATING NOZZLE 1/4 BSP F - 50MPA

P/N	Nozzle Size	Inlet	Weight		
			gr	oz	
25.1750.30	03	1/4 Bsp F	677	23,88	1
25.1750.40	04	1/4 Bsp F	722	25,47	1
25.1750.45	045	1/4 Bsp F	726	25,61	1
25.1750.50	05	1/4 Bsp F	725	25,57	1
25.1750.55	055	1/4 Bsp F	724	25,54	1
25.1750.60	06	1/4 Bsp F	680	23,98	1
25.1750.65	065	1/4 Bsp F	678	23,91	1
25.1750.70	07	1/4 Bsp F	720	25,4	1

Rated Pressure 500 bar - 50 MPa 7250 psi
 Rated Temperature 90 °C 194 °F



UR60 -SST.ROTATING NOZZLE 1/4BSP F - 60 MPA NEW

P/N	Nozzle Size	Inlet	Weight		
			gr	oz	
25.1460.20	02	1/4 Bsp F	540	19,05	1
25.1460.30	03	1/4 Bsp F	540	19,05	1 ✓
25.1460.35	035	1/4 Bsp F	540	19,05	1 ✓
25.1460.40	04	1/4 Bsp F	540	19,05	1 ✓
25.1460.50	05	1/4 Bsp F	540	19,05	1 ✓
25.1460.60	06	1/4 Bsp F	541	19,08	1 ✓
25.1460.65	065	1/4 Bsp F	541	19,08	1 ✓
25.1460.70	07	1/4 Bsp F	540	19,05	1
25.1460.80	08	1/4 Bsp F	540	19,05	1
13.5080.51R		1/2 Bsp F	122	4,31	5

Rated Pressure 600 bar - 60 MPa 8700 psi
 Min. flow rate 6.2 (02 - 180 bar) l/min 1.6 (02 - 2600 psi)
 Max. flow rate 44.6 (08 - 600 bar) l/min 11.8 (08 - 8700 psi)
 Min. operating pressure 180 bar - 18 MPa 2600 psi
 Min. operating temperature 5 °C 41 °F
 Rated Temperature 90 °C 195 °F

Patent No.: I 0001350055



UR70 -SST.ROTATING NOZZLE 1/4BSP F - 70 MPA NEW

P/N	Nozzle Size	Inlet	Weight		
			gr	oz	
25.1570.30	03	1/4 Bsp F	693	24,5	1
25.1570.35	035	1/4 Bsp F	693	24,5	1
25.1570.40	04	1/4 Bsp F	693	24,5	1
25.1570.50	05	1/4 Bsp F	693	24,5	1
25.1570.60	06	1/4 Bsp F	693	24,5	1
25.1570.65	065	1/4 Bsp F	693	24,5	1
25.1570.70	07	1/4 Bsp F	693	24,5	1
25.1570.80	08	1/4 Bsp F	693	24,5	1
13.5074.51R		3/8 Bsp F	92	3,8	5

Rated Pressure 700 bar - 70 MPa 10150 psi
 Min. operating pressure 180 bar - 18 MPa 2600 psi
 Rated Temperature 60 °C 140 °F
 Min. operating temperature 5 °C 41 °F
 Material Stainless steel

Patent No.: EP 3646953 B1 \ I 0001350055





SST.STRAINER X ROTATING NOZZLE 1/4BSP F M- 60 MPA

P/N	Inlet	Outlet	Weight		5	
			gr	oz		
28.0180.00	1/4 Bsp F	1/4 Bsp M	22,4	0,78	5	
Rated Pressure	600 bar - 60 MPa		8700 psi			
Max. flow rate	44,6 l/min		11,8 USGpm			
Rated Temperature	90 °C		195 °F			
Min.operating temperature	5 °C		41 °F			
Filtration parameter	50 mesh		400 µm			
Material	Stainless steel 303					



TS3 -SAND BLASTER - PLASTIC-HARD.STEEL

P/N	Nozzle Size	Inlet	Weight		1
			gr	oz	
25.0080.12	03	1/4 Bsp F	344	12,13	1
25.0080.14	04	1/4 Bsp F	346	12,2	1
Rated Pressure	120 bar - 12 MPa		1750 psi		
Permissible Pressure	140 bar - 14 MPa		2000 psi		
Rated Flow	20 l/min		5,3 USGpm		
Rated Temperature	90 °C		195 °F		



PLF300 EXTENSION WITH TS3 SAND BLASTER - M22

P/N	Hose length		Weight		1
	m	yd	gr	oz	
41.1140.12	3	3,28	1090	38,76	1



TS2 - SAND BLASTER - HARD.STEEL

P/N	Nozzle Size	Inlet	Weight		1	
			gr	oz		
25.0020.12	03	1/4 Bsp F	590	20,81	1	✓
25.0020.14	04	1/4 Bsp F	599	21,13	1	✓
25.0020.15	045	1/4 Bsp F	592	20,88	1	✓
25.0020.16	05	1/4 Bsp F	596	21,02	1	✓
Rated Pressure	120 bar - 12 MPa		1750 psi			
Permissible Pressure	140 bar - 14 MPa		2000 psi			
Rated Flow	20 l/min		5,3 USGpm			
Rated Temperature	90 °C		195 °F			



TS8 - SANDBLASTER - TUNGSTEN CARBIDE

P/N	Nozzle Size	Inlet	Weight		1	
			gr	oz		
25.0000.10	02	1/4 Bsp F	650	22,9	1	
25.0000.12	03	1/4 Bsp F	639	22,54	1	✓
25.0000.14	04	1/4 Bsp F	632	22,29	1	✓
25.0000.15	045	1/4 Bsp F	633	22,32	1	✓
25.0000.16	05	1/4 Bsp F	630	22,22	1	✓
25.0000.18	075	1/4 Bsp F	631	22,26	1	✓
25.0000.20	085	1/4 Bsp F	637	22,47	1	✓
Rated Pressure	250 bar - 25 MPa		3650 psi			
Permissible Pressure	280 bar - 28 MPa		4050 psi			
Rated Flow	40 l/min		10,5 USGpm			
Rated Temperature	90 °C		195 °F			





TS12 - SAND BLASTER 500 BAR - FLAT SPRAY PATTERN

P/N	Inlet	Nozzle Size	Weight		1	✓
			gr	oz		
25.0450.00	1/4 Bsp F	1/4Npt M - 15°	912	32,17	1	✓
Rated Pressure	500 bar - 50 MPa		7250 psi			
Permissible Pressure	560 bar - 56 MPa		8100 psi			
Rated Flow	80 l/min		21 USGpm			
Rated Temperature	90 °C		195 °F			

High pressure nozzles. See 16.1415.XX



TS12 - SAND BLASTER 500 BAR - PENCIL SPRAY PATTERN

P/N	Inlet	Nozzle Size	Weight		1	✓
			gr	oz		
25.0460.00	1/4 Bsp F	1/4Npt M - 0°	998	35,2	1	✓
Rated Pressure	500 bar - 50 MPa		7250 psi			
Permissible Pressure	560 bar - 56 MPa		8100 psi			
Rated Flow	80 l/min		21 USGpm			
Rated Temperature	90 °C		195 °F			

High pressure nozzles. See 16.1401.XX



TS12 - SAND BLASTER 500BAR-EXTND. - PENCIL SPRAY PATTERN

P/N	Inlet	Nozzle Size	Weight		1	✓
			gr	oz		
25.0480.00	1/4 Bsp F	1/4Npt M - 0°	1620	57,1	1	✓
Rated Pressure	500 bar - 50 MPa		7250 psi			
Permissible Pressure	560 bar - 56 MPa		8100 psi			
Rated Flow	80 l/min		21 USGpm			
Rated Temperature	90 °C		195 °F			

High pressure nozzles. See 16.1415.XX



TS12 - 0° 50MPA NOZZLE - (CONV.+O-RING)

P/N	Nozzle Size	Inlet	Type	Weight		2	✓
				gr	oz		
16.1401.40	0° -04	1/4 Npt M	Compl.nozzle	19	0,67	2	✓
16.1401.50	0° -05	1/4 Npt M	Compl.nozzle	19	0,67	2	✓
16.1401.55	0° -055	1/4 Npt M	Compl.nozzle	18	0,6	2	✓
10.3002.01R	-	-	O-ring	1	1	10	
25.0506.51R	-	-	Guid.vane	1	1	3	

Rated Pressure 500 bar - 50 MPa 7250 psi

These nozzles are compulsory for use under high pressure - 500 bar - 7250 psi





S10 - ADJUSTABLE PROBE

P/N	Length		Inlet	Weight		1	✓
	mm	in.		gr	oz		
25.0300.00	500	19,7	13 mm (TS8-TS2-TS3)	610	21,5	1	✓
25.0300.20	500	19,7	21 mm (TS12)	662	23,35	1	✓

Material Stainless steel



LOW PRESSURE NOZZLES

P/N	Inlet	Nozzle type	Nozzle Size	Type	Material	Weight		 	
						gr	oz		
16.1350.40	1/4 Npt M	50°	40	A	Brass	14	0,49	10	✓
16.1345.40	1/4 Bspt M	25	40	B	Stainless steel 303	16	0,56	10	✓
16.1327.40	1/4 Bspt M	25	40	C	Brass	16	0,56	10	
16.1346.30R	1/4 Npt M	60°	30	D	Pom	16	0,56	10	
16.1360.20	1/2 Bst M	50°	200	E	Brass	16	0,56	3	✓
16.1361.20	1/2 Bst M	50°	200	F	Stainless steel 303	16	0,56	2	✓

Rated Pressure 50 bar - 5 MPa 715 psi

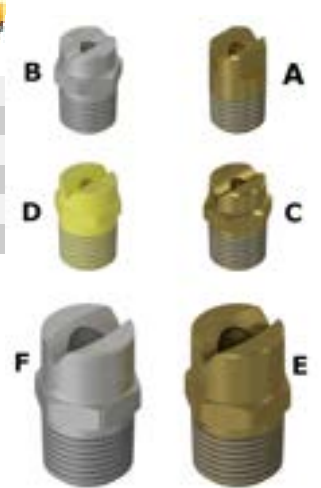

AI303 SST. HIGH PRESSURE NOZZLE M4 - 0°



P/N	Nozzle Size	Inlet	External diameter		Weight		 	
			mm	in	gr	oz		
25.1189.51R	016	Hex.2 mm	4	1,58	0,86	0,03	10	
25.1190.51R	02	Hex.2 mm	4	01,58	0,86	0,03	10	
25.1191.51R	023	Hex.2 mm	4	1,58	0,86	0,03	10	
25.1091.51R	025	Hex.2 mm	4	1,58	0,86	0,03	10	
25.1092.51R	03	Hex.2 mm	4	1,58	0,86	0,03	10	
25.1193.51R	032	Hex.2 mm	4	1,58	0,86	0,03	10	
25.1093.51R	035	Hex.2 mm	4	1,58	0,86	0,03	10	
25.1098.51R	037	Hex.2 mm	4	1,58	0,86	0,03	10	
25.1094.51R	04	Hex.2 mm	4	1,58	0,86	0,03	10	
25.1095.51R	045	Hex.2 mm	4	1,58	0,86	0,03	10	
25.1195.51R	05	Hex.2 mm	2	1,58	0,86	0,03	10	
25.1196.51R	053	Hex.2 mm	4	1,58	0,86	0,03	10	
25.1197.51R	055	Hex.2 mm	4	1,58	0,86	0,03	10	
25.1186.51R	06	Hex.2 mm	4	1,58	0,86	0,03	10	
25.1199.51R	07	Hex.2 mm	4	1,58	0,86	0,03	10	
25.1085.51R	08	Hex.2 mm	4	1,58	0,86	0,03	10	✓
25.0958.51R	09	Hex.2,5 mm	4,5	1,78	0,84	0,03	10	
25.0959.51R	12	Hex.2,5 mm	4,5	1,78	0,84	0,03	10	

Rated Pressure 250 bar - 25 MPa 3650 psi
 Material Stainless steel 303
 Inlet M 4 x 0,7 mm

0° pencil jet nozzles



AI 303 SST. HIGH PRESSURE NOZZLE M4 SHORT - 0°

P/N	Nozzle Size	Inlet	External diameter		Weight		 	
			mm	in	gr	oz		
80.0350.51R	02	Hex.2 mm	4	01,58	0,86	0,03	10	
80.0351.51R	025	Hex.2 mm	4	01,58	0,86	0,03	10	✓
80.0352.51R	03	Hex.2 mm	4	01,58	0,86	0,03	10	
80.0353.51R	035	Hex.2 mm	4	01,58	0,86	0,03	10	✓
80.0354.51R	04	Hex.2 mm	4	01,58	0,86	0,03	10	✓

Rated Pressure 250 bar - 25 MPa 3650 psi
 Material Stainless steel 303
 Inlet M 4 x 0,7 mm

0° pencil jet nozzles





AI 316L SST. HIGH PRESSURE NOZZLE M4 SHORT - 0°

P/N	Nozzle Size	Inlet	External diameter		Weight		mm	in	gr	oz	4
			mm	in	gr	oz					
80.0899.60R	016	Hex.2 mm	4	1,58	0,86	0,03	4				
80.0892.60R	02	Hex.2 mm	4	1,58	0,86	0,03	4				
80.0893.60R	025	Hex.2 mm	4	1,58	0,86	0,03	4				
80.0882.60R	03	Hex.2 mm	4	1,58	0,86	0,03	4				
80.0883.60R	035	Hex.2 mm	4	1,58	0,86	0,03	4				
80.0884.60R	04	Hex.2 mm	4	1,58	0,86	0,03	4				
80.0885.60R	045	Hex.2 mm	4	1,58	0,86	0,03	4				
80.0895.60R	05	Hex.2 mm	4	1,58	0,86	0,03	4				
80.0886.60R	055	Hex.2 mm	4	1,58	0,86	0,03	4				
80.0887.60R	06	Hex.2 mm	4	1,58	0,86	0,03	4				
80.0888.60R	065	Hex.2 mm	4	1,58	0,86	0,03	4				
80.0889.60R	07	Hex.2 mm	4	1,58	0,86	0,03	4				
80.0890.60R	-	Hex.2 mm	4	1,58	0,86	0,03	4				



Rated Pressure 250 bar - 25 MPa 3650 psi
 Material Stainless steel Ai316
 Inlet M 4 x 0,7 mm

0° pencil jet nozzles

SST. HIGH PRESSURE NOZZLE M6 - 0° **NEW**

P/N	Nozzle Size	Weight		mm	oz	10
		gr	oz			
16.2198.00R	-	1	0,04	10		
25.1250.51R	015	1	0,04	10		
25.1251.51R	025	1	0,04	10		✓
25.1261.51R	04	1	0,04	10		
25.1253.51R	05	1	0,04	10		
25.1257.51R	07	1	0,04	10		✓
25.1258.51R	075	1	0,04	10		✓
25.1259.51R	08	1	0,04	10		✓
25.1260.51R	10	1	0,04	10		✓
25.1263.51R	12	1	0,04	10		✓
25.1265.51R	15	1	0,04	10		



Rated Pressure 250 bar - 25 MPa 3650 psi
 Material Stainless steel
 Inlet M 6 x 1 mm

0° pencil jet nozzles

HIGH PRESSURE NOZZLE M15X1 - 0°

P/N	Nozzle Size	Hole size		Weight		mm	oz	10
		mm	in	gr	oz			
16.1280.12R	035	1,2	0,05	19	0,67	10		
16.1280.15R	06	1,5	0,06	19	0,67	10		
16.1280.18R	075	1,8	0,07	19	0,67	10		
16.1280.35R	25	3,5	0,14	19	0,67	10		



Rated Pressure 250 bar - 25 MPa 3650 psi
 Nozzle material Alumina
 Inlet M15x1 M

0° pencil jet nozzles

HIGH PRESSURE NOZZLE M15X1 - 0°- NI.PL.BRASS

P/N	Nozzle Size	Hole size		Weight		
		mm	in	gr	oz	
16.1270.35R	30	3,5	0,14	21	0,74	10
16.1270.40R	30	4,0	0,16	21	0,74	10
16.1270.45R	40	4,5	0,18	21	0,74	10
16.1270.50R	55	5	0,20	20	0,71	10
16.1270.55R	65	5,5	0,22	21	0,74	10
16.1270.60R	80	6	0,24	21	0,74	10
16.1270.70R	90.00	7	0,28	21	0,74	10

Rated Pressure 250 bar - 25 MPa 3650 psi
 Nozzle material Brass
 Inlet M15x1 M

0° pencil jet nozzles



SST HIGH PRESSURE NOZZLE M16X2 - 0°

P/N	Nozzle Size	Hole size		Weight		
		mm	in	gr	oz	
41.0121.51R	03	1	0,04	19	0,67	10
41.0122.51R	12	2	0,08	19	0,67	10 ✓
41.0123.51R	25	3	0,12	19	0,67	10
41.0133.51R	35	3,7	0,15	19	0,67	10
41.0134.51R	40	3,9	0,155	19	0,67	10
41.0135.51R	50	4,4	0,173	19	0,67	10
41.0147.51R	90.00	7	0,275	19	0,67	10

Rated Pressure 250 bar - 25 MPa 3650 psi
 Nozzle material St. steel
 Inlet M16 x 2 mm

0° pencil jet nozzles



SST. HIGH PRESSURE NOZZLE 1/4NPT M 0°+GUIDE VANE

P/N	Nozzle Size	Inlet	Weight		
			gr	oz	
16.1380.30R	03	1/4 Npt M	19	0,7	10
16.1380.35R	035	1/4 Npt M	19	0,7	10
16.1380.40R	04	1/4 Npt M	19	0,7	10 ✓
16.1380.45R	045	1/4 Npt M	19	0,7	10
16.1380.50R	05	1/4 Npt M	19	0,7	10
16.1380.55R	055	1/4 Npt M	19	0,7	10
16.1380.60R	06	1/4 Npt M	19	0,7	10
16.1380.65R	065	1/4 Npt M	19	0,7	10
16.1380.70R	07	1/4 Npt M	19	0,67	10 ✓

Rated Pressure 250 bar - 25 MPa 3650 psi
 Material Stainless steel

0° pencil jet nozzles with sst guide vane





SST. HIGH PRESSURE NOZZLE 1/8NPT M 0°+GUIDE VANE

P/N	Nozzle Size	Inlet	Weight		10	
			gr	oz		
16.1363.20R	02	1/8 Npt M	14	0,5	10	
16.1363.30R	03	1/8 Npt M	14	0,49	10	
16.1363.40R	04	1/8 Npt M	14	0,5	10	✓
16.1363.45R	045	1/8 Npt M	14	0,5	10	
16.1363.50R	05	1/8 Npt M	14	0,49	10	
16.1363.60R	06	1/8 Npt M	14	0,5	10	
16.1363.70R	07	1/8 Npt M	14	0,5	10	
16.1363.80R	08	1/8 Npt M	14	0,5	10	
16.1363.90R	09	1/8 Npt M	14	0,5	10	



Rated Pressure 250 bar - 25 MPa 3650 psi
Material Stainless steel

0° pencil jet nozzles with sst guide vane

SST EXTENDED NOZZLE 1/4 NPT M- 0°+ GUIDE VANE

P/N	Nozzle Size	Inlet	Weight		2	
			gr	oz		
80.0418.23R	07	1/4 Npt M	43	1,5	2	✓
80.0419.23R	08	1/4 Npt M	43	1,5	2	✓
80.0420.23R	09	1/4 Npt M	43	1,5	2	✓
80.0421.23R	095	1/4 Npt M	43	1,5	2	✓
80.0422.23R	11	1/4 Npt M	43	1,5	2	✓
80.0423.23R	12	1/4 Npt M	43	1,5	2	✓
80.0424.23R	13	1/4 Npt M	43	1,5	2	✓
80.0425.23R	14	1/4 Npt M	43	1,5	2	✓
80.0426.23R	15	1/4 Npt M	43	1,5	2	
80.0427.23R	16	1/4 Npt M	43	1,5	2	
80.0428.23R	18	1/4 Npt M	43	1,5	2	✓
80.0429.23R	19	1/4 Npt M	43	1,5	2	
80.0430.23R	20	1/4 Npt M	43	1,5	2	✓
80.0435.23R	25	1/4 Npt M	43	1,5	2	
80.0440.23R	30	1/4 Npt M	43	1,5	2	✓
80.0444.23R	40	1/4 Npt M	43	1,5	2	✓
80.0445.23R	50	1/4 Npt M	43	1,5	2	✓



Rated Pressure 250 bar - 25 MPa 3650 psi
Material Stainless steel

The use of protection 25.4822.00 is recommended when mounting these nozzles on a A80 R tank cleaner.

SST HIGH PRESSURE NOZZLE 1/4 NPT M - 5°



P/N	Nozzle type	Inlet	Weight		10	
			gr	oz		
16.1305.30R	03	1/4 Npt M	16	0,56	10	
16.1305.40R	04	1/4 Npt M	18	0,6	10	
16.1305.50R	05	1/4 Npt M	18	0,6	10	
16.1305.60R	06	1/4 Npt M	18	0,6	10	
16.1305.70R	07	1/4 Npt M	18	0,6	10	
16.1305.80R	08	1/4 Npt M	18	0,6	10	



Rated Pressure 250 bar - 25 MPa 3650 psi
Material Stainless steel





SST HIGH PRESSURE NOZZLE 1/4 NPT M 15°

P/N	Nozzle Size	Inlet	Weight				
			gr	oz			
16.1315.30R	03	1/4 Npt M	16	0,56	10	✓	
16.1315.35R	035	1/4 Npt M	16	0,56	10	✓	
16.1315.40R	04	1/4 Npt M	16	0,56	10	✓	
16.1315.45R	045	1/4 Npt M	16	0,56	10	✓	
16.1315.50R	05	1/4 Npt M	16	0,56	10	✓	
16.1315.55R	055	1/4 Npt M	16	0,56	10	✓	
16.1315.60R	06	1/4 Npt M	16	0,56	10	✓	
16.1315.65R	065	1/4 Npt M	16	0,56	10	✓	
16.1315.70R	07	1/4 Npt M	16	0,56	10	✓	
16.1315.80R	08	1/4 Npt M	16	0,56	10	✓	
16.1315.90R	09	1/4 Npt M	16	0,56	10	✓	

Rated Pressure 250 bar - 25 MPa 3650 psi
Material Stainless steel





SST HIGH PRESSURE NOZZLE 1/8NPT M 15°

P/N	Nozzle Size	Inlet	Weight				
			gr	oz			
16.1316.20R	02	1/8 Npt M	12	0,42	3	✓	
16.1316.30R	03	1/8 Npt M	12	0,42	3	✓	
16.1316.40R	04	1/8 Npt M	12	0,42	3	✓	
16.1316.45R	045	1/8 Npt M	12	0,42	3	✓	
16.1316.55R	055	1/8 Npt M	14	0,5	3		
16.1316.60R	06	1/8 Npt M	14	0,5	3		
16.1316.70R	07	1/8 Npt M	14	0,5	3		
16.1316.90R	09	1/8 Npt M	14	0,5	3		

Rated Pressure 250 bar - 25 MPa 3650 psi
Material Stainless steel



SST HIGH PRESSURE NOZZLE 1/4 NPT M 25°

P/N	Nozzle Size	Inlet	Weight				
			gr	oz			
16.1325.30R	03	1/4 Npt M	16	0,56	10	✓	
16.1325.35R	035	1/4 Npt M	16	0,56	10	✓	
16.1325.40R	04	1/4 Npt M	16	0,56	10	✓	
16.1325.45R	045	1/4 Npt M	16	0,56	10	✓	
16.1325.50R	05	1/4 Npt M	16	0,56	10	✓	
16.1325.55R	055	1/4 Npt M	16	0,56	10	✓	
16.1325.60R	06	1/4 Npt M	16	0,56	10	✓	
16.1325.65R	065	1/4 Npt M	16	0,56	10	✓	
16.1325.70R	07	1/4 Npt M	16	0,56	10	✓	
16.1325.80R	08	1/4 Npt M	16	0,56	10	✓	

Rated Pressure 250 bar - 25 MPa 3650 psi
Material Stainless steel





NOZZLE 0° - 100MPa SAPPHIRE -1/4-1/8

P/N	Hole size		Inlet	Weight		
	mm	in		gr	oz	
16.1408.40R	1,4	0,055	1/8 Npt M	11	0,4	2
16.1408.54R	1,60	0,063	1/8 Npt M	11	0,4	2
16.1408.60R	1,70	0,067	1/8 Npt M	11	0,4	2



Nozzle type 0°
 Rated Pressure 1000 bar - 100 MPa 14500 psi
 Material Stainless steel
 Nozzle material Sapphire

These nozzles are compulsory for use under high pressure - 500 -1000 bar - 7250 -14500 psi

HIGH PRESSURE 50MPa NOZZLE - 15°

P/N	Nozzle Size	Inlet	Weight		
			gr	oz	
16.1415.40	15° -04	1/4 Npt M	17	0,6	2 ✓
16.1415.50	15° -05	1/4 Npt M	17	0,6	2
16.1415.55	15° -055	1/4 Npt M	17	0,6	2
16.1415.80	15° -08	1/4 Npt M	17	0,6	2
16.1415.90	15° -09	1/4 Npt M	17	0,6	2



Rated Pressure 500 bar - 50 MPa 7250 psi

These nozzles are compulsory for use under high pressure - 500 bar - 7250 psi - Nozzle suitable for TS12

NOZZLE 40° 50MPa TUNG.CARBIDE -1/4-1/8

P/N	Hole size		Inlet	Weight		
	mm	in		gr	oz	
16.1444.20R	0,94	0,037	1/4 Npt M	18	0,6	2
16.1444.30R	1,14	0,045	1/4 Npt M	18	0,6	2
16.1444.49R	1,45	0,057	1/4 Npt M	18	0,6	2
16.1444.55R	1,55	0,061	1/4 Npt M	18	0,6	2
16.1448.20R	0,94	0,037	1/8 Npt M	11	0,4	2
16.1448.30R	1,14	0,045	1/8 Npt M	11	0,4	2
16.1448.38R	1,29	0,05	1/8 Npt M	11	0,4	2
16.1448.49R	1,45	0,057	1/8 Npt M	11	0,4	2
16.1448.55R	1,55	0,061	1/8 Npt M	11	0,4	2



Nozzle type 40°
 Rated Pressure 500 bar - 50 MPa 7250 psi
 Material Stainless steel
 Nozzle material Tungsten carbide

These nozzles are compulsory for use under high pressure - 500 bar - 7250 psi

ST 3 DRAIN CLEANING NOZZLE 1/8 BSP F

P/N	Nozzle Size	Weight		3	✓
		gr	oz		
25.1203.30	03	10	0,35	3	✓
25.1203.40	04	10	0,35	3	✓
25.1203.50	05	10	0,35	3	✓
25.1203.60	06	10	0,35	3	✓
25.1203.70	07	10	0,35	3	
25.1203.80	08	10	0,35	3	

Rated Pressure: 350 bar - 35 MPa / 5100 psi
 Material: Stainless steel 303
 No. of Ports: 3
 Inlet: 1/8 Bsp F



ST 3 DRAIN CLEANING NOZZLE 1/4 BSP F

P/N	Nozzle Size	Weight		3	✓
		gr	oz		
25.1213.30	03	18	0,63	3	✓
25.1213.40	04	18	0,63	3	✓
25.1213.50	05	18	0,63	3	✓
25.1213.60	06	18	0,63	3	✓
25.1213.70	07	18	0,63	3	
25.1213.80	08	18	0,63	3	

Rated Pressure: 350 bar - 35 MPa / 5100 psi
 Material: Stainless steel 303
 No. of Ports: 3
 Inlet: 1/4 Bsp F



DRAIN CLEANING NOZZLE 1/4 BSP M

P/N	Rated pr.		Nozzle Size	No. of Ports	Weight		10	✓
	bar - MPa	psi			gr	oz		
25.1201.51R	250 - 25	3650	04	4	23	0,81	10	✓
25.1216.31R	120 - 12	1750	035	3	24	0,8	10	✓

Mater : Brass
 Inlet: 1/4 Bsp M
 Material: Stainless steel



ST 3 DRAIN CLEANING NOZZLE 3/8 BSP F

P/N	Nozzle Size	Weight		3	✓
		gr	oz		
25.1223.30	03	34	1,2	3	
25.1223.40	04	34	1,2	3	✓
25.1223.50	05	34	1,2	3	
25.1223.60	06	34	1,2	3	
25.1223.70	07	34	1,2	3	
25.1223.80	08	34	1,2	3	✓

Rated Pressure: 350 bar - 35 MPa / 5100 psi
 Material: Stainless steel 303
 No. of Ports: 3
 Inlet: 3/8 Bsp F





ST 4 DRAIN CLEANING NOZZLE 1/8 BSP F

P/N	Nozzle Size	Weight		3	✓
		gr	oz		
25.1204.30	03	10	0,35	3	✓
25.1204.40	04	10	0,35	3	✓
25.1204.50	05	10	0,35	3	✓
25.1204.60	06	10	0,35	3	✓
25.1204.70	07	10	0,35	3	✓
25.1204.80	08	10	0,35	3	

Rated Pressure 350 bar - 35 MPa 5100 psi
 Material Stainless steel 303
 No. of Ports 4
 Inlet 1/8 Bsp F



ST 4 DRAIN CLEANING NOZZLE 1/4 BSP F

P/N	Nozzle Size	Weight		3	✓
		gr	oz		
25.1214.30	03	18	0,63	3	✓
25.1214.40	04	18	0,63	3	✓
25.1214.50	05	18	0,63	3	✓
25.1214.60	06	18	0,63	3	✓
25.1214.70	07	18	0,63	3	
25.1214.80	08	18	0,63	3	✓

Rated Pressure 350 bar - 35 MPa 5100 psi
 Material Stainless steel 303
 No. of Ports 4
 Inlet 1/4 Bsp F



ST 4 DRAIN CLEANING NOZZLE 3/8 BSP F

P/N	Nozzle Size	Weight		3	✓
		gr	oz		
25.1224.30	03	34	1,2	3	
25.1224.40	04	35	1,23	3	✓
25.1224.50	05	34	1,2	3	✓
25.1224.60	06	34	1,2	3	✓
25.1224.70	07	34	1,2	3	
25.1224.80	08	34	1,2	3	✓
25.1224.12	12	34	1,2	3	

Rated Pressure 350 bar - 35 MPa 5100 psi
 Material Stainless steel 303
 No. of Ports 4
 Inlet 3/8 Bsp F



DRAIN CLEANING NOZZLE 3/8 BSP M

P/N	Nozzle Size	No. of Ports	Inlet	Weight		5	✓
				gr	oz		
25.1210.51R	06	9	3/8 Bsp M	36	1,2	5	✓

Rated Pressure 250 bar - 25 MPa 3650 psi
 Material Stainless steel



STR-1/8 ROTAT. DRAIN CLEANING NOZZLE 1/8 BSP F

P/N	Nozzle Size	Weight		3	
		gr	oz		
25.1285.30	03	30	1,06	3	✓
25.1285.40	04	30	1,06	3	✓
25.1285.50	05	30	1,06	3	✓
25.1285.60	06	30	1,06	3	✓
25.1285.70	07	30	1,06	3	
25.1285.80	08	30	1,06	3	

Rated Pressure	250 bar - 25 MPa	3650 psi
Material		Ai303+Bz-Al
No. of Ports		3
Inlet		1/8 Bsp F
External diameter	18 mm	0,71 in



STR-1/4 ROTAT. DRAIN CLEANING NOZZLE 1/4 BSP F

P/N	Nozzle Size	Weight		3	
		gr	oz		
25.1290.30	03	35	1,23	3	✓
25.1290.40	04	34	1,2	3	✓
25.1290.50	05	35	1,23	3	✓
25.1290.60	06	35	1,23	3	✓
25.1290.70	07	35	1,23	3	✓
25.1290.80	08	35	1,23	3	✓

Rated Pressure	250 bar - 25 MPa	3650 psi
Material		Ai303+Bz-Al
No. of Ports		3
Inlet		1/4 Bsp F
External diameter	18 mm	0,71 in



STR-3/8 ROTAT. DRAIN CLEANING NOZZLE 3/8 BSP F



P/N	Nozzle Size	Weight		3	
		gr	oz		
25.1295.60	06	63	2,22	3	✓
25.1295.70	07	65	2,3	3	✓
25.1295.80	08	65	2,3	3	✓
25.1295.90	09	65	2,3	3	✓
25.1295.10	10	65	2,3	3	✓
25.1295.11	11	63	2,22	3	✓

Rated Pressure	250 bar - 25 MPa	3650 psi
Material		Ai303+Bz-Al
No. of Ports		3
Inlet		3/8 Bsp F
External diameter	22 mm	0,87 in







RU - DRAIN CLEANING NICK-PLATED STEEL NOZZLE

P/N	Nozzle Size	No. of Ports	Inlet	Weight			
				gr	oz		
25.1236.00	-	6	1/2 Bsp F	70	2,47	1	✓
25.1236.20	20	6	1/2 Bsp F	84	2,96	1	✓
25.1236.30	30	6	1/2 Bsp F	84	2,96	1	✓
25.1237.00	-	7	3/4 Bsp F	242	8,54	1	✓
25.1237.30	30	7	3/4 Bsp F	250	8,82	1	
25.1237.40	40	7	3/4 Bsp F	250	8,82	1	✓
25.1237.50	50	7	3/4 Bsp F	250	8,82	1	
25.1237.60	60	7	3/4 Bsp F	250	8,82	1	
25.1239.00	-	7	1 Bsp F	351	12,38	1	✓
25.1239.50	50	7	1 Bsp F	345	12,17	1	
25.1239.60	60	7	1 Bsp F	345	12,17	1	
25.1239.80	80	7	1 Bsp F	346	12,2	1	✓

Rated Pressure 300 bar - 30 MPa 4350 psi
 Rated Temperature 160 °C 320 °F
 Material Nick.pl.steel





RR-TS - ROTATING DRAIN CLEANING STAINLESS STEEL NOZZLE -SPHERICAL HEAD

P/N	Nozzle Size	No. of Ports	Inlet	Weight			
				gr	oz		
25.1370.00	-	10	1/2 Bsp F	310	11	1	
25.1370.20	20	10	1/2 Bsp F	327	11,53	1	✓
25.1370.30	30	10	1/2 Bsp F	330	11,64	1	
25.1375.30	30	10	3/4 Bsp F	845	29,81	1	
25.1375.40	40	10	3/4 Bsp F	845	29,81	1	
25.1380.50	50	10	1 Bsp F	820	28,92	1	
25.1380.70	70	10	1 Bsp F	810	28,5	1	

Rated Pressure 300 bar - 30 MPa 4350 psi
 Rated Temperature 160 °C 320 °F
 Material Stainless steel



RR-TF -SST. ROTATING DRAIN CLEANING -HEAD CUTTER

P/N	Nozzle Size	No. of Ports	Inlet	Weight			
				gr	oz		
25.1246.00	-	10	1/2 Bsp F	310	11	1	✓
25.1246.20	20	10	1/2 Bsp F	327	11,53	1	✓
25.1246.30	30	10	1/2 Bsp F	330	11,64	1	
25.1247.30	30	10	3/4 Bsp F	845	29,81	1	
25.1247.40	40	10	3/4 Bsp F	845	29,81	1	
25.1249.50	50	10	1 Bsp F	820	28,92	1	
25.1249.70	70	10	1 Bsp F	810	28,5	1	

Rated Pressure 300 bar - 30 MPa 4350 psi
 Rated Temperature 160 °C 320 °F
 Material Stainless steel



M27 × 2 - COUPLING TYPE "A+B"

P/N	Inlet	Couplings	Weight		
			gr	oz	
26.0450.00	1/4 Bsp F	A M27	84	2,96	10
26.0460.00	1/4 Bsp F	B M27	66	2,3	10

Rated Pressure	120 bar - 12 MPa	1750 psi
Permissible Pressure	130 bar - 13 MPa	1900 psi
Rated Flow	30 l/min	8 USGpm
Rated Temperature	60 °C	140 °F

Pin Ø14 mm



AR1 - "A" NIPPLE M22 - Ø14 MM - BSP

P/N	Inlet	Weight			
		gr	oz		
26.0029.31R	1/8 Bsp F	65	2,3	10	
26.0051.31R	1/4 Bsp M	46	1,62	25	✓
26.0002.31R	1/4 Bsp F	65	2,3	25	✓
26.0030.31R	3/8 Bsp M	53	1,87	25	✓
26.0031.31R	3/8 Bsp F	68	2,4	25	✓
26.0032.31R	1/2 Bsp M	61	2,15	25	✓
26.0033.31R	1/2 Bsp F	80	2,82	25	✓
26.0041.31R	A M21	65	2,3	10	✓
26.0005.31R	A M22	65	2,3	25	✓

Rated Pressure	250 bar - 25 MPa	3650 psi
Permissible Pressure	280 bar - 28 MPa	4050 psi
Rated Flow	40 l/min	10,5 USGpm
Rated Temperature	160 °C	320 °F

Pin Ø14 mm - M22×1,5 M



AR41 - "A" SST. NIPPLE M22 Ø14 MM - BSP

P/N	Inlet	Weight			
		gr	oz		
26.0235.51R	3/8 Bsp F	54	1,9	5	✓

Rated Pressure	250 bar - 25 MPa	3650 psi
Permissible Pressure	280 bar - 28 MPa	4050 psi
Rated Flow	40 l/min	10,5 USGpm
Rated Temperature	160 °C	320 °F
Material	Stainless steel 303	

Pin Ø14 mm - M22×1,5 M



AR1 - "B" COUPLER M22 2 PCS. - BSP

P/N	Inlet	Hand nut	Weight			
			gr	oz		
26.0150.05	1/8 Bsp F	AR1 type	70	2,4	10	
26.0150.30	1/4 Bsp M	AR1 type	66	2,33	25	✓
26.0150.20	1/4 Bsp F	AR1 type	68	2,4	25	✓
26.9952.98	1/4 Bsp F	AR4 type	73	2,57	25	✓
26.9954.98	1/4 Bsp F	Old type	70	2,4	25	
26.0150.40	3/8 Bsp M	AR1 type	72	2,54	25	✓

Rated Pressure	250 bar - 25 MPa	3650 psi
Permissible Pressure	280 bar - 28 MPa	4050 psi
Rated Flow	40 l/min	10,5 USGpm
Rated Temperature	160 °C	320 °F

Pin Ø14 mm - M22x1,5 F - non-revolving pin





AR1 - "B" COUPLER M22 2 PCS. ROTATING PIN - BSP

P/N	Inlet	Hand nut	Weight		5
			gr	oz	
26.0150.31	1/4 Bsp M	AR1 type	70	2,4	5
Rated Pressure	250 bar - 25 MPa		3650 psi		
Permissible Pressure	280 bar - 28 MPa		4050 psi		
Rated Flow	40 l/min		10,5 USGpm		
Rated Temperature	160 °C		320 °F		

Pin Ø14 mm - M22x1,5 F



AR1 - "B" COUPLER M22- 3 PCS.- BSP

P/N	Inlet	Weight		5	
		gr	oz		
26.0250.05	1/8 Bsp F	112	3,9	5	
26.0250.30	1/4 Bsp M	104	3,67	25	✓
26.0250.20	1/4 Bsp F	118	4,16	25	✓
26.0250.50	3/8 Bsp M	111	3,92	25	✓
26.0250.40	3/8 Bsp F	117	4,13	25	✓
26.0250.70	1/2 Bsp M	124	4,37	10	✓
26.0250.60	1/2 Bsp F	147	5,18	25	✓
Rated Pressure	250 bar - 25 MPa		3650 psi		
Permissible Pressure	280 bar - 28 MPa		4050 psi		
Rated Flow	40 l/min		10,5 USGpm		
Rated Temperature	160 °C		320 °F		

Pin Ø14 mm - M22x1,5 F - non-revolving pin



AR1 - "B" COUPLER M22- 3 PCS. ROTATING PIN - BSP

P/N	Inlet	Weight		5	
		gr	oz		
26.0250.31	1/4 Bsp M	100	3,53	5	✓
26.0250.21	1/4 Bsp F	114	4,02	5	✓
26.0250.51	3/8 Bsp M	106	3,74	5	✓
26.0250.41	3/8 Bsp F	114	4,02	5	✓
26.0250.71	1/2 Bsp M	120	4,2	5	
Rated Pressure	250 bar - 25 MPa		3650 psi		
Permissible Pressure	280 bar - 28 MPa		4050 psi		
Rated Flow	40 l/min		10,5 USGpm		
Rated Temperature	160 °C		320 °F		

Pin Ø14 mm - M22x1,5 F



AR41 - "B" SST. COUPLER M22- 3 PCS.- BSP

P/N	Inlet	Weight		5	
		gr	oz		
26.0230.40	3/8 Bsp F	125	4,41	5	
Rated Pressure	250 bar - 25 MPa		3650 psi		
Permissible Pressure	280 bar - 28 MPa		4050 psi		
Rated Flow	40 l/min		10,5 USGpm		
Rated Temperature	160 °C		320 °F		
Material	Stainless steel 303				

Pin Ø14 mm - M22x1,5 F



AR1 - "A" NIPPLE - 2×M22 - Ø14MM - WITH KNOB

P/N	Inlet	Weight		25	✓
		gr	oz		
26.0055.00	A 2× M22	176	6,21	25	✓
Rated Pressure	250 bar - 25 MPa	3650 psi			
Permissible Pressure	280 bar - 28 MPa	4050 psi			
Rated Flow	40 l/min	10,5 USGpm			
Rated Temperature	160 °C	320 °F			

Pin Ø14 mm - M22×1,5 M



AR1 - "A" NIPPLE M21- Ø14MM - BSP

P/N	Inlet	Weight		10	✓
		gr	oz		
26.0043.31R	1/8 Bsp F	65	2,3	10	
26.0044.31R	1/4 Bsp M	65	2,3	10	✓
26.0045.31R	1/4 Bsp F	56	1,98	10	✓
26.0046.31R	3/8 Bsp M	49	1,73	10	✓
26.0047.31R	3/8 Bsp F	65	2,3	10	✓
26.0049.31R	1/2 Bsp F	65	2,3	10	
26.0065.31R	M18 x 1,5 mm Ermeto	65	2,3	10	
26.0062.31R	M21 M	70	2,4	10	
Rated Pressure	250 bar - 25 MPa	3650 psi			
Permissible Pressure	280 bar - 28 MPa	4050 psi			
Rated Flow	40 l/min	10,5 USGpm			
Rated Temperature	160 °C	320 °F			

Pin Ø14 mm - M21×1,5 M



AR1 - "B" COUPLER M21 2 PCS. - BSP

P/N	Inlet	Weight		10	✓
		gr	oz		
26.0155.30	1/4 Bsp M	66	2,33	10	
Rated Pressure	250 bar - 25 MPa	3650 psi			
Permissible Pressure	280 bar - 28 MPa	4050 psi			
Rated Flow	40 l/min	10,5 USGpm			
Rated Temperature	160 °C	320 °F			

Pin Ø14 mm - M21×1,5 F



AR1 - "B" COUPLER M21- 3 PCS.- BSP



P/N	Inlet	Weight		25	✓
		gr	oz		
26.0270.30	1/4 Bsp M	104	3,67	25	✓
26.0270.20	1/4 Bsp F	118	4,16	25	✓
26.0270.50	3/8 Bsp M	110	3,88	25	✓
26.0270.40	3/8 Bsp F	118	4,16	25	✓
Rated Pressure	250 bar - 25 MPa	3650 psi			
Permissible Pressure	280 bar - 28 MPa	4050 psi			
Rated Flow	40 l/min	10,5 USGpm			
Rated Temperature	160 °C	320 °F			

Pin Ø14 mm - M21x1,5 F - non-revolving pin







AR1 - "B" COUPLER M21- 3 PCS. ROTATING PIN - BSP

P/N	Inlet	Weight			
		gr	oz		
26.0270.41	3/8 Bsp F	112	33,9	10	
Rated Pressure	250 bar - 25 MPa			3650 psi	
Permissible Pressure	280 bar - 28 MPa			4050 psi	
Rated Flow	40 l/min			10,5 USGpm	
Rated Temperature	160 °C			320 °F	

Pin Ø14 mm - M21×1,5 F





AR1 - "A" NIPPLE M22 - Ø14MM - NPT

P/N	Inlet	Weight			
		gr	oz		
26.0080.31R	1/4 Npt M	65	2,3	25	✓
26.0081.31R	1/4 Npt F	65	2,3	25	✓
26.0079.31R	3/8 Npt M	65	2,3	25	✓
26.0082.31R	3/8 Npt F	71	2,5	25	✓
26.0083.31R	1/2 Npt M	65	2,3	25	
Rated Pressure	250 bar - 25 MPa			3650 psi	
Permissible Pressure	280 bar - 28 MPa			4050 psi	
Rated Flow	40 l/min			10,5 USGpm	
Rated Temperature	160 °C			320 °F	

Pin Ø14 mm - M22×1,5 M





AR1 - "B" COUPLER M22- 3 PCS.- NPT

P/N	Inlet	Weight			
		gr	oz		
26.0240.30	1/4 Npt M	106	3,74	25	✓
26.0240.20	1/4 Npt F	117	4,13	25	✓
26.0240.50	3/8 Npt M	110	3,88	25	✓
26.0240.40	3/8 Npt F	118	4,16	25	✓
Rated Pressure	250 bar - 25 MPa			3650 psi	
Permissible Pressure	280 bar - 28 MPa			4050 psi	
Rated Flow	40 l/min			10,5 USGpm	
Rated Temperature	160 °C			320 °F	

Pin Ø14 mm - M22×1,5 F



AR1 - "A" NIPPLE 1/2 BSP M -Ø14 MM -BSP

P/N	Inlet	Mat.	Weight			
			gr	oz		
26.0122.31R	3/8 Bsp M	Brass	50	1,76	5	✓
Rated Pressure	250 bar - 25 MPa			3650 psi		
Permissible Pressure	280 bar - 28 MPa			4050 psi		
Rated Flow	40 l/min			10,5 USGpm		
Rated Temperature	160 °C			320 °F		

Pin Ø14 mm - 1/2 Bsp M



AR1 - "A" NIPPLE 1/2 BSP M - Ø15MM - BSP

P/N	Inlet	Mat.	Weight		
			gr	oz	
26.0113.31R	1/4 Bsp F	Brass	52	1,83	10
Rated Pressure		250 bar - 25 MPa			3650 psi
Permissible Pressure		280 bar - 28 MPa			4050 psi
Rated Flow		40 l/min			10,5 USGpm
Rated Temperature		160 °C			320 °F



Pin Ø15 mm - 1/2 Bsp M

AR1 - "B" COUPLER 1/2 BSP F 2 PCS. -BSP

P/N	Inlet	Weight		
		gr	oz	
26.0110.20	1/4 Bsp F	64	2,26	25
Rated Pressure		250 bar - 25 MPa		3650 psi
Permissible Pressure		280 bar - 28 MPa		4050 psi
Rated Flow		40 l/min		10,5 USGpm
Rated Temperature		160 °C		320 °F



Pin Ø15 mm - 1/2 Bsp F

AR1 - "B" COUPLER 2PCS M22 - Ø15MM - BSP

P/N	Inlet	Weight		
		gr	oz	
26.9152.98	1/4 Bsp F	64	2,3	5
Rated Pressure		250 bar - 25 MPa		3650 psi
Permissible Pressure		280 bar - 28 MPa		4050 psi
Rated Flow		40 l/min		10,5 USGpm
Rated Temperature		160 °C		320 °F



Pin Ø15 mm - M22×1,5 F

AR1 - "B" COUPLER M22 - 3 PCS. - Ø15MM -BSP

P/N	Inlet	Weight		
		gr	oz	
26.0281.00	M22	110	3,88	5
26.0281.40	3/8 Bsp F	126	4,44	10
26.0281.50	3/8 Bsp M	102	3,6	10
Rated Pressure		250 bar - 25 MPa		3650 psi
Permissible Pressure		280 bar - 28 MPa		4050 psi
Rated Flow		40 l/min		10,5 USGpm
Rated Temperature		160 °C		320 °F



Pin Ø15 mm - M22×1,5 F



AR5 - "A" EXTENDED NIPPLE TYPE M22-2 O-RINGS - BSP

P/N	Inlet	Weight		25	✓
		gr	oz		
26.1020.31R	1/4 Bsp M	59	2,08	25	✓
26.1032.31R	1/4 Bsp F	78	2,75	25	✓
26.1019.31R	3/8 Bsp M	80	2,8	25	✓
26.1037.31R	3/8 Bsp F	80	2,8	25	✓

Rated Pressure	250 bar - 25 MPa	3650 psi
Permissible Pressure	280 bar - 28 MPa	4050 psi
Rated Flow	40 l/min	10,5 USGpm
Rated Temperature	160 °C	320 °F



Pin Ø14 mm M22×1,5 M

AR5 - "B" EXTENDED COUPLER M22 2 PCS. 2 O-RINGS -BSP

P/N	Inlet	Type	Hand nut	Weight		25	✓
				gr	oz		
26.1029.00	1/4 Bsp M	Revolving	AR1 type	70	2,47	25	✓
Revolving connection							
26.1025.00	1/4 Bsp M	Revolving	AR1 type	66	2,33	10	✓
Revolving connection -sst piston							
26.1028.00	1/4 Bsp F	Fixed	AR1 type	74	2,61	25	
26.9950.98	1/4 Bsp F	Fixed	AR4 type	90	3,1	25	✓
26.1035.00	3/8 Bsp M	Fixed	AR1 type	82	2,89	25	

Rated Pressure	250 bar - 25 MPa	3650 psi
Permissible Pressure	280 bar - 28 MPa	4050 psi
Rated Flow	40 l/min	10,5 USGpm
Rated Temperature	160 °C	320 °F
Material		Brass



Pin Ø14 mm - M22×1,5 F

AR5 - "B" EXTENDED COUPLER M22 - 3PCS. 2 O-RINGS - BSP



P/N	Inlet	Type	Weight		25	✓
			gr	oz		
26.1034.50	1/4 Bsp M	Revolving	108	3,81	25	✓
26.1034.20	1/4 Bsp F	Revolving	121	4,27	25	✓
26.1034.00	3/8 Bsp M	Revolving	115	4,06	25	✓
26.1033.00	3/8 Bsp F	Revolving	130	4,6	25	✓

Rated Pressure	250 bar - 25 MPa	3650 psi
Permissible Pressure	280 bar - 28 MPa	4050 psi
Rated Flow	40 l/min	10,5 USGpm
Rated Temperature	160 °C	320 °F



Revolving pin Ø14 mm- M22×1,5 F

AR4 - COUPLER M22 +HEXAGONAL JOINT - BSP



P/N	Type	Inlet	Weight				
			gr	oz			
26.0220.00	B 2 pcs	1/4 Bsp F	80	2,82	25	✓	
26.0225.31R	A	1/4 Bsp F	70	2,4	25	✓	
26.0199.31R	A1	1/4 Bsp M	70	2,4	10	✓	
10.3185.00R	C	Nbr	0,5	0,02	10	✓	

Rated Pressure	250 bar - 25 MPa	3650 psi
Permissible Pressure	280 bar - 28 MPa	4050 psi
Rated Flow	40 l/min	10,5 USGpm
Rated Temperature	160 °C	320 °F

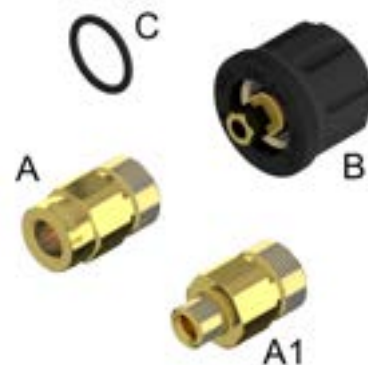
Pin Ø14 mm - M22×1,5 F with hexagonal joint and external O-ring to prevent unscrewing



AR3 - COUPLER M22 +HEXAGONAL JOINT - BSP



P/N	Type	Inlet	Weight				
			gr	oz			
26.0205.00	B 2 pcs	1/4 Bsp F	74	2,61	25	✓	
26.0199.31R	A	1/4 Bsp M	70	2,4	10	✓	
26.0200.31R	A	1/4 Bsp F	74	2,61	25	✓	

Rated Pressure	250 bar - 25 MPa	3650 psi
Permissible Pressure	280 bar - 28 MPa	4050 psi
Rated Flow	40 l/min	10,5 USGpm
Rated Temperature	160 °C	320 °F

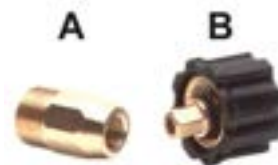
Pin Ø14 mm - M22×1,5 F with hexagonal joint



AR3/23 - COUPLER M22 + HEXAGONAL JOINT - BSP



P/N	Type	Inlet	Weight				
			gr	oz			
26.0210.00	B 2 pcs	1/4 Bsp F	108	3,81	5	✓	
26.0199.31R	A	1/4 Bsp M	70	2,4	10	✓	
26.0200.31R	A	1/4 Bsp F	70	2,4	25	✓	

Rated Pressure	250 bar - 25 MPa	3650 psi
Permissible Pressure	280 bar - 28 MPa	4050 psi
Rated Flow	40 l/min	10,5 USGpm
Rated Temperature	160 °C	320 °F

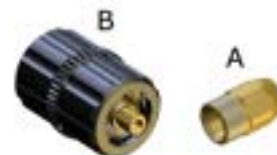
Pin Ø14 mm - M22×1,5 F with hexagonal joint



ARG - REVOLVING COUPLER TYPE "B" M22 - 1 O-RING

P/N	Inlet	Type	Weight				
			gr	oz			
26.0900.00	1/4 Bsp M	B 2 pcs	133	4,69	15	✓	
26.0910.00	A M22	B 3 pcs	192	6,77	15	✓	

Rated Pressure	250 bar - 25 MPa	3650 psi
Permissible Pressure	280 bar - 28 MPa	4050 psi
Rated Flow	40 l/min	10,5 USGpm
Rated Temperature	160 °C	320 °F

Pin Ø14 mm - M22×1,5 F - revolving even under pressure - suitable for connecting spray gun and lance





AR7 - "A" NIPPLE 1/2 BSP M - BSP

P/N	Inlet	Hole size		Weight		✓	✓
		mm	in	gr	oz		
26.0700.30	1/4 Bsp M	11	0,433	55	1,9	25	✓
26.0700.20	1/4 Bsp F	11	0,433	71	2,5	25	✓
26.0700.50	3/8 Bsp M	11	0,433	62	2,19	25	✓
26.0700.40	3/8 Bsp F	11	0,433	72	2,54	25	✓

Rated Pressure 250 bar - 25 MPa 3650 psi
 Permissible Pressure 280 bar - 28 MPa 4050 psi
 Rated Flow 40 l/min 10,5 USGpm
 Rated Temperature 160 °C 320 °F



Pin Ø11mm

AR7 - "B" COUPLER 1/2 BSP F - 3 PCS. - BSP

P/N	Inlet	Hole size		Weight		✓	✓
		mm	in	gr	oz		
26.0750.30	1/4 Bsp M	11	0,433	93	3,3	25	✓
26.0750.20	1/4 Bsp F	11	0,433	99	3,49	25	✓
26.0750.50	3/8 Bsp M	11	0,433	100	3,53	25	✓
26.0750.40	3/8 Bsp F	11	0,433	110	3,9	25	✓

Rated Pressure 250 bar - 25 MPa 3650 psi
 Permissible Pressure 280 bar - 28 MPa 4050 psi
 Rated Flow 40 l/min 10,5 USGpm
 Rated Temperature 160 °C 320 °F



Pin Ø11mm

AR8- COUPLER 350 BAR M24 - 2 O-RINGS - BSP

P/N	Inlet	Type	Weight		✓	✓
			gr	oz		
26.0630.20	1/4 Bsp F	A	96	3,39	10	✓
26.0630.40	3/8 Bsp F	A	88	3,1	10	✓
26.0630.50	3/8 Bsp M	A	76	2,68	10	✓
26.0615.20	1/4 Bsp F	B 2 pcs	88	3,1	5	✓

Coupling for outlet spray gun.

26.0650.30	1/4 Bsp M	B 3 pcs	126	4,44	10	✓
26.0650.50	3/8 Bsp M	B 3 pcs	135	4,76	10	✓

Rated Pressure 350 bar - 35 MPa 5100 psi
 Permissible Pressure 390 bar - 39 MPa 5650 psi
 Rated Flow 30 l/min 8 USGpm
 Rated Temperature 160 °C 320 °F



Pin Ø14 mm - M24×1,5 F

AR200- COUPLER 350 BAR M30 - 2 O-RINGS - BSP

P/N	Inlet	Type	Weight		✓	✓
			gr	oz		
26.0840.60	3/4 Bsp F	A	147	5,2	2	✓
26.0850.60	3/4 Bsp F	B 3 pcs	410	14,5	2	✓

Rated Pressure 350 bar - 35 MPa 5100 psi
 Permissible Pressure 390 bar - 39 MPa 5650 psi
 Rated Flow 200 l/min 53 USGpm
 Rated Temperature 60 °C 140 °F



Pin Ø21,5 mm - M30×1,5 F

AR9 - COUPLER 600 BAR M24 - 2 O-RINGS - BSP

P/N	Inlet	Type	Weight		10	✓
			gr	oz		
26.0940.40	3/8 Bsp F	A	82	2,89	10	✓
26.0940.50	3/8 Bsp M	A	71	2,5	10	✓
26.0940.70	1/2 Bsp M	A	74	2,61	10	✓
26.0940.80	M24 M	A	87	3,07	10	
26.0950.40	3/8 Bsp F	B 3 pcs	145	5,1	10	✓
26.0950.30	1/4 Bsp M	B 3 pcs	136	4,8	10	✓
26.0950.50	3/8 Bsp M	B 3 pcs	142	5	10	✓
26.0950.70	1/2 Bsp M	B 3 pcs	145	5,1	10	✓

Rated Pressure 600 bar - 60 MPa 8700 psi
 Permissible Pressure 660 bar - 66 MPa 9500 psi
 Rated Flow 80 l/min 21 USGpm
 Rated Temperature 160 °C 320 °F
 Material Stainless steel

Pin Ø15 mm - M24x1,5 F



BAYONET COUPLING - 14 MM

P/N	Inlet	Type	Weight		10	✓
			gr	oz		
26.0605.00	1/4 Bsp F	A	42	1,48	10	✓
26.0604.31R	1/4 Bspt M taper 60°	B	84	2,96	10	✓

Rated Pressure 120 bar - 12 MPa 1750 psi
 Permissible Pressure 140 bar - 14 MPa 2000 psi
 Rated Flow 30 l/min 8 USGpm
 Rated Temperature 90 °C 195 °F
 Material Brass

Pin Ø14 mm



BAYONET COUPLING - 14 MM

P/N	Inlet	Type	Weight		10	✓
			gr	oz		
26.0590.00	1/4 Bsp F	A	50	1,76	10	✓

Rated Pressure 160 bar - 16 MPa 2300 psi
 Permissible Pressure 180 bar - 18 MPa 2600 psi
 Rated Flow 30 l/min 8 USGpm
 Rated Temperature 90 °C 195 °F
 Material Brass

Pin Ø14 mm



BAYONET COUPLING - 8 MM

P/N	Inlet	Weight		10	✓
		gr	oz		
26.0606.00	1/4 Bsp F	100	3,53	10	✓
26.0610.00	1/4 Bspt M	116	4,09	10	✓

Rated Pressure 250 bar - 25 MPa 3650 psi
 Permissible Pressure 280 bar - 28 MPa 4050 psi
 Rated Flow 30 l/min 8 USGpm
 Rated Temperature 90 °C 195 °F
 Material Brass

Pin Ø 8 mm





Ball-type quick couplings

ARS 178 L - BALL-TYPE QUICK COUPLING 12,5 MPA -SST

P/N	Inlet	Type	Weight		5	✓
			gr	oz		
26.2500.10	3/8 Bsp F	B	105	3,7	5	✓
26.2500.30	1/2 Bsp F	B	132	4,66	5	✓
26.2500.40	1/2 Bsp M	B	140	4,94	5	✓
26.2530.00	1/4 Bsp F	A	50	1,7	5	✓
26.2530.10	3/8 Bsp F	A	50	1,7	5	✓
26.2530.30	1/2 Bsp F	A	86	3,03	5	✓
26.2530.40	1/2 Bsp M	A	50	1,7	5	✓
Rated Pressure	125 bar - 12,5 MPa		1825 psi			
Permissible Pressure	140 bar - 14 MPa		2025 psi			
Rated Flow	50 l/min		13,2 USGpm			
Rated Temperature	90 °C		195 °F			
Material	Stainless steel					

Pin Ø17,8 mm - Internal hole Ø12 mm



ARS 220 - BALL-TYPE QUICK COUPLING 220 BAR

P/N	Inlet	Type	Weight		25	✓
			gr	oz		
26.2030.20	1/4 Bsp F	B	184	6,49	25	
26.2030.25	1/4 Bsp M	B	196	6,91	25	
26.2030.00	3/8 Bsp F	B	173	6,12	25	✓
26.2030.80	M 22 F	B	156	5,5	25	✓
26.2040.61R	1/4 Bsp F	A	69	2,43	25	✓
26.2045.61R	1/4 Bsp M	A	60	2,12	25	
26.2035.61R	3/8 Bsp F	A	58	2,05	25	✓
Rated Pressure	220 bar - 22 MPa		3200 psi			
Permissible Pressure	250 bar - 25 MPa		3650 psi			
Rated Flow	50 l/min		13,2 USGpm			
Rated Temperature	90 °C		195 °F			

Pin Ø19,9 mm - Internal hole Ø12 mm - Compatible with ARS350





ARS 178 - BALL-TYPE QUICK COUPLING 25 MPA -SST

P/N	Inlet	Type	Weight		5	✓
			gr	oz		
26.2500.10	3/8 Bsp F	B	105	3,7	5	✓
26.2500.30	1/2 Bsp F	B	132	4,66	5	✓
26.2500.40	1/2 Bsp M	B	140	4,94	5	✓
26.2520.00R	1/4 Bsp F	A	47	1,66	5	✓
26.2520.10R	3/8 Bsp F	A	50	1,7	5	✓
26.2520.30R	1/2 Bsp F	A	87	3,07	5	✓
26.2520.40R	1/2 Bsp M	A	60	2,12	5	✓
Rated Pressure	250 bar - 25 MPa		3650 psi			
Permissible Pressure	280 bar - 28 MPa		4050 psi			
Rated Flow	50 l/min		13,2 USGpm			
Rated Temperature	90 °C		195 °F			
Material	Stainless steel					

Pin in hardened stainless steel Ø17,8 mm - Internal hole Ø12 mm













ARS 178 P - BALL-TYPE QUICK COUPLING 25 MPA -SST

P/N	Inlet	Type	Weight		5	
			gr	oz		
26.2555.30	1/2 Bsp F	B	154	5,43	5	
26.2555.40	1/2 Bsp M	B	164	5,78	5	
Rated Pressure	250 bar - 25 MPa				3650 psi	
Permissible Pressure	280 bar - 28 MPa				4050 psi	
Rated Flow	50 l/min				13,2 USGpm	
Rated Temperature	90 °C				195 °F	
Material					Stainless steel	
Casing colour					Blue	

Pin in hardened stainless steel Ø17,8 mm - Internal hole Ø12 mm







ARS 250 - BALL-TYPE QUICK COUPLING 250 BAR

P/N	Inlet	Type	Weight		25	
			gr	oz		
26.2010.20	1/4 Bsp F	B	114	4,02	25	
26.2010.00	3/8 Bsp M	B	101	3,56	25	
26.2010.10	3/8 Bsp F	B	118	4,16	25	
26.2010.40	1/2 Bsp M	B	114	4,02	25	
26.2010.30	1/2 Bsp F	B	123	4,34	25	
26.2016.61R	1/4 Bsp F	A	45	1,59	25	
26.2023.61R	3/8 Bsp M	A	44	1,55	25	
26.2015.61R	3/8 Bsp F	A	50	1,7	25	
26.2024.61R	1/2 Bsp M	A	52	1,83	25	
Rated Pressure	250 bar - 25 MPa				3650 psi	
Permissible Pressure	280 bar - 28 MPa				4050 psi	
Rated Flow	30 l/min				8 USGpm	
Rated Temperature	90 °C				195 °F	

Pin Ø15 mm - Internal hole Ø8,5 mm



ARS 23 - SST BALL-TYPE QUICK COUPLING

P/N	Inlet	Type	Weight		5	
			gr	oz		
26.2300.00	1/4 Bsp F	B	278	9,81	5	
26.2350.51R	1/4 Bsp F	A	116	4,1	5	
26.2360.51R	1/4 Bsp M	A	115	4,1	5	
Rated Pressure	250 bar - 25 MPa				3650 psi	
Permissible Pressure	280 bar - 28 MPa				4050 psi	
Rated Flow	40 l/min				10,5 USGpm	
Rated Temperature	160 °C				320 °F	
Material					Stainless steel	

Pin Ø14 mm - Internal hole Ø8 mm





ARS 25 -BALL-TYPE QUICK COUPLING - KW

P/N	Inlet	Type	Mat.	Weight		5	
				gr	oz		
26.2400.00	1/4 Bsp F	B	Sst.+ brass	290	10,23	5	
26.2400.60	1/4 Bsp M	B1	Sst.+ brass	270	9,52	5	✓
26.2450.51R	1/4 Bsp F	A	St. steel	68	2,4	5	
26.2453.51R	1/4 Bsp M	A1	St. steel	82	2,89	5	✓
26.2451.51R	1/4 Bsp F x R5	A2	St. steel	74	2,61	5	✓

Rated Pressure	250 bar - 25 MPa	3650 psi
Permissible Pressure	280 bar - 28 MPa	4050 psi
Rated Flow	40 l/min	10,5 USGpm
Rated Temperature	160 °C	320 °F

Pin Ø12 mm (0,47") - Internal hole Ø7 mm (0,28")



ARS 25 P -BALL-TYPE QUICK COUPLING - KW

P/N	Inlet	Type	Mat.	Weight		5	
				gr	oz		
26.2410.60	1/4 Bsp M	B	Brass	232	8,18	5	✓
Rated pr. 250bar – 25MPa – 3650psi Permiss.press. 280bar – 28MPa – 4050psi							
26.2415.60	1/4 Bsp M	B1	Sst.+ brass	232	8,18	5	
Rated pr. 250bar – 25MPa – 3650psi Permiss.press. 280bar – 28MPa – 4050psi							

26.2440.60	1/4 Bsp M	B2	St. steel	216	7,62	5	✓
Rated pr. 310bar – 31MPa – 4500psi Permiss.press. 350bar – 35MPa – 5100psi							

26.2450.51R	1/4 Bsp F	A	St. steel	68	2,4	5	
Rated pr. 310bar – 31MPa – 4500psi Permiss.press. 350bar – 35MPa – 5100psi							

26.2451.51R	1/4 Bsp F x R5	A1	St. steel	68	2,4	5	✓
Rated pr. 310bar – 31MPa – 4500psi Permiss.press. 350bar – 35MPa – 5100psi							

Rated Flow	40 l/min	10,5 USGpm
Rated Temperature	160 °C	320 °F

Pin Ø12 mm (0,47") - Internal hole Ø7 mm (0,28")



ARSU - BALL-TYPE QUICK COUPLING FOR "Q-STYLE"-NOZZLE



P/N	Inlet	Hole size		Weight		25	
		mm	in	gr	oz		
26.2060.00	1/4 Npt F	12	0,47	68	2,4	25	✓

Rated Pressure	310 bar - 31 MPa	4500 psi
Permissible Pressure	350 bar - 35 MPa	5000 psi
Rated Flow	40 l/min	10,5 USGpm
Rated Temperature	160 °C	320 °F

Pin Ø12 mm



ARS250-35MPA-SST BALL-TYPE QUICK COUPLING 35MPA

P/N	Inlet	Type	Weight			
			gr	oz		
26.2005.00	3/8 Bsp M	B	101	3,56	25	
26.2005.10	3/8 Bsp F	B1	118	4,16	25	
26.2006.51R	3/8 Bsp M	A	44	1,55	25	
26.2007.51R	3/8 Bsp F	A1	50	1,7	25	

Rated Pressure	350 bar - 35 MPa	5100 psi
Permissible Pressure	390 bar - 39 MPa	5650 psi
Rated Flow	30 l/min	8 USGpm
Rated Temperature	90 °C	195 °F
Material	Stainless steel	

Pin Ø15 mm - Internal hole Ø8,5 mm



ARS 350 -STAINLESS STEEL BALL-TYPE QUICK COUPLING 350 BAR



P/N	Inlet	Type	Mat.	Weight			
				gr	oz		
26.2045.51R	1/4 Bsp M	A	St. steel	59	2,08	25	✓
26.2040.51R	1/4 Bsp F	A	St. steel	68	2,4	25	✓
26.2048.51R	3/8 Bsp M	A	St. steel	74	2,61	25	✓
26.2035.51R	3/8 Bsp F	A	St. steel	57	2,01	25	✓
26.2050.20	1/4 Bsp F	B	St. steel	166	5,85	25	✓
26.2050.25	1/4 Bsp M	B	St. steel	158	5,59	25	✓
26.2050.00	3/8 Bsp F	B	St. steel	158	5,57	25	✓

Rated Pressure	350 bar - 35 MPa	5100 psi
Permissible Pressure	390 bar - 39 MPa	5650 psi
Rated Flow	50 l/min	13,2 USGpm
Rated Temperature	90 °C	195 °F

Pin Ø19,9 mm - Internal hole Ø12 mm - Compatible with ARS220



ARS 350 P -STAINLESS STEEL BALL-TYPE QUICK COUPLING 35MPA

P/N	Inlet	Type	Mat.	Weight			
				gr	oz		
26.2055.25	1/4 Bsp M	B	St. steel	192	6,77	25	✓

Rated Pressure	350 bar - 35 MPa	5100 psi
Permissible Pressure	390 bar - 39 MPa	5650 psi
Rated Flow	50 l/min	13,2 USGpm
Rated Temperature	90 °C	195 °F
Casing colour	Black	

Pin Ø19,9 mm - Internal hole Ø12 mm





SW65 - LARGE FLOW BALL SWIVEL

P/N	Inlet	Outlet	Weight		10	15
			gr	oz		
30.6480.00	1/2 Bsp F	1/2 Bsp M	120	4,23	5	✓
Rated Pressure	24 bar - 2,4 MPa				350 psi	
Rated Flow	100 l/min				26,5 USGpm	
Rated Temperature	100 °C				212 °F	
Max. working temperature	90 °C				194 °F	
Max. RPM					30 giri/min	
Material					Brass	



SW5- LARGE FLOW SWIVEL

P/N	Inlet	Outlet	Mat.	Weight		10	15
				gr	oz		
26.1070.00	1/2 Bsp M	1/2 Bsp F	Sst Ai 303	102	3,6	10	✓
26.1076.00	1/2 Bsp M	1/2 Bsp F	Sst Ai 316L	102	3,6	5	✓
26.1080.00	1/2 Bsp M	1/2 Bsp F	Brass	117	4,13	10	✓
Rated Pressure	200 bar - 20 MPa				2900 psi		
Permissible Pressure	220 bar - 22 MPa				3200 psi		
Rated Flow	160 l/min				42 USGpm		
Rated Temperature	90 °C				194 °F		
Max. temperature for short	160 °C				320 °F		



LR - LIGHT DUTY SWIVEL

P/N	Inlet	Outlet	Weight		10	15
			gr	oz		
26.1000.00	3/8 Bsp M	3/8 Bsp F	75	2,65	10	✓
26.1000.05	3/8 Bsp M	1/4 Bsp F	82	2,89	10	✓
26.1000.10	3/8 Npt M	3/8 Npt F	76	2,6	10	✓
Rated Pressure	220 bar - 22 MPa				3200 psi	
Permissible Pressure	250 bar - 25 MPa				3650 psi	
Rated Flow	30 l/min				8 USGpm	
Rated Temperature	90 °C				195 °F	
Max. working temperature	60 °C				140 °F	
Material					Brass	





MR-O - BRASS SWIVEL

P/N	Inlet	Outlet	Weight		10	15
			gr	oz		
26.1040.00	1/4 Bspt M taper 60°	1/4 Bsp F	173	6,1	10	✓
26.1050.00	3/8Bspt M taper 60°	3/8 Bsp F	173	6,1	10	✓
26.1055.00	1/2 Bsp M	1/2 Bsp F	216	7,62	10	✓
Rated Pressure	250 bar - 25 MPa				3650 psi	
Permissible Pressure	280 bar - 28 MPa				4050 psi	
Rated Flow	40 l/min				10,5 USGpm	
Rated Temperature	160 °C				320 °F	
Max. working temperature	90 °C				194 °F	
Material					Brass	



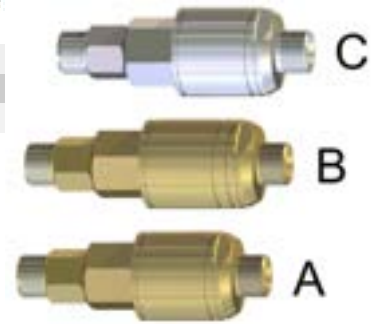

SWIVEL FOR HIGH PRESSURE HOSE REEL -SST/BRASS

P/N	Type	Fitting	Inlet	Outlet	Material	Weight			
						gr	oz		
26.1100.20	A	2 seeger	3/8 Bsp M	3/8 Bsp M	Brass	386	13,62	5	✓
26.1100.30	B	3 seeger	3/8 Bsp M	3/8 Bsp M	Brass	386	13,62	5	
26.1150.00	C	2 seeger	3/8 Bsp M	3/8 Bsp M	Stainless steel 303	386	13,62	3	
Rated Pressure		250 bar - 25 MPa		3650 psi					
Permissible Pressure		280 bar - 28 MPa		4050 psi					
Rated Flow		40 l/min		10,5 USGpm					
Rated Temperature		160 °C		320 °F					
Max. working temperature		90 °C		194 °F					





SW25 - SST. BALL BEARING SWIVEL

P/N	Inlet	Outlet	Weight				
			gr	oz			
26.1200.20	1/4 Bsp M	1/4 Bsp F	147	5,18	5	✓	
26.1200.42	1/4 Bsp M	3/8 Bsp F	155	5,5	5	✓	
26.1200.22	3/8 Bsp M	1/4 Bsp F	146	5,15	5	✓	
26.1200.40	3/8 Bsp M	3/8 Bsp F	155	5,5	5	✓	
26.1200.45	3/8 Bsp F	3/8 Bsp F	198	6,98	5	✓	
26.1200.28	3/8 Bsp F	1/4 Bsp F	190	6,7	5	✓	
Rated Pressure		250 bar - 25 MPa		3650 psi			
Permissible Pressure		280 bar - 28 MPa		4050 psi			
Rated Flow		40 l/min		10,5 USGpm			
Rated Temperature		120 °C		250 °F			
Max. working temperature		90 °C		194 °F			
Max. RPM				30 giri/min			
Material				Sst.+ nick.pl. brass			



SW25-E - SST. BALL BEARING SWIVEL

P/N	Inlet	Outlet	Weight				
			gr	oz			
26.1250.20	1/4 Bsp M	1/4 Bsp F	148	5,22	5		
26.1250.40	3/8 Bsp M	3/8 Bsp F	155	5,5	5	✓	
Rated Pressure		250 bar - 25 MPa		3650 psi			
Permissible Pressure		280 bar - 28 MPa		4050 psi			
Rated Flow		40 l/min		10,5 USGpm			
Rated Temperature		120 °C		250 °F			
Max. working temperature		90 °C		194 °F			
Max. RPM				30 giri/min			
Material				Sst.+ nick.pl. brass			
Seals material				Epdm			



Sturdy construction in nickel-plated brass and stainless steel, with compact dimensions with high performance.

EPDM seals ensure chemical compatibility of the swivels with detergents which can damage standard Viton seals.



SW90 - 90° SWIVEL

P/N	Inlet	Outlet	Weight		5	✓
			gr	oz		
26.1300.20	1/4 Bsp M	1/4 Bsp F	195	7	5	✓
26.1300.40	3/8 Bsp M	3/8 Bsp F	187	6,6	5	✓
26.1300.42	3/8 Bsp M	1/4 Bsp F	198	6,98	5	
Rated Pressure	250 bar - 25 MPa		3650 psi			
Permissible Pressure	280 bar - 28 MPa		4050 psi			
Rated Flow	40 l/min		10,5 USGpm			
Rated Temperature	160 °C		320 °F			
Max. working temperature	90 °C		194 °F			
Max. RPM			30 giri/min			
Screw material			Stainless steel			



SW90- E - 90° SWIVEL EPDM

P/N	Inlet	Outlet	Weight		5	✓
			gr	oz		
26.1350.20	1/4 Bsp M	1/4 Bsp F	195	7	5	✓
Rated Pressure	250 bar - 25 MPa		3650 psi			
Permissible Pressure	280 bar - 28 MPa		4050 psi			
Rated Flow	40 l/min		10,5 USGpm			
Rated Temperature	160 °C		320 °F			
Max. working temperature	90 °C		194 °F			
Max. RPM			30 giri/min			
Screw material			Stainless steel			
Seals material			Epdm			



Sturdy construction in nickel-plated brass and stainless steel, with compact dimensions with high performance.
EPDM seals ensure chemical compatibility of the swivels with detergents which can damage standard Viton seals.

MR-I - STAINLESS STEEL SWIVEL

P/N	Inlet	Outlet	Weight		10	✓
			gr	oz		
26.1060.00	1/4 Bspt M taper 60°	1/4 Bsp F	162	5,71	10	✓
26.1061.00	3/8Bspt M taper 60°	3/8 Bsp F	160	5,64	10	✓
26.1060.50	1/4 Npt M	1/4 Npt F	168	5,93	10	✓
26.1061.50	3/8 Npt M	3/8 Npt F	166	5,85	10	✓
26.1062.00	3/8Bspt M taper 60°	1/4 Bsp F	168	5,93	10	
Rated Pressure	350 bar - 35 MPa		5100 psi			
Permissible Pressure	390 bar - 39 MPa		5650 psi			
Rated Flow	40 l/min		10,5 USGpm			
Rated Temperature	160 °C		320 °F			
Max. working temperature	90 °C		194 °F			
Max. RPM			30 giri/min			
Material			Stainless steel			



SW35 - SST. BALL BEARING SWIVEL

P/N	Inlet	Outlet	Weight			
			gr	oz		
26.1412.40	3/8 Bsp M	3/8 Bsp F	489	17,25	1	✓
26.1412.43	3/8 Bsp M	3/8 Bsp M	461	16,26	1	✓
26.1412.45	3/8 Bsp F	3/8 Bsp F	585	20,64	1	✓
26.1412.48	3/8 Bsp F	3/8 Bsp M	544	19,19	1	✓

Rated Pressure	350 bar - 35 MPa	5100 psi
Permissible Pressure	390 bar - 39 MPa	5650 psi
Rated Flow	40 l/min	10,5 USGpm
Rated Temperature	120 °C	250 °F
Max. working temperature	90 °C	194 °F
Max. RPM		2000 giri/min
Material	Sst.+ nick.pl. brass	



SW90 - 90° STAINLESS STEEL SWIVEL

P/N	Inlet	Outlet	Weight			
			gr	oz		
26.1320.00	1/2 Bsp M	1/2 Bsp F	437	15,41	5	✓

Rated Pressure	350 bar - 35 MPa	5100 psi
Permissible Pressure	390 bar - 39 MPa	5650 psi
Rated Flow	80 l/min	21 USGpm
Rated Temperature	160 °C	320 °F
Max. working temperature	90 °C	194 °F
Max. RPM		30 giri/min
Material	Stainless steel	



SW 600 -660 BAR- STAINLESS STEEL SWIVEL

P/N	Inlet	Outlet	Weight			
			gr	oz		
30.5840.00	3/8 Bsp F	3/8 Bsp M	400	14,11	1	

Rated Pressure	600 bar - 60 MPa	8700 psi
Permissible Pressure	660 bar - 66 MPa	9570 psi
Rated Flow	60 l/min	15,8 USGpm
Rated Temperature	100 °C	212 °F
Max. working temperature	90 °C	194 °F
Max. RPM		30 giri/min
Material	Stainless steel	



SW90-600 - 90° STAINLESS STEEL SWIVEL

P/N	Inlet	Outlet	Weight			
			gr	oz		
26.1330.00	1/2 Bsp M	1/2 Bsp F	636	22,43	2	✓

Rated Pressure	600 bar - 60 MPa	8700 psi
Permissible Pressure	660 bar - 66 MPa	9570 psi
Rated Flow	80 l/min	21 USGpm
Max. working temperature	90 °C	194 °F
Max. RPM		30 giri/min
Material	Stainless steel	





FOAM INJECTOR

P/N	Inlet	Outlet	Nozzle		Weight		5	
			mm	gr	oz			
21.0800.25	1/4 Bsp F	1/4 Bspt M	2,5	49	1,73	5		
Rated Pressure	120 bar - 12 MPa		1750 psi					
Rated Flow	40 l/min		10,5 USGpm					
Material	Stainless steel 303							



EXTENDED CHEMICAL INJECTOR 3/8 BSP MM

P/N	Nozzle	Col.	Hose barb		Weight		5	
			mm	in	gr	oz		
21.0600.12	1,2	Black	7	0,27	314	11,07	5	
21.0600.14	1,4	Red	7	0,27	315	11,11	5	
21.0600.18	1,8	Blue	7	0,27	315	11,11	5	
21.0600.21	2,1	Blue	7	0,27	300	10,6	5	
Rated Pressure	220 bar - 22 MPa		3200 psi					
Permissible Pressure	250 bar - 25 MPa		3650 psi					
Rated Flow	30 l/min		8 USGpm					
Rated Temperature	90 °C		195 °F					
Inlet	3/8 Bsp M							
Outlet	3/8 Bsp M							
Material	Brass							
Type	Adjust.							



Injector with high suction power

CHEMICAL INJECTOR 3/8 BSP MM

P/N	Type	Nozzle		Hose barb		Weight		15	
		mm	mm	in	gr	oz			
21.0000.00	Fixed	0	7	0,27	136	4,8	15		
21.0000.18	Fixed	1,8	7	0,27	140	4,9	15		
21.0000.21	Fixed	2,1	7	0,27	140	4,9	15		
21.0000.23	Fixed	2,3	7	0,27	140	4,9	15		
21.0000.25	Fixed	2,5	7	0,27	140	4,9	15		
21.0150.02	Adjust.	0	7	0,27	160	5,64	15		
21.0150.18	Adjust.	1,8	7	0,27	162	5,71	15		
21.0150.21	Adjust.	2,1	7	0,27	162	5,71	15		
21.0150.23	Adjust.	2,3	7	0,27	162	5,71	15		
Rated Pressure	280 bar - 28 MPa		4050 psi						
Permissible Pressure	310 bar - 31 MPa		4500 psi						
Rated Flow	30 l/min		8 USGpm						
Rated Temperature	90 °C		195 °F						
Inlet	3/8 Bsp M								
Outlet	3/8 Bsp M								



CHEMICAL INJECTOR 3/8 BST-P MM-H.BARB SW.

P/N	Type	Nozzle		Hose barb		Weight		15	
		mm	mm	in	gr	oz			
21.0080.21	(A) Fixed	2,1	7	0,27	155	5,47	15		
21.0130.21	(B) Adjust.	2,1	7	0,27	160	5,64	12		
Rated Pressure	280 bar - 28 MPa		4050 psi						
Permissible Pressure	310 bar - 31 MPa		4500 psi						
Rated Flow	30 l/min		8 USGpm						
Rated Temperature	90 °C		195 °F						
Inlet	3/8 Bspt M								
Outlet	3/8 Bsp M								

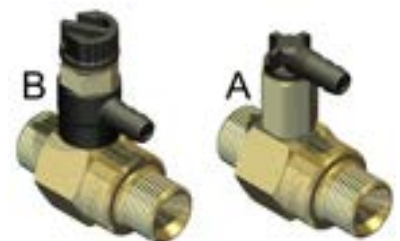

CHEMICAL INJECTOR 3/8NPT MM

P/N	Type	Nozzle		Hose barb		Weight				
		mm	mm	in	gr	oz				
21.0012.18	Fixed	1,8	7	0,27	140	4,9	15			✓
21.0012.21	Fixed	2,1	7	0,27	142	5,01	15			✓
21.0012.23	Fixed	2,3	7	0,27	140	4,9	15			✓
21.0154.15	Adjust.	1,5	7	0,27	164	5,78	15			
21.0154.18	Adjust.	1,8	7	0,27	164	5,78	15			✓
21.0154.21	Adjust.	2,1	7	0,27	164	5,78	15			✓
21.0154.23	Adjust.	2,3	7	0,27	164	5,78	15			✓

Rated Pressure 280 bar - 28 MPa 4050 psi
 Permissible Pressure 310 bar - 31 MPa 4500 psi
 Rated Flow 30 l/min 8 USGpm
 Rated Temperature 90 °C 195 °F
 Inlet 3/8 Npt M
 Outlet 3/8 Npt M



CHEMICAL INJECTOR 3/8NPT MM EPDM O-RING

P/N	Type	Nozzle		Hose barb		Weight				
		mm	mm	in	gr	oz				
21.0145.18	Adjust.	1,8	7	0,27	164	5,78	15			
21.0145.21	Adjust.	2,1	7	0,27	164	5,78	15			
21.0145.23	Adjust.	2,3	7	0,27	164	5,78	15			

Rated Pressure 280 bar - 28 MPa 4050 psi
 Permissible Pressure 310 bar - 31 MPa 4500 psi
 Rated Flow 30 l/min 8 USGpm
 Rated Temperature 90 °C 195 °F
 Inlet 3/8 Npt M
 Outlet 3/8 Npt M

Epdm O-rings



CHEMICAL INJECTOR 3/8 BSP FM

P/N	Type	Nozzle		Hose barb		Weight				
		mm	mm	in	gr	oz				
21.0015.12	Fixed	1,2	7	0,27	170	6	15			✓
21.0015.18	Fixed	1,8	7	0,27	170	6	15			✓
21.0015.21	Fixed	2,1	7	0,27	170	6	15			✓
21.0015.23	Fixed	2,3	7	0,27	170	6	15			✓
21.0170.15	Adjust.	1,5	7	0,27	193	6,81	15			
21.0170.18	Adjust.	1,8	7	0,27	192	6,77	15			✓
21.0170.21	Adjust.	2,1	7	0,27	192	6,77	15			✓
21.0170.23	Adjust.	2,3	7	0,27	192	6,77	15			✓

Rated Pressure 280 bar - 28 MPa 4050 psi
 Permissible Pressure 310 bar - 31 MPa 4500 psi
 Rated Flow 30 l/min 8 USGpm
 Rated Temperature 90 °C 195 °F
 Inlet 3/8 Bsp F
 Outlet 3/8 Bsp M





CHEMICAL INJECTOR 3/8 BSP MF

P/N	Type	Nozzle		Hose barb		Weight			
		mm	mm	in	mm	in	gr		
21.0020.18	Fixed	1,8	7	0,27	152	5,36	15		✓
21.0020.21	Fixed	2,1	7	0,27	152	5,36	15		✓
21.0020.23	Fixed	2,3	7	0,27	152	5,36	15		
21.0175.18	Adjust.	1,8	7	0,27	175	6,17	15		
21.0175.21	Adjust.	2,1	7	0,27	175	6,17	15		✓
21.0175.23	Adjust.	2,3	7	0,27	174	6,14	15		✓
21.0175.25	Adjust.	2,5	7	0,27	174	6,14	15		
21.0175.27	Adjust.	2,7	7	0,27	174	6,14	15		

Rated Pressure	280 bar - 28 MPa	4050 psi
Permissible Pressure	310 bar - 31 MPa	4500 psi
Rated Flow	30 l/min	8 USGpm
Rated Temperature	90 °C	195 °F
Inlet		3/8 Bsp M
Outlet		3/8 Bsp F



CHEMICAL INJECTOR 3/8 BSP M × M22 M

P/N	Type	Nozzle		Hose barb		Weight			
		mm	mm	in	mm	in	gr		
21.0030.18	Fixed	1,8	7	0,27	137	4,83	15		✓
21.0030.21	Fixed	2,1	7	0,27	137	4,83	15		✓
21.0030.23	Fixed	2,3	7	0,27	137	4,83	15		
21.0180.18	Adjust.	1,8	7	0,27	160	5,64	15		✓
21.0180.21	Adjust.	2,1	7	0,27	160	5,64	15		✓
21.0180.23	Adjust.	2,3	7	0,27	160	5,64	15		✓

Rated Pressure	280 bar - 28 MPa	4050 psi
Permissible Pressure	310 bar - 31 MPa	4500 psi
Rated Flow	30 l/min	8 USGpm
Rated Temperature	90 °C	195 °F
Inlet		3/8 Bsp M
Outlet		AR1 A M22

Inlet 3/8 Bsp M - outlet M 21 M version available on request



CHEMICAL INJECTOR M22 × 1,5 FM

P/N	Type	Nozzle		Hose barb		Weight			
		mm	mm	in	mm	in	gr		
21.0035.18	Fixed	1,8	7	0,27	220	7,76	10		✓
21.0035.21	Fixed	2,1	7	0,27	250	8,8	10		
21.0185.18	Adjust.	1,8	7	0,27	243	8,57	10		✓
21.0185.21	Adjust.	2,1	7	0,27	243	8,57	10		
21.0185.23	Adjust.	2,3	7	0,27	243	8,57	10		

Rated Pressure	220 bar - 22 MPa	3200 psi
Permissible Pressure	250 bar - 25 MPa	3650 psi
Rated Flow	30 l/min	8 USGpm
Rated Temperature	90 °C	195 °F
Inlet		AR1 B M22
Outlet		AR1 A M22



SST EXTENDED CHEMICAL INJECTOR 3/8 BSP MM

P/N	Nozzle			Hose barb		Weight			
	mm	mm	in	gr	oz				
21.0500.12	1,2	7	0,27	282	9,95	1			
21.0500.14	1,4	7	0,27	282	9,95	1			
21.0500.18	1,8	7	0,27	282	9,95	1			
21.0500.21	2,1	7	0,27	282	9,95	1			

Rated Pressure	250 bar - 25 MPa	3650 psi
Permissible Pressure	280 bar - 28 MPa	4100 psi
Rated Flow	30 l/min	8 USGpm
Rated Temperature	90 °C	195 °F
Inlet		3/8 Bsp M
Outlet		3/8 Bsp M
Material	Stainless steel 303	
Type	Adjust.	



Injector with high suction power

SST CHEMICAL INJECTOR 3/8 BSP MM - TEFLON O-RING

P/N	Couplings	Type	Nozzle		Weight			
			mm	gr	oz			
21.0018.12	3/8 Bsp MM	Fixed	1,2	125	4,41	10		✓
21.0018.15	3/8 Bsp MM	Fixed	1,5	125	4,41	10		✓
21.0018.21	3/8 Bsp MM	Fixed	2,1	124	4,37	10		✓
21.0018.68	3/8 Npt MM	Fixed	1,8	125	4,41	10		✓
21.0018.71	3/8 Npt MM	Fixed	2,1	124	4,37	10		
21.0119.15	3/8 Bsp MM	Adjust.	1,5	146	5,15	10		
21.0119.18	3/8 Bsp MM	Adjust.	1,8	146	5,15	10		
21.0119.21	3/8 Bsp MM	Adjust.	2,1	146	5,15	10		✓
21.0120.18	3/8 Npt MM	Adjust.	1,8	146	5,15	10		
21.0120.21	3/8 Npt MM	Adjust.	2,1	146	5,15	10		✓
21.0120.23	3/8 Npt MM	Adjust.	2,3	146	5,15	10		

Rated Pressure	350 bar - 35 MPa	5100 psi
Permissible Pressure	390 bar - 39 MPa	5650 psi
Rated Flow	30 l/min	8 USGpm
Rated Temperature	90 °C	195 °F
Hose barb	7 mm	0,27 in
Material	Stainless steel	
Inlet		3/8 Bsp M
Outlet		3/8 Bsp M

Teflon O-rings



EXTENDED CHEMICAL INJECTOR+ARS220 A+B

P/N	Material	Nozzle	Col.	Hose length		Weight			
				m	yd	gr	oz		
21.0622.14	Brass	1,4	Red	1,5	1,64	642	22,83	1	
21.0622.18	Brass	1,8	Blue	1,5	1,64	642	22,83	1	
21.0520.18	Stainless steel 303	1,8	Black	1,5	1,64	606	21,37	1	

Rated Pressure	220 bar - 22 MPa	3200 psi
Permissible Pressure	250 bar - 25 MPa	3650 psi
Rated Flow	30 l/min	8 USGpm
Rated Temperature	90 °C	195 °F
Inlet		ARS 220 "A"
Outlet		ARS 220 "B"
Type	Adjust.	

Injector with high suction power





LS3-2 - FOAMER WITH TANK

P/N	Inlet	Nozzle	Nozzle type	Weight			
				gr	oz		
25.1520.12	1/4 Bsp F	1,25	Horizontal	470	16,58	6	✓
25.1520.14	1/4 Bsp F	1,40	Horizontal	468	16,51	6	✓
25.1526.62	1/4 Bsp F	1,25	Vertical	470	16,6	6	✓
Rated Pressure	160 bar - 16 MPa			2300 psi			
Permissible Pressure	180 bar - 18 MPa			2600 psi			
Rated Flow		12 l/min		3,2 USGpm			
Rated Temperature		60 °C		140 °F			
Tank		1 L		0,264 USg			



LS 3 - FOAMER - SUCTION THROUGH EXTERNAL INJECTOR

P/N	Inlet	Nozzle	Weight			
			gr	oz		
25.1530.18	1/4 F-3/8 MM Bsp	1,8	584	20,6	5	
Rated Pressure	160 bar - 16 MPa		2300 psi			
Permissible Pressure	180 bar - 18 MPa		2600 psi			
Rated Flow		20 l/min	5,3 USGpm			
Rated Temperature		60 °C	140 °F			



LS 12 - FOAMER

P/N	Mat.	Inlet	Nozzle	Weight			
				gr	oz		
25.1800.65	Brass	1/4 Bsp F	1,5	390	13,76	5	✓
25.1815.65	St. steel	1/4 Bsp F	1,5	370	13	5	
Rated Pressure	200 bar - 20 MPa		2900 psi				
Permissible Pressure	220 bar - 22 MPa		3200 psi				
Rated Flow		25 l/min	6,5 USGpm				
Rated Temperature		60 °C	140 °F				



LS 12 - FOAMER WITH TANK

P/N	Inlet	Nozzle	Tank		Mat.	Weight			
			L	USg		gr	oz		
25.1840.65	1/4 Bsp F	1,5	1	0,26	Brass	497	17,53	5	✓
25.1840.68	1/4 Bsp F	1,8	1	0,26	Brass	497	17,53	5	
25.1840.71	1/4 Bsp F	2,1	1	0,26	Brass	494	17,42	5	✓
25.1842.65	1/4 Bsp F	1,5	2	0,52	Brass	540	19,05	5	✓
25.1843.65	1/4 Bsp F	1,5	2	0,52	St. steel	522	18,41	5	✓
Rated Pressure	200 bar - 20 MPa				2900 psi				
Permissible Pressure	220 bar - 22 MPa				3200 psi				
Rated Flow		25 l/min			6,5 USGpm				
Rated Temperature		60 °C			140 °F				



LS12 ASP.E - FOAMER - SUCTION THROUGH EXTERNAL INJECTOR

P/N	Max. flow rate		Col.	Weight			
	l/min	USGpm		gr	oz		
25.1845.18	10	2,6	Black	618	21,8	5	✓
25.1845.21	15	4	Red	617	21,76	5	✓
25.1845.25	25	6,5	Blue	617	21,76	5	✓
Rated Pressure	200 bar - 20 MPa				2900 psi		
Permissible Pressure	220 bar - 22 MPa				3200 psi		
Rated Temperature	60 °C				140 °F		
Inlet					1/4 F-3/8 MM Bsp		



LS 10 - FOAMER

P/N	Inlet	Nozzle	Weight				
			mm	gr			oz
25.1860.50	1/4 Bsp F	1,5	367	12,94	5	✓	
25.1860.65	3/8 Bsp M	1,5	366	12,91	5	✓	
Rated Pressure	200 bar - 20 MPa				2900 psi		
Permissible Pressure	220 bar - 22 MPa				3200 psi		
Rated Flow	25 l/min				6,5 USGpm		
Rated Temperature	65 °C				150 °F		



LS 10 - FOAMER WITH TANK

P/N	Inlet	Nozzle	Tank		Weight			
			L	USg	gr	oz		
25.1865.65	3/8 Bsp M	1,5	1	0,26	468	16,5	5	✓
25.1868.65	3/8 Bsp M	1,5	2	0,52	508	17,9	5	✓
Rated Pressure	200 bar - 20 MPa				2900 psi			
Permissible Pressure	220 bar - 22 MPa				3200 psi			
Rated Flow	25 l/min				6,5 USGpm			
Rated Temperature	65 °C				150 °F			





BTZ - SINGLE ROTATING CEILING BOOM

P/N	Type	Length		Inlet	Weight		
		mm	in.		gr	oz	
28.3500.00	Straight	1500	59	1/4 Bsp F	7400	261	2
28.3530.00	Straight	1650	65	1/4 Bsp F	7800	275,11	2
Rated Pressure	250 bar - 25 MPa		3650 psi				
Permissible Pressure	280 bar - 28 MPa		4050 psi				
Rated Flow	40 l/min		10,5 USGpm				
Rated Temperature	90 °C		195 °F				
Angle of rotation	360°						
Material	Zinc plated steel						



BTD /I -S - SINGLE ROTATING CEILING BOOM

P/N	Type	Length		Inlet	Weight		
		mm	in.		gr	oz	
28.3320.00	Inclined	1815	71,45	1/4 Bsp F	8000	282,17	2
28.3370.00	Straight	1815	71,45	1/4 Bsp F	8000	282,17	2
Entirely built in Stainless steel, with 2 maintenance-free, double-sealed ball bearings, which allow an easy, 360° rotation. EPDM seals ensure chemical compatibility of the boom with detergents which can damage the standard Viton seals.							
Rated Pressure	250 bar - 25 MPa		3650 psi				
Permissible Pressure	280 bar - 28 MPa		4050 psi				
Rated Flow	40 l/min		10,5 USGpm				
Rated Temperature	90 °C		195 °F				
Angle of rotation	360°						
Outlet	3/8 Bsp M						
Material	Stainless steel						
Seals material	Epdm						



Entirely built in Stainless steel, with 2 maintenance-free, double-sealed ball bearings, which allow an easy, 360° rotation. EPDM seals ensure chemical compatibility of the boom with detergents which can damage the standard Viton seals.

BTE - SINGLE ROTATING CEILING BOOM

P/N	Type	Length		Inlet	Weight		
		mm	in.		gr	oz	
28.3300.00	Inclined	1980	77,95	1/4 Bsp F	8980	317	2
28.3350.00	Straight	1980	77,95	1/4 Bsp F	9000	317,43	1
Rated Pressure	250 bar - 25 MPa		3650 psi				
Permissible Pressure	280 bar - 28 MPa		4050 psi				
Rated Flow	40 l/min		10,5 USGpm				
Rated Temperature	90 °C		195 °F				
Angle of rotation	360°						
Material	Stainless steel						



BTI - SINGLE ROTATING CEILING BOOM - INCLINED

P/N	Length		Inlet	Weight			
	mm	in.		gr	oz		
28.3150.00	1820	71,7	1/4 Bsp F	12200	430,3	2	
Rated Pressure	250 bar - 25 MPa		3650 psi				
Permissible Pressure	280 bar - 28 MPa		4050 psi				
Rated Flow	40 l/min		10,5 USGpm				
Rated Temperature	90 °C		195 °F				
Angle of rotation	360°						
Material	Stainless steel						



BTC - BENT ROTATING CEILING BOOM

P/N	Length		Inlet	Weight			
	mm	in.		gr	oz		
28.3080.00	1550	61,1	1/4 Bsp F	11000	388	2	
Rated Pressure	250 bar - 25 MPa		3650 psi				
Permissible Pressure	280 bar - 28 MPa		4050 psi				
Rated Flow	40 l/min		10,5 USGpm				
Rated Temperature	90 °C		195 °F				
Angle of rotation			360°				
Material			Stainless steel				



BTR - SINGLE ROTATING CEILING BOOM - 2 SPRINGS

P/N	Length		Inlet	Weight			
	mm	in.		gr	oz		
28.3000.00	1750	68,9	1/4 Bsp F	11400	402,09	1	
28.3020.00	2000	78,75	1/4 Bsp F	11800	416,2	1	
28.3025.00	2500	98,42	1/4 Bsp F	13000	458,52	1	
Rated Pressure	250 bar - 25 MPa		3650 psi				
Permissible Pressure	280 bar - 28 MPa		4050 psi				
Rated Flow	40 l/min		10,5 USGpm				
Rated Temperature	90 °C		195 °F				
Angle of rotation			360°				
Material			Stainless steel				



BTD - DOUBLE CEILING ROTATING BOOM

P/N	Length		Inlet	Weight			
	mm	in.		gr	oz		
28.3100.00	1750 - 1600	68,9 - 63		20600	726,58	1	
28.3100.20	2000 - 1750	78,7 - 68,9		21600	761,85	1	
28.3100.25	2500 - 2000	100 - 78,7		23200	818,28	1	
Rated Pressure	250 bar - 25 MPa		3650 psi				
Permissible Pressure	280 bar - 28 MPa		4050 psi				
Rated Flow	40 l/min		10,5 USGpm				
Rated Temperature	90 °C		195 °F				
Inlet			1/4 Bsp F				
Angle of rotation			360°				
Material			Stainless steel				



WALL MOUNT FRAME

P/N	Height		Width		Weight			
	mm	in.	mm	in.	gr	oz		
28.3045.21R	190	7,48	217	8,54	5000	176,4	1	✓
Angle of rotation							180°	
Material							Zinc plated steel	





SLP- PLAS.LANCE HOLDER

P/N	Material	Col.	Weight			
			gr	oz		
28.3230.00	PE	Blue	1276	45	2	✓
28.3230.30	PE	Gray	1276	45	2	✓



SLI - STAINLESS STEEL LANCE HOLDER

P/N	Hose Ø		Weight			
	mm	in	gr	oz		
28.3200.00	73	2,87	2424	85,5	1	✓

Material: Stainless steel



VP - PE BRUSH TANK

P/N	Material	Col.	Weight			
			gr	oz		
28.3270.00	PE	Blue	3400	120	1	✓
28.3270.30	PE	Gray	3361	118,55	1	✓

Length: 424 mm / 16,7 in.
 Width: 197 mm / 7,76 in.
 Height: 585 mm / 23,03 in.



URF 180 - ROTATING HEAD

P/N	Inlet		Outlet		Weight		
					gr	oz	
25.1130.00	1/4 Npt M	2 × 1/8 Bsp F	170	6	5	✓	
Rated Pressure	250 bar - 25 MPa		3650 psi				
Permissible Pressure	280 bar - 28 MPa		4050 psi				
Rated Flow	30 l/min		8 USGpm				
Rated Temperature	0-80 °C		32-175 °F				



URF 400 - ROTATING HEAD

P/N	Inlet		Outlet		Weight		
					gr	oz	
25.1170.00	1/2 Bsp F	2 × 1/4 Bsp F	440	15,52	1	✓	
Rated Pressure	350 bar - 35 MPa		5100 psi				
Permissible Pressure	390 bar - 39 MPa		5650 psi				
Rated Flow	80 l/min		21 USGpm				
Rated Temperature	0-80 °C		32-175 °F				



GR 38 - ROTATING TANK CLEANER

P/N	Inlet		Outlet		Weight		
					gr	oz	
26.1400.00	3/8 Bsp M	2 x M12 F	637	22,47	1	✓	
Rated Pressure	350 bar - 35 MPa		5100 psi				
Permissible Pressure	390 bar - 39 MPa		5650 psi				
Rated Flow	40 l/min		10,5 USGpm				
Rated Temperature	120 °C		250 °F				
Max. working temperature	0-90 °C		32-195 °F				



GR38/200-400 - ROTATING HEAD

P/N	Width		Inlet	Outlet	Weight		
	mm	in			gr	oz	
26.1420.00	210	8,26	3/8 Bsp M	2 × 1/8 Npt F	759	26,77	1 ✓
26.1440.00	400	15,75	3/8 Bsp M	2 × 1/8 Npt F	852	30,05	1 ✓
Rated Pressure	350 bar - 35 MPa		5100 psi				
Permissible Pressure	390 bar - 39 MPa		5650 psi				
Rated Flow	40 l/min		10,5 USGpm				
Rated Temperature	120 °C		250 °F				
Max. working temperature	0-90 °C		32-195 °F				





GR58/400 - ROTATING HEAD

P/N	Width		Inlet	Outlet	Weight		1
	mm	in			gr	oz	
26.1460.00	400	15,75	1/2 Bsp F	2 × 1/8 Npt F	1580	55,7	1
Rated Pressure	500 bar - 50 MPa				7250 psi		
Permissible Pressure	560 bar - 56 MPa				8100 psi		
Rated Flow	40 l/min				10,5 USGpm		
Rated Temperature	120 °C				250 °F		
Max. working temperature	0-90 °C				32-195 °F		



M21E - ELECTRIC-DRIVEN BARREL CLEANER

P/N	Length		Power supply	Weight		1
	mm	in.		gr	oz	
25.4300.00	550	21,7	230V 50Hz AC	3378	119,15	1 ✓
25.4300.62	550	21,7	110V 60Hz AC Jap.	3200	111	1
12.5073.00	0	0	115V Usa+230V Aust.	30	1	1
Inlet					AR1 A M22	
Rated Pressure	220 bar - 22 MPa				3200 psi	
Permissible Pressure	250 bar - 25 MPa				3650 psi	
Rated Flow	21 l/min				5,5 USGpm	
Rated Temperature	0-90 °C				32-195 °F	
Electric motor					12 V DC - 8 W	
Cable length	10.000 mm				394 in	
Min.overall Ø	40 mm				1,57 in	
Nozzle type					2 × M4	



Standard M4 nozzles supplied: 02-025-03-035-04

M25E - ELECTRIC-DRIVEN BARREL CLEANER + FLUID SUCTION

P/N	Barrel Ø		Power supply	Weight		1
	mm	in		gr	oz	
25.4350.00	730	28,7	230V 50Hz AC	5570	196,46	1 ✓
25.4350.25	730	28,7	24V AC	5100	180	1
25.4363.00	680	26,7	220V AC	5405	190,64	1
Shortened flexible version for reduced space						
25.4363.25	680	26,7	24V AC	5730	202,1	1
Shortened flexible version for reduced space						
12.5073.00	0	0	115V Usa+230V Aust.	30	1	1
Inlet					AR1 A M22	
Rated Pressure	140 bar - 14 MPa				2000 psi	
Permissible Pressure	160 bar - 16 MPa				2300 psi	
Rated Flow	10-25 l/min				2,6-6,5 USGpm	
Rated Temperature	0-90 °C				32-195 °F	
Electric motor					12 V DC - 8 W	
Cable length	10.000 mm				394 in	
Min.overall Ø	40 mm				1,57 in	
Nozzle type					2 × M4	



Standard M4 nozzles supplied: 02-025-03-035-04

M28E - ELECTRIC-DRIVEN BARREL CLEANER + FLUID SUCTION

P/N	Barrel Ø		Power supply	Weight		
	mm	in		gr	oz	
25.4380.00	640	25,2	220V AC	5955	210,04	1
Shortened flexible version for reduced space						
12.5073.00	0	0	115V Usa+230V Aust.	30	1	1

Inlet		AR1 A M22
Rated Pressure	140 bar - 14 MPa	2000 psi
Permissible Pressure	160 bar - 16 MPa	2300 psi
Rated Flow	10-25 l/min	2,6-6,5 USGpm
Rated Temperature	0-90 °C	32-195 °F
Electric motor		12 V DC - 8 W
Cable length	10.000 mm	394 in
Min. overall Ø	40 mm	1,57 in
Nozzle type		2 × M4

Standard M4 nozzles supplied: 02-025-03-035-04

HOLDER FOR M28E L-SHAPED BARREL CLEANER

P/N	Hole size		Length		Weight		
	mm	in	mm	in.	gr	oz	
25.4385.00	62,8	2,47	150	5,9	282	10	1

CABLE EXTENSION - 20 M - 12 V DC - MF

P/N	Couplings	Weight	
		gr	oz
25.4353.20R	M - F	1147	40,5
Cable length		20.000 mm	786 in

Suitable for M21 and M25

M63E - M63P - SELF-PROPELLED TANK CLEANER HEAD- Ø45 MM -



P/N	Type	Certification	Length		Weight		
			mm	in.	gr	oz	
25.4500.04	Electr.- CE	CE	915	36	5075	179	1
25.4520.04	Air-driven	-	915	36	4698	165,7	1
25.4526.04	Air-driven	-	650	25,6	4248	149,83	1

Inlet		3/8 Bsp F
Rated Pressure	140 bar - 14 MPa	2000 psi
Min. operating pressure	40 bar - 4 MPa	580 psi
Permissible Pressure	160 bar - 16 MPa	2300 psi
Rated Flow	15-50 l/min	4-13,2 USGpm
Rated Temperature	0-90 °C	32-195 °F
Max. Voltage		24V AC
Min. overall Ø	45 mm	1,8 in
Nozzle type		4 × M4







M63E - M63P - SELF-PROPELLED TANK CLEANER - Ø50 MM - CE

P/N	Type	Certification	Length		Weight		 
			mm	in.	gr	oz	
25.4500.00	Electr.- CE	CE	915	36	5086	179,39	1
25.4506.00	Electr.- CE	CE	650	25,6	4626	164,5	1
25.4520.00	Air-driven	-	915	36	4766	168,1	1
25.4526.00	Air-driven	-	650	25,6	3940	138,9	1

Inlet		3/8 Bsp F
Rated Pressure	140 bar - 14 MPa	2000 psi
Permissible Pressure	160 bar - 16 MPa	2300 psi
Rated Flow	15 - 50 l/min	4 - 13,2 USGpm
Rated Temperature	0-90 °C	32-195 °F
Max. Voltage		24V AC
Min. overall Ø	65 mm	2,5 in
Nozzle type		4 × 1/8 Npt



MI85 - M85E - M85P - SELF-PROPELLED TANK CLEANER - CE Ex



P/N	Type	Certification	Inlet	Length		Weight		 
				mm	in.	gr	oz	
25.4750.20	Hydr.-driven		3/4 Bsp F	915	36	7200	254	1
25.4770.00	Electr.- CE	CE	3/8 Bsp F	915	36	5452	192,3	1
25.4720.00	Air-driven	-	3/8 Bsp F	915	36	5062	178,54	1

Rated Pressure	140 bar - 14 MPa	2000 psi
Min. operating pressure	30 bar - 3 MPa	435 psi
Permissible Pressure	160 bar - 16 MPa	2300 psi
Rated Flow	20-80 l/min	5,3-21 USGpm
Rated Temperature	0-90 °C	32-195 °F
Nozzle type		4 × 1/4 Npt
Max. Voltage		24V AC
Min. overall Ø	86 mm	3,4 in
Rotational Speed		10-16 giri/min



Nozzles not included.
To choose the right part no., please fill in the selection questionnaire.

MI63 - HYDRAULIC-DRIVEN TANK CLEANER - Ø45 MM

P/N	Length		Max. flow rate		Weight		 
	mm	in.	l/min	USGpm	gr	oz	
25.4600.24	915	36	15-21	4-5,5	7176	253,1	1

Inlet		3/4 Bsp F
Rated Pressure	140 bar - 14 MPa	2000 psi
Min. operating pressure	30 bar - 3 MPa	435 psi
Permissible Pressure	160 bar - 16 MPa	2300 psi
Rated Flow	15-50 l/min	4-13,2 USGpm
Rated Temperature	0-90 °C	32-195 °F
Min. overall Ø	45 mm	1,8 in
Nozzle type		4 × M4
Rotational Speed		10-16 giri/min



Nozzles not included.
To choose the right part no., please fill in the selection questionnaire.

MI63 - HYDRAULIC-DRIVEN TANK CLEANER - Ø50 MM

P/N	Length		Max. flow rate		Weight			
	mm	in.	l/min	USGpm	gr	oz		
25.4600.20	915	36	15-21	4-5,5	7049	248,62	1	
25.4603.20	363	14,3	15-21	4-5,5	6153	217,02	1	
25.4600.30	915	36	25-30	6,6-8	7219	254,62	1	
25.4600.40	915	36	30-40	8-10	7219	254,62	1	
25.4600.50	915	36	40-50	10,6-13,2	7235	255,18	1	



Inlet		3/4 Bsp F
Rated Pressure	140 bar - 14 MPa	2000 psi
Min. operating pressure	30 bar - 3 MPa	435 psi
Permissible Pressure	160 bar - 16 MPa	2300 psi
Rated Flow	15-50 l/min	4-13,2 USGpm
Rated Temperature	0-90 °C	32-195 °F
Min. overall Ø	65 mm	2,5 in
Nozzle type		4 × 1/8 Npt
Rotational Speed		10-16 giri/min

Nozzles not included.

To choose the right part no., please fill in the selection questionnaire.

MI63A - HYDRAULIC-DRIVEN TANK CLEANER - ATEX 2460

P/N	Min. overall Ø		Length		Nozzle type	Max. flow rate		Weight			
	mm	in	mm	in.		l/min	USGpm	gr	oz		
25.4902.25	65	2,5	915	36	4 × 1/8 Npt	20-25	5,3-6,6	7268	256,35	1	
25.4902.29	45	1,8	915	36	4 × M4	20-25	5,3-6,6	7268	256,35	1	

Rated Pressure	140 bar - 14 MPa	2000 psi
Min. operating pressure	30 bar - 3 MPa	435 psi
Permissible Pressure	160 bar - 16 MPa	2300 psi
Rated Flow	15-50 l/min	4-13,2 USGpm
Rated Temperature	0-90 °C	32-195 °F
Rotational Speed		10-16 giri/min

Nozzles not included.

To choose the right part no., please fill in the selection questionnaire.

A50R - SELF-PROPELLED TANK CLEANER

P/N	Max. flow rate		Min. overall Ø		Weight			
	l/min	USGpm	mm	in	gr	oz		
25.4100.50	40-50	10,6-13,2	165	6,4	6040	213	1	



Inlet		1/2 Bsp F
Rated Pressure	140 bar - 14 MPa	2000 psi
Min. operating pressure	30 bar - 3 MPa	435 psi
Rated Flow	20-50 l/min	5,3-13 USGpm
Rated Temperature	0-90 °C	32-195 °F
Material		Stainless steel 303
Nozzle type		3 × 1/8 Npt
Rotational Speed		10-16 giri/min
Max. RPM		20 giri/min

Nozzles not included.

To choose the right part no., please fill in the selection questionnaire.





A50R-360° - SELF-PROPELLED TANK CLEANER **NEW**

P/N	Max. flow rate		Min. overall Ø		Weight		1
	l/min	USGpm	mm	in	gr	oz	
25.4200.50	40-50	10,6-13,2	165	6,4	7640	269	1

Inlet						1/2 Bsp F
Rated Pressure		140 bar - 14 MPa				2000 psi
Min. operating pressure		30 bar - 3 MPa				435 psi
Rated Flow		20-50 l/min			5,3-13 USGpm	
Rated Temperature		0-90 °C				32-195 °F
Material						Stainless steel 303
Nozzle type						4 × 1/8 Npt
Rotational Speed						10-16 giri/min
Max. RPM						20 giri/min

Nozzles not included.
To choose the right part no., please fill in the selection questionnaire.



A80R - SELF-PROPELLED TANK CLEANER

P/N	Max. flow rate		Min. overall Ø		Weight		1
	l/min	USGpm	mm	in	gr	oz	
25.4820.00	-	-	165	6,4	5892	207,81	1
25.4820.20	15-21	4-5,5	165	6,4	6034	212,82	1
25.4820.25	20-25	5,3-6,6	165	6,4	6048	213,32	1
25.4820.30	25-30	6,6-8	165	6,4	6074	214,24	1
25.4820.40	30-40	8-10,6	165	6,4	6136	216,42	1
25.4820.50	40-50	10,6-13,2	165	6,4	6120	215,86	1
25.4820.60	50-60	13,2-16	165	6,4	6096	215,01	1
25.4820.70	60-70	16-18,5	165	6,4	6100	215,15	1
25.4820.80	70-85	18,5-22,5	165	6,4	5900	208,1	1
25.4820.90	85-120	22,5-31,7	165	6,4	6825	240,72	1

Inlet						3/4 Bsp F
Rated Pressure		140 bar - 14 MPa				2000 psi
Min. operating pressure		30 bar - 3 MPa				435 psi
Permissible Pressure		160 bar - 16 MPa				2300 psi
Rated Flow		20-120 l/min			5,3-32 USGpm	
Rated Temperature		0-90 °C				32-195 °F
Material						Stainless steel 303
Nozzle type						4 × 1/4 Npt
Rotational Speed						10-16 giri/min
Max. RPM						20 giri/min

Nozzles not included.
To choose the right part no., please fill in the selection questionnaire.



A80RA - SELF-PROPELLED TANK CLEANER - ATEX 2460

P/N	Max. flow rate		Min. overall Ø		Weight			
	l/min	USGpm	mm	in	gr	oz		
25.4872.50	40-50	10,6-13,2	165	6,4	5992	211,34	1	
25.4872.60	50-60	13,2-16	165	6,4	5976	210,78	1	
25.4872.80	70-85	18,5-22,5	165	6,4	5975	210,74	1	

Inlet		3/4 Bsp F
Rated Pressure	140 bar - 14 MPa	2000 psi
Min. operating pressure	30 bar - 3 MPa	435 psi
Permissible Pressure	160 bar - 16 MPa	2300 psi
Rated Flow	20-120 l/min	5,3-32 USGpm
Rated Temperature	0-90 °C	32-195 °F
Material		Stainless steel 303
Nozzle type		4 × 1/4 Npt
Rotational Speed		10-16 giri/min
Max. RPM		20 giri/min

Nozzles not included.

To choose the right part no., please fill in the selection questionnaire.

A80LU - SELF-PROPELLED TANK CLEANER - HF HNO3

P/N	Max. flow rate		Min. overall Ø		Weight			
	l/min	USGpm	mm	in	gr	oz		
25.4860.00	-	-	165	6,4	5300	184	1	
25.4860.50	60-70	16-18,5	165	6,4	6000	211,6	1	
25.4860.80	100-120	26,4-31,7	165	6,4	6000	211,6	1	

Inlet		3/4 Bsp F
Rated Pressure	140 bar - 14 MPa	2000 psi
Min. operating pressure	30 bar - 3 MPa	435 psi
Permissible Pressure	160 bar - 16 MPa	2300 psi
Rated Flow	30-100 l/min	8-26,5 USGpm
Rated Temperature	0-90 °C	32-195 °F
Material		Stainless steel 303
Nozzle type		4 × 1/4 Npt
Rotational Speed		10-20 giri/min

Suitable for use with chemicals containing nitric acid (HNO₃) and hydrofluoric acid (HF)

Nozzles not included.

To choose the right part no., please fill in the selection questionnaire.

A80R2 - SELF-PROPELLED TANK CLEANER

P/N	Rated Flow		Min. overall Ø		Weight			
	l/min	USGpm	mm	in	gr	oz		
25.4850.00	-	-	165	6,4	5300	184	1	
25.4850.50	40-50	10,6-13,2	165	6,4	5900	208,1	1	
25.4850.70	60-70	16-18,5	165	6,4	6674	235,4	1	

Inlet		3/4 Bsp F
Rated Pressure	140 bar - 14 MPa	2000 psi
Min. operating pressure	30 bar - 3 MPa	435 psi
Permissible Pressure	160 bar - 16 MPa	2300 psi
Rated Flow	20-80 l/min	5,3-21 USGpm
Rated Temperature	0-90 °C	32-195 °F
Material		Stainless steel 303
Nozzle type		4 × 1/4 Npt
Max. RPM		150 giri/min
Rotational Speed		60-120 giri/min

Nozzles not included.

To choose the right part no., please fill in the selection questionnaire.





A80FR2 - SELF-PROPELLED TANK CLEANER - FRONT AND SIDE CLEANING

P/N	Max. flow rate		Min. overall Ø		Weight			
	l/min	USGpm	mm	in	gr	oz		
25.4840.00	-	-	800	32	5004	176,5	1	
25.4840.20	18-21	4,8-5,5	800	32	4500	158,7	1	
25.4840.25	20-30	5,3-7,9	800	32	5020	177,08	1	
25.4840.40	40-50	10,6-13,2	800	32	4500	158,7	1	
25.4840.50	50-60	13,2-15,9	800	32	5096	179,74	1	

Inlet		3/4 Bsp F
Rated Pressure	140 bar - 14 MPa	2000 psi
Min. operating pressure	30 bar - 3 MPa	435 psi
Permissible Pressure	160 bar - 16 MPa	2300 psi
Rated Flow	20-80 l/min	5,3-21 USGpm
Rated Temperature	0-90 °C	32-195 °F
Material		Stainless steel 303
Nozzle type		2 × 1/4 Npt
Max. RPM		150 giri/min

Nozzles not included.
To choose the right part no., please fill in the selection questionnaire.



A80RF- SELF-PROPELLED TANK CLEANER -

P/N	Max. flow rate		Min. overall Ø		Weight			
	l/min	USGpm	mm	in	gr	oz		
25.4890.00	-	-	150,7	5,94	7600	268	1	
25.4890.90	85-120	22,5-31,7	150,7	5,94	7600	268	1	

Inlet		3/4 Bsp F
Rated Pressure	140 bar - 14 MPa	2000 psi
Min. operating pressure	30 bar - 3 MPa	435 psi
Permissible Pressure	160 bar - 16 MPa	2300 psi
Rated Flow	20-120 l/min	5,3-32 USGpm
Rated Temperature	0-90 °C	32-195 °F
Material		Stainless steel 303
Nozzle type		4 × 1/4 Npt
Rotational Speed		10-16 giri/min
Max. RPM		20 giri/min

Nozzles not included.
To choose the right part no., please fill in the selection questionnaire.

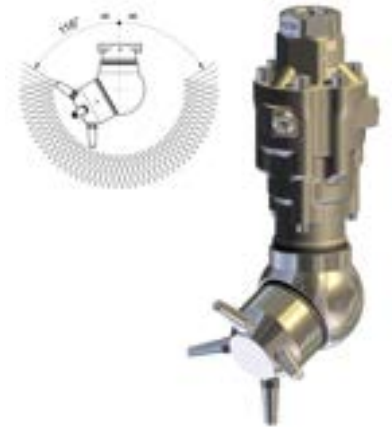

A300R - SELF-PROPELLED TANK CLEANER

P/N	Rated Flow		Nozzle type	Min. overall Ø		Weight			
	l/min	USGpm		mm	in	gr	oz		
25.6000.10	100	26,45	4 × 1/4 Npt	183	7,19	10200	360	1	
25.6000.15	130	34,36	4 × 1/4 Npt	183	7,19	10200	360	1	
25.6000.17	150	38,86	4 × 1/4 Npt	183	7,19	10200	360	1	
25.6000.20	180	46,63	4 × 1/4 Npt	183	7,19	10200	360	1	
25.6000.24	220	57	4 × 1/4 Npt	183	7,19	10200	360	1	
25.6000.30	300	79,3	4 × 1/4 Npt	183	7,19	10200	360	1	

Inlet		1" 1/4 Bsp F
Rated Pressure	70 bar - 7 MPa	1015 psi
Min. operating pressure	30 bar - 3 MPa	435 psi
Rated Flow	100-300 l/min	26,4-79,3 USGpm
Rated Temperature	0-90 °C	32-195 °F
Material		Stainless steel 303
Rotational Speed		4-5 giri/min
Max. RPM		6 giri/min

Nozzles not included.
To choose the right part no., please fill in the selection questionnaire.



PROTECTION FOR A80 R WITH EXTENDED NOZZLES

P/N	Mat.	Weight			
		gr	oz		
25.4822.00R	St. steel	642	22,6	1	✓

Fixing screws and nuts included



MI42-316- HYDRAULIC-DRIVEN TANK CLEANER - Ø62,5 MM - NSF-FDA CONFORM-- ATEX 2460

P/N	Rated Flow		Length		Weight			
	l/min	USGpm	mm	in.	gr	oz		
25.3650.40	35-45	9,2-12	650	25,6	5950	210	1	
25.3650.50	45-55	12-14,5	650	25,6	5950	210	1	

Rated Pressure	140 bar - 14 MPa	2000 psi
Min. operating pressure	40 bar - 4 MPa	580 psi
Permissible Pressure	160 bar - 16 MPa	2300 psi
Rated Flow	20 - 65 l/min	5,3 - 17,2 USGpm
Rated Temperature	0-90 °C	32-195 °F
Rotational Speed		18-24 giri/min
Inlet		1/2 Bsp F
Nozzle type		4 x 1/8 Npt
Min. overall Ø	62,5 mm	2,46 in
Material		Stainless steel Ai316

Nozzles not included.

To choose the right part no., please fill in the selection questionnaire.

Made completely of Stainless steel Aisi316 L. Suitable for utilization in the food Industry since materials used for manufacturing have NSF approval.



SST 316 TC3 FLANGE- TRI-CLAMP 3"+SCREWS+O-RING

P/N	Hole size		Fitting	Type	Weight			
	mm	in			gr	oz		
25.3601.24	37	1,45	M 63 - M 85	A	239	8,43	1	
25.3602.42R	37	1,45	MI 42	B	239	8,43	1	

Material Stainless steel Ai316



KIT TLR M4 AI316 -TANK CLEANER M 4 HEAD - Ø40,5MM - X MI42-316-MI63

P/N	Inlet	Nozzle type	Weight			
			gr	oz		
25.3610.24	M25x1 M	2 x M4	3752	132,34	1	

Rated Pressure	140 bar - 14 MPa	2000 psi
Min. operating pressure	40 bar - 4 MPa	580 psi
Permissible Pressure	160 bar - 16 MPa	2300 psi
Rated Flow	15 - 35 l/min	4 - 9,2 USGpm
Rated Temperature	0-90 °C	32-195 °F
Rotational Speed		18-24 giri/min
Min. overall Ø	40,5 mm	1,6 in
Material		Stainless steel Ai316

Nozzles not included. Cod. nozzles 80.0882.60>80.0889.60

To choose the right part no., please fill in the selection questionnaire.

Made completely of Stainless steel Aisi316 L. Suitable for utilization in the food Industry since materials used for manufacturing have NSF approval.





A42R-316 - SELF-PROPELLED TANK CLEANER - APPROVED -NSF FDA CE Ex
CONFORM-- ATEX 2460

P/N	Rated Flow		Min. overall Ø		Weight		1
	l/min	USGpm	mm	in	gr	oz	
25.5600.20	15-25	4-6,5	86	3,39	3590	126,6	1
25.5600.30	25-35	6,5-9,2	86	3,39	3590	126,6	1
25.5600.40	35-45	9,2-12	86	3,39	3590	126,6	1
25.5600.50	45-55	12-14,5	86	3,39	3590	126,6	1

Inlet							1/2 Bsp F
Rated Pressure		140 bar - 14 MPa					2000 psi
Min. operating pressure		40 bar - 4 MPa					580 psi
Permissible Pressure		160 bar - 16 MPa					2300 psi
Rated Flow		20 - 55 l/min		5,3 - 14,5 USGpm			
Rated Temperature		0-90 °C					32-195 °F
Nozzle type							3 × 1/8 Npt
Rotational Speed							18 - 24 giri/min
Material							Stainless steel Ai316

Nozzles not included.

To choose the right part no., please fill in the selection questionnaire.

Made completely of Stainless steel Aisi316 L. Suitable for utilization in the food Industry since materials used for manufacturing have NSF approval.



A42R-316 -360° SELF-PROPELLED TANK CLEANER - -NSF FDA CONFORM-- ATEX CE Ex
2460

P/N	Rated Flow		Min. overall Ø		Weight		1
	l/min	USGpm	mm	in	gr	oz	
25.5700.20	20-30	5-8	108	4,25	5600	197,5	1
25.5700.40	35-45	9,2-12	108	4,25	5600	197,5	1
25.5700.50	45-55	12-14,5	108	4,25	5600	197,5	1

Inlet							1/2 Bsp F
Rated Pressure		140 bar - 14 MPa					2000 psi
Min. operating pressure		40 bar - 4 MPa					580 psi
Permissible Pressure		160 bar - 16 MPa					2300 psi
Rated Flow		20 - 55 l/min		5,3 - 14,5 USGpm			
Rated Temperature		0-90 °C					32-195 °F
Nozzle type							4 × 1/8 Npt
Rotational Speed							18 - 24 giri/min
Material							Stainless steel Ai316

Nozzles not included.

To choose the right part no., please fill in the selection questionnaire.

Made completely of Stainless steel Aisi316 L. Suitable for utilization in the food Industry since materials used for manufacturing have NSF approval.



A30 R - SELF-PROPELLED TANK CLEANER

P/N	Max. flow rate		Min. overall Ø		Weight			
	l/min	USGpm	mm	in	gr	oz		
25.3300.12	9 - 12	2,3 - 3,1	60	2,36	2030	71,61	1	
25.3300.15	11 - 15	2,85 - 3,9	60	2,36	2030	71,61	1	
25.3300.18	14 - 18	3,6 - 4,6	60	2,36	2030	71,61	1	
25.3300.25	18 - 25	4,6 - 6,5	60	2,36	2030	71,61	1	
25.3300.33	25 - 33	6,5 - 8,6	60	2,36	2030	71,61	1	



Inlet		1/2 Bsp F
Rated Pressure	140 bar - 14 MPa	2000 psi
Min. operating pressure	30 bar - 3 MPa	435 psi
Permissible Pressure	160 bar - 16 MPa	2300 psi
Rated Flow	9-33 l/min	2,4-8,7 USGpm
Rated Temperature	0-90 °C	32-195 °F
Material		Stainless steel 303
Seals material		FKM (Viton) [®]
Nozzle type		4 × M4
Rotational Speed		20-30 giri/min
Max. RPM		30 giri/min

Nozzles not included.

To choose the right part no., please fill in the selection questionnaire.

A42 R - SELF-PROPELLED TANK CLEANER

P/N	Rated Flow		Min. overall Ø		Weight			
	l/min	USGpm	mm	in	gr	oz		
25.5180.20	20	5,3	86	3,39	3752	132,34	1	
25.5180.30	20-30	5,3-8	86	3,39	3648	128,66	1	
25.5180.40	30-40	8-10,5	86	3,39	3648	128,67	1	



Inlet		1/2 Bsp F
Rated Pressure	140 bar - 14 MPa	2000 psi
Min. operating pressure	40 bar - 4 MPa	580 psi
Permissible Pressure	160 bar - 16 MPa	2300 psi
Rated Flow	20 - 50 l/min	5-13,2 USGpm
Rated Temperature	0-90 °C	32-195 °F
Nozzle type		3 × 1/8 Npt
Rotational Speed		29 - 36 giri/min

Nozzles not included.

To choose the right part no., please fill in the selection questionnaire.

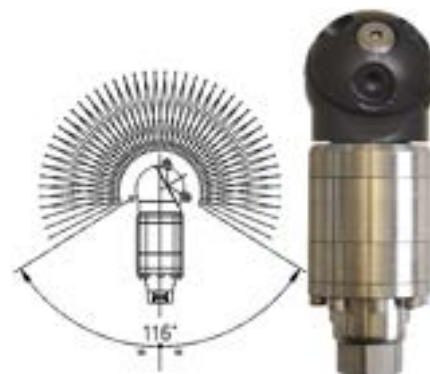
A42 R-360° - SELF-PROPELLED TANK CLEANER

P/N	Rated Flow		Min. overall Ø		Weight			
	l/min	USGpm	mm	in	gr	oz		
25.5360.15	13-17	3,4-4,5	108	4,25	3752	132,34	1	
25.5360.20	20	5,2	108	4,25	3752	132,34	1	
25.5360.25	25	6,6	108	4,25	3752	132,34	1	
25.5360.30	30	8	108	4,25	3752	132,34	1	
25.5360.35	35	9,2	108	4,25	3752	132,34	1	
25.5360.40	40	10,6	108	4,25	3752	132,34	1	
25.5360.50	50	13	108	4,25	3752	132,34	1	



Inlet		1/2 Bsp F
Rated Pressure	140 bar - 14 MPa	2000 psi
Min. operating pressure	40 bar - 4 MPa	580 psi
Permissible Pressure	160 bar - 16 MPa	2300 psi
Rated Flow	13 - 50 l/min	3,4-13,2 USGpm
Rated Temperature	0-90 °C	32-195 °F
Nozzle type		4 × 1/8 Npt
Rotational Speed		18 - 24 giri/min

Nozzles not included.

To choose the right part no., please fill in the selection questionnaire.





A42 R2 - SELF-PROPELLED TANK CLEANER

P/N	Rated Flow		Min. overall Ø		Weight			
	l/min	USGpm	mm	in	gr	oz		
25.5200.20	20	5,2	86	3,39	3436	121,19	1	
25.5200.24	20-25	5,3-6,5	86	3,39	3337	117,7	1	
25.5200.28	25-30	6,5-8	86	3,39	3434	121,12	1	
25.5200.34	30-40	8-10,5	86	3,39	3405	120,1	1	
25.5200.33	40-50	10,5-13,2	86	3,39	3434	121,12	1	

Inlet						1/2 Bsp F
Rated Pressure		140 bar - 14 MPa				2000 psi
Min. operating pressure		40 bar - 4 MPa				580 psi
Permissible Pressure		160 bar - 16 MPa				2300 psi
Rated Flow		20 - 50 l/min			5 - 13,2 USGpm	
Rated Temperature		0-90 °C				32-195 °F
Nozzle type						3 × 1/8 Npt
Rotational Speed						110-180 giri/min

Nozzles not included.
To choose the right part no., please fill in the selection questionnaire.



A42 FR 2- SELF-PROP. FRONT CLEANER - 3 NOZZLES - SAME ANGLE

P/N	Rated Flow		Min. overall Ø		Weight			
	l/min	USGpm	mm	in	gr	oz		
25.5150.20	20	5,3	72	2,8	3246	114,49	1	
25.5150.26	20-30	5,3-8	72	2,8	3151	111,14	1	
25.5150.40	30-40	8-10,5	72	2,8	3148	111,03	1	
25.5150.33	50-60	13,2-16	72	2,8	3218	113,5	1	

Inlet						1/2 Bsp F
Rated Pressure		140 bar - 14 MPa				2000 psi
Min. operating pressure		40 bar - 4 MPa				580 psi
Permissible Pressure		160 bar - 16 MPa				2300 psi
Rated Flow		20 - 60 l/min			5 - 16 USGpm	
Rated Temperature		0-90 °C				32-195 °F
Nozzle type						3 × 1/4 Npt
Rotational Speed						180 - 260 giri/min

Nozzles not included.
To choose the right part no., please fill in the selection questionnaire.

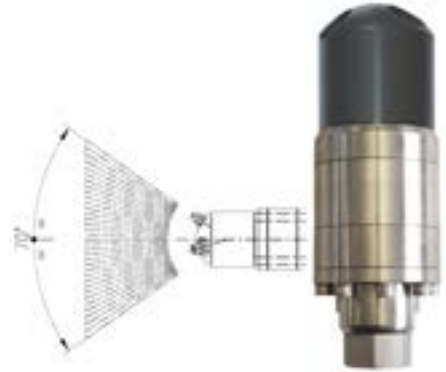

A42 FR 2-45°- SELF-PROP. FRONT CLEANER - 3 NOZZLES 45°

P/N	Rated Flow		Min. overall Ø		Weight			
	l/min	USGpm	mm	in	gr	oz		
25.5194.26	20-30	5,3-8	72	2,8	3162	111,53	1	
25.5194.35	30-35	8-9,2	72	2,8	3165	111,63	1	

Inlet						1/2 Bsp F
Rated Pressure		140 bar - 14 MPa				2000 psi
Min. operating pressure		40 bar - 4 MPa				580 psi
Permissible Pressure		160 bar - 16 MPa				2300 psi
Rated Flow		20 - 60 l/min			5 - 16 USGpm	
Rated Temperature		0-90 °C				32-195 °F
Nozzle type						3 × 1/4 Npt
Rotational Speed						180 - 260 giri/min

Nozzles not included.
To choose the right part no., please fill in the selection questionnaire.

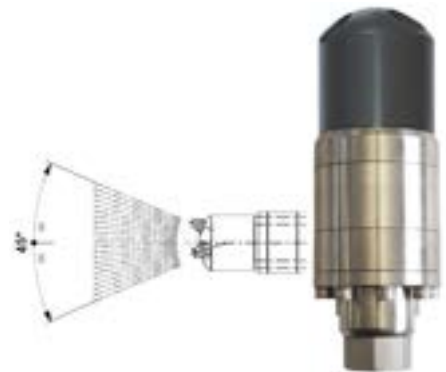

A43 FR 2- SELF-PROP.FRONT CLEANER - 3 NOZZLES - DIFFERENT SPRAY ANGLES

P/N	Rated Flow		Min. overall Ø		Weight			
	l/min	USGpm	mm	in	gr	oz		
25.5190.25	20-25	5-6,5	72	2,8	3244	114,42	1	
25.5190.26	25-30	6,5-8	72	2,8	3155	111,28	1	
25.5190.30	35-40	9-10,5	72	2,8	3152	111,17	1	
25.5190.34	45-50	12-13,2	72	2,8	3150	111,1	1	
25.5190.33	50-60	13,2-16	72	2,8	3144	110,89	1	

Inlet		1/2 Bsp F
Rated Pressure	140 bar - 14 MPa	2000 psi
Min. operating pressure	40 bar - 4 MPa	580 psi
Permissible Pressure	160 bar - 16 MPa	2300 psi
Rated Flow	20 - 60 l/min	5 - 16 USGpm
Rated Temperature	0-90 °C	32-195 °F
Nozzle type		3 × 1/4 Npt
Rotational Speed		180 - 260 giri/min

Nozzles not included.

To choose the right part no., please fill in the selection questionnaire.



A44 FR 2- SELF-PROP.FRONT CLEANER - 4 NOZZLES - DIFFERENT SPRAY ANGLES

P/N	Rated Flow		Min. overall Ø		Weight			
	l/min	USGpm	mm	in	gr	oz		
25.5400.30	35	9	72	2,8	3070	108,3	1	
25.5400.40	40	10,5	72	2,8	3070	108,3	1	
25.5400.60	50-60	13,2-16	72	2,8	3157	111,35	1	

Inlet		1/2 Bsp F
Rated Pressure	140 bar - 14 MPa	2000 psi
Min. operating pressure	40 bar - 4 MPa	580 psi
Permissible Pressure	160 bar - 16 MPa	2300 psi
Rated Flow	15 - 60 l/min	4 - 16 USGpm
Rated Temperature	0-90 °C	32-195 °F
Nozzle type		4 × 1/4 Npt
Rotational Speed		180 - 260 giri/min

Nozzles not included.

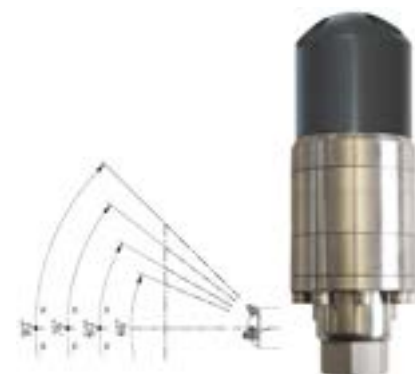
To choose the right part no., please fill in the selection questionnaire.

HOOK ATTACHMENT FOR TANK CLEANERS

P/N	Hole size		Type	Version	Weight			
	mm	in			gr	oz		
25.3301.53R	11	0,433	A 30	C	15	0,53	2	
25.4821.53R	11	0,433	A 80	B	15	0,53	2	
25.5562.53R	11	0,433	A300 - A 42	A	15	0,53	2	

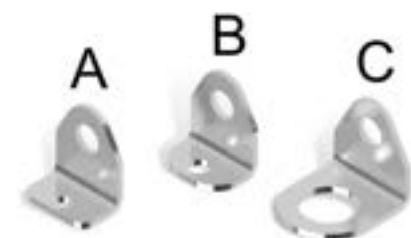

Material

Stainless steel Ai 304





TEFLON GREASE FOR TANK CLEANERS

P/N	Type	Weight			
		gr	oz		
14.6550.00R	Teflon grease	0	0	2	
14.6552.00R	Teflon silicon grease	0	0	2	



LP1 - STAINLESS STEEL FLOOR CLEANER

P/N	Width		Inlet	Gun type	Weight			
	mm	in			gr	oz		
29.0600.00	410	16	A M22	-	4321	152,41	1	✓

Spray gun not included

Rated Pressure	250 bar - 25 MPa	3650 psi
Permissible Pressure	280 bar - 28 MPa	4050 psi
Rated Flow	20 l/min	5,3 USGpm
Rated Temperature	160 °C	320 °F
Nozzle Size		06
Material		Stainless steel

Nozzles included



LPR8/2 - STAINLESS STEEL FLOOR CLEANER-ROTATING NOZZLES

P/N	Width		Inlet	Gun type	Weight			
	mm	in			gr	oz		
29.0700.10	450	17,72	3/8 Bsp F	RL 56	12200	430,3	1	✓

Rated Pressure	350 bar - 35 MPa	5100 psi
Permissible Pressure	390 bar - 39 MPa	5650 psi
Rated Flow	30 l/min	8 USGpm
Rated Temperature	80 °C	175 °F
Material		Stainless steel
Nozzle type		1/8 Npt M

Nozzles not included





FL7 - FLOW SWITCH WITH PROBE

P/N	Standing posit.*		Level posit.*		Weight			
	l/min	USGpm	l/min	USGpm	gr	oz		
28.0400.10	9	2,4	6	1,6	436	15,38	20	✓
28.0400.38	4	1,06	3	0,79	441	15,55	20	✓

Rated Pressure	350 bar - 35 MPa		5100 psi	
Permissible Pressure	390 bar - 39 MPa		5650 psi	
Max. flow rate on delivery	60 l/min		15.9 USGpm	
Max flow rate on feed side	30 l/min		7.9 USGpm	
Max. working temperature	75 °C		165 °F	
Max. Voltage	230 V			
Max.switch capacity	60 VA			
Max. Curr. Strength	3 A			
Electric cable	2x0,5 mmq.			
Cable length	1250 mm		49,2 in	
Electrical insulation	55 IP			
Inlet	3/8 Bsp F			
Outlet	3/8 Bsp F			

* Minimum operating flow rate



FL7 MS- FLOW SWITCH WITH PROBE

P/N	Standing posit.*		Weight			
	l/min	USGpm	gr	oz		
28.0430.00	0,3	0,1	455	16,05	5	✓

Rated Pressure	350 bar - 35 MPa		5100 psi	
Permissible Pressure	390 bar - 39 MPa		5650 psi	
Max. flow rate on delivery	60 l/min		15.9 USGpm	
Max flow rate on feed side	30 l/min		7.9 USGpm	
Max. working temperature	75 °C		165 °F	
Max. Voltage	230 V			
Max.switch capacity	60 VA			
Max. Curr. Strength	3 A			
Electric cable	2x0,5 mmq.			
Cable length	1250 mm		49,2 in	
Electrical insulation	55 IP			
Inlet	3/8 Bsp F			
Outlet	3/8 Bsp F			

* Minimum operating flow rate



FL7 INOX - FLOW SWITCH WITH PROBE-50 MPA



P/N	Standing posit.*		Level posit.*		Weight			
	l/min	USGpm	l/min	USGpm	gr	oz		
28.0450.00	9	2,4	6	1,6	430	15,17	5	✓

Rated Pressure	500 bar - 50 MPa		7300 psi	
Permissible Pressure	560 bar - 56 MPa		8120 psi	
Max flow rate on feed side	30 l/min		8 USGpm	
Max. flow rate on delivery	60 l/min		16 USGpm	
Max. working temperature	75 °C		165 °F	
Max. Voltage	230 V			
Max.switch capacity	60 VA			
Max. Curr. Strength	3 A			
Electric cable	2x0,5 mmq.			
Cable length	1250 mm		49,2 in	
Electrical insulation	55 IP			
Inlet	3/8 Bsp F			
Outlet	3/8 Bsp F			
Material	Stainless steel 303			

* Minimum operating flow rate



FL3 - FLOW SWITCH WITH PROBE



P/N	Shutter	Gauge bolt	Weight				
			gr	oz			
28.0500.10	Delrin	-	288	10,16	25		✓
28.0540.10	Brass	-	300	10,58	25		✓
Brass piston covering							
28.0530.10	Delrin	1x 1/4 Bsp F	308	10,86	25		✓
With 1/4 Bsp F gauge port							
28.0535.00	Brass	1x 1/4 Bsp F	318	11,22	25		✓
With 1/4 Bsp F gauge port							

Inlet		3/8 Bsp M
Outlet		3/8 Bsp M
Rated Pressure	250 bar - 25 MPa	3650 psi
Permissible Pressure	280 bar - 28 MPa	4050 psi
Rated Flow	30 l/min	8 USGpm
Level posit.*	3 l/min	0,8 USGpm
Standing posit.*	3 l/min	0,8 USGpm
Max. working temperature	75 °C	165 °F
Max. Voltage		230 V
Max. Curr. Strength		3 A
Max.switch capacity		60 VA
Electric cable		2x0,5 mmq.
Cable length	1250 mm	49,2 in
Electrical insulation		55 IP

*Minimum operating flow rate



FL 12 - FLOW SWITCH WITH PROBE

P/N	Standing posit.*		Level posit.*		Couplings	Weight				
	l/min	USGpm	l/min	USGpm		gr	oz			
28.0460.15	12,5	3,3	7,5	2	3/4 Bsp FF	975	34,4	4		
28.0460.00	12,5	3,3	7,5	2	3/4 F Npt	975	34,4	4		

Rated Pressure	280 bar - 28 MPa	4000 psi
Permissible Pressure	310 bar - 31 MPa	4500 psi
Max. flow rate on delivery	100 l/min	26,4 USGpm
Max flow rate on feed side	50 l/min	13,2 USGpm
Max. working temperature	75 °C	165 °F
Max. Voltage		230 V
Max.switch capacity		60 VA
Max. Curr. Strength		3 A
Electric cable		2x0,5 mmq.
Cable length	1250 mm	49,2 in
Electrical insulation		55 IP

* Minimum operating flow rate





PR5 - PRESSURE SWITCH

P/N	Inlet	Operat. press.		Col.	Weight			
		bar - MPa	psi		gr	oz		
29.0080.55	1/8 Bsp M	40 - 4	580	Black	136	4,8	50	✓
29.0080.18	1/8 Bsp M	25 - 2,5	360	Red	134	4,73	50	✓
29.0080.05	1/8 Bsp M	15 - 1,5	220	Blue	130	4,6	50	✓
29.0080.75	1/8 Bsp M	10 - 1	140	Yellow	138	4,87	50	✓
29.0080.50	1/4 Bsp M	40 - 4	580	Black	139	4,9	50	✓
29.0080.00	1/4 Bsp M	25 - 2,5	360	Red	137	4,83	50	✓
29.0080.10	1/4 Bsp M	15 - 1,5	220	Blue	137	4,83	50	✓
29.0080.80	3/8 Bsp M	40 - 4	580	Black	148	5,22	50	✓
29.0080.85	3/8 Bsp M	25 - 2,5	360	Red	145	5,11	50	✓
29.0080.88	3/8 Bsp M	15 - 1,5	220	Blue	146	5,15	50	✓

Permissible Pressure 350 bar - 35 MPa 5000 psi
 Rated Temperature 75 °C 165 °F
 Max. Voltage 250 V
 Max. Curr. Strength 6 (2) A
 Electrical insulation 55 IP
 Material Brass



PR16 - PRESSURE SWITCH WITH BRASS NIPPLE

P/N	Inlet	Operat. press.		Col.	Weight			
		bar - MPa	psi		gr	oz		
29.0040.20	1/4 Bsp M	40 - 4	580	Black	186	6,56	20	✓
29.0040.30	1/4 Bsp M	25 - 2,5	360	Red	186	6,56	20	✓
29.0040.40	1/4 Bsp M	15 - 1,5	220	Blue	189	6,67	20	✓
29.0040.00	3/8 Bsp M	40 - 4	580	Black	197	6,95	20	✓
29.0040.15	3/8 Bsp M	25 - 2,5	360	Red	195	6,88	20	✓
29.0040.11	3/8 Bsp M	15 - 1,5	220	Blue	196	6,91	20	✓

Permissible Pressure 350 bar - 35 MPa 5000 psi
 Rated Temperature 75 °C 165 °F
 Max. Voltage 250 V
 Max. Curr. Strength 16 (6) A
 Electrical insulation 55 IP
 Material Brass



PR16 - PRESSURE SWITCH WITH SST NIPPLE

P/N	Inlet	Operat. press.		Col.	Weight			
		bar - MPa	psi		gr	oz		
29.0035.30	1/4 Bsp M	40 - 4	580	Black	186	6,56	20	✓
29.0035.25	1/4 Bsp M	25 - 2,5	360	Red	184	6,49	20	✓
29.0035.10	3/8 Bsp M	40 - 4	580	Black	192	6,77	20	✓
29.0035.15	3/8 Bsp M	25 - 2,5	360	Red	194	6,84	20	✓
29.0035.50	1/4 Npt M	40 - 4	580	Black	186	6,56	20	✓
29.0035.52	1/4 Npt M	25 - 2,5	360	Red	189	6,67	20	✓
29.0035.51	1/4 Npt M	15 - 1,5	220	Blue	188	6,63	20	✓
29.0035.62	3/8 Npt M	25 - 2,5	360	Red	195	6,88	20	✓

Permissible Pressure 350 bar - 35 MPa 5000 psi
 Rated Temperature 75 °C 165 °F
 Max. Voltage 250 V
 Max. Curr. Strength 16 (6) A
 Electrical insulation 55 IP
 Material Stainless steel



PR1 - 600 BAR STAINLESS STEEL PRESSURE SWITCH 

P/N	Mat.	Operat. press.		Col.	Weight				
		bar - MPa	psi		gr	oz			
29.0010.00	St. steel	45 - 4,5	650	Black	216	7,7	20		✓
29.0010.25	St. steel	25 - 2,5	360	Red	216	7,7	20		✓

Inlet		3/8 Bsp M
Rated Pressure	600 bar - 60 MPa	8700 psi
Permissible Pressure	660 bar - 66 MPa	9570 psi
Rated Temperature	90 °C	195 °F
Max. Voltage		250 V
Max. Curr. Strength		16 (6) A
Electrical insulation		55 IP



THERMOSTAT WITH EXTERNAL PROBE

P/N	Length of coil		Probe		Weight				
	mm	in	mm	in	gr	oz			
12.5050.00	900	35,4	7 x 95	0,28 x 3,74	116	4,09	10		✓
Rated Temperature			120 °C		250 °F				
Max. Voltage					240 V				
Max. Curr. Strength					16 (6) A				



THERMOSTAT WITH INTERNAL PROBE

P/N	Length of coil		Probe		Weight				
	mm	in	mm	in	gr	oz			
12.5060.00	1500	59	7x95	0,28 x 3,74	146	5,15	10		✓
Couplings					M 14 x 1 M				
Rated Pressure			200 bar - 20 MPa		2880 psi				
Rated Temperature			120 °C		250 °F				
Max. Voltage					250 V				
Max. Curr. Strength					16(4) A				



PROBE CASE



P/N	Couplings	Hole size		Type	Weight				
		mm	in		gr	oz			
29.0250.00	1/2 Bspt M	7 x 90	0,27x 3,5	A	78	2,75	10		✓
Suitable for 12.5050.00									
29.0254.31R	1/2 Bspt M	M 14 x 1		B	47	1,66	10		✓
Suitable for 12.5060.00									

Material Brass





PS1 PROBE POCKET

P/N	Couplings	Weight			
		gr	oz		
29.0260.35R	3x3/8 Bsp F+1/2Bsp F	284	10,02	10	✓
Rated Pressure	280 bar - 28 MPa			4050 psi	
Permissible Pressure	310 bar - 31 MPa			4500 psi	
Rated Temperature	160 °C			320 °F	
Material				Brass	



STAINLESS STEEL LANCE HOLDER

P/N	No. of Ports	Hole size		Weight			
		mm	in	gr	oz		
28.0790.53R	5	16	0,63	378	13,33	5	✓
28.0794.53R	4	16	0,63	102	3,6	5	

Material Stainless steel Ai 304

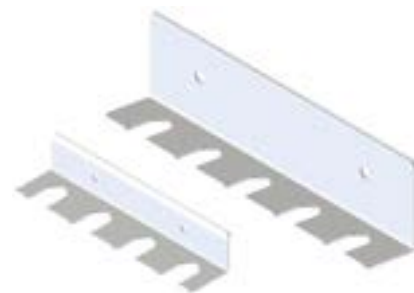

PLASTIC HIGH PRESSURE HOSE REEL -SST/BRASS

P/N	Type	Hose length		Mat.	Weight			
		m	yd		gr	oz		
29.0710.00	T 16	10	11	Brass	2800	98,8	1	✓
29.0720.00	T 26	20	22	Brass	3418	120,56	1	✓
29.0727.00	T 27	20	22	St. steel	3480	122,74	1	✓
29.0740.00	T 46	40	43,6	Brass	3826	134,95	1	✓
29.0747.00	T 47	40	43,6	St. steel	3866	136,36	1	✓

Inlet 3/8 Bsp M
 Hose Ø 20 mm 3/8 in
 Rated Pressure 250 bar - 25 MPa 3650 psi
 Permissible Pressure 280 bar - 28 MPa 4050 psi
 Rated Temperature 90 °C 195 °F

Hose not supplied
 Mat. Brass : Brass swivels and painted steel rest
 Mat. Sst : Sst swivel and rest



HIGH PRESSURE ALUMINIUM HOSE REEL

P/N	Type	Rated pr.		Inlet	Hose length		Hose Ø		Weight			
		bar - MPa	psi		m	yd	mm	in	gr	oz		
29.0360.00	T 52	300 - 30	4350	3/8 Bsp M	80	87,5	16,8	0,66	13000	458,52	1	✓
29.0375.00	T 53	200 - 20	2900	1/2 Bsp M	58	63,4	19,5	0,77	13000	458,52	1	✓
29.0390.00	T 100	200 - 20	2900	1/2 Bsp M	100	109	19,5	0,77	16400	578,44	1	

Rated Temperature 90 °C 195 °F

Hose not supplied



**BRASS ELBOW FITTINGS**

P/N	Inlet	Outlet	Weight		✓	✓
			gr	oz		
12.2000.00R	1/4 Bsp M	1/4 Bsp M	64	2,2	25	✓
12.2004.00R	1/4 Bsp M	1/4 Bsp F	76	2,68	25	✓
12.2002.00R	1/4 Bsp F	1/4 Bsp F	90	3,17	25	✓
12.2006.00R	3/8 Bsp M	3/8 Bsp M	70	2,47	25	✓
12.2010.00R	3/8 Bsp M	3/8 Bsp F	92	3,24	25	✓
12.2012.00R	3/8 Bsp M	1/4 Bsp M	64	2,26	25	✓
12.2014.00R	3/8 Bsp M	1/4 Bsp F	79	2,79	25	✓
12.2008.00R	3/8 Bsp F	3/8 Bsp F	112	3,95	25	✓
12.2020.00R	1/2 Bsp M	1/2 Bsp M	94	3,32	25	✓
12.2022.00R	1/2 Bsp M	3/8 Bsp F	118	4,1	25	✓
12.2024.00R	1/2 Bsp M	3/8 Bsp M	82	2,89	25	✓
12.2026.00R	1/2 Bsp M	1/4 Bsp M	75	2,65	25	✓

Rated Pressure
Material

350 bar - 35 MPa

5100 psi
Brass

**BRASS TII-FITTINGS**

P/N	Couplings	Weight		✓	✓
		gr	oz		
12.2050.00R	3/8 FF+F Bsp	161	5,68	25	✓
12.2050.10R	3/8 FF+F+1/8F Bsp	157	5,54	25	✓
12.2053.00R	3/8 MF+1/4 F Bsp	132	4,66	25	✓
12.2054.00R	3/8 MF+ F Bsp	138	4,87	25	✓
12.2055.00R	3/8 FF+M Bsp	139	4,9	25	✓
12.2058.00R	3/8 F-1/4 F+3/8 M Bsp	130	4,6	25	✓

Rated Pressure
Material

350 bar - 35 MPa

5100 psi
Brass

**SST ELBOW FITTINGS AI303 -60MPA**

P/N	Inlet	Outlet	Type	Weight		✓	✓
				gr	oz		
12.3000.55R	3/8 Bsp F	3/8 Bsp F	A	144	5,08	5	✓
12.3001.55R	1/2 Bsp F	1/2 Bsp F	B	237	8,36	5	✓

Rated Pressure
Material

600 bar - 60 MPa

8760 psi
Stainless steel 303

**SST TII-FITTINGS TII -AI303 - 60MPA**

P/N	Couplings	Type	Weight		✓	✓
			gr	oz		
12.3050.55R	3/8 FF+F Bsp	A	208	7,34	5	✓
12.3051.55R	1/2 Bsp FF+F	B	334	11,78	5	✓



Rated Pressure
Material

600 bar - 60 MPa

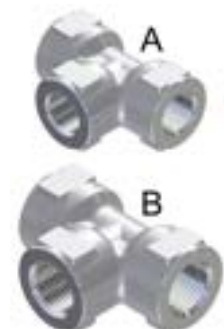
8760 psi
Stainless steel 303



ZINC PLATED COUPLINGS AND HOSE BARB FITTINGS

P/N	Inlet	Outlet	Weight			
			gr	oz		
13.5006.00R	1/4 Bsp M	1/4 Bsp M	26	0,92	25	✓
40.5002.61R	1/4 Bsp M	1/4 Bsp F	41	1,4	10	
13.5011.00R	1/4 Bsp M	3/8 Bsp M	42	1,4	25	✓
13.5007.00R	1/4 Bsp F	1/4 Bsp F	24	0,8	25	✓
13.5025.00R	3/8 Bsp M	3/8 Bsp M	42	1,48	25	✓
13.5030.00R	3/8 Bsp M	1/2 Bsp M	72	2,54	25	✓
13.5031.00R	1/2 Bsp M	1/2 Bsp M	72	2,5	25	✓
13.5008.08R	3/8 Bsp M	8mm hose barb	42	1,48	25	
40.0006.61R	1/4 Npt M	1/4 Bsp F	41	1,4	10	

Rated Pressure 250 bar - 25 MPa 3650 psi
Material Zinc plated steel





BRASS COUPLINGS AND HOSE BARB FITTINGS

P/N	Inlet	Outlet	Weight			
			gr	oz		
40.5008.31R	1/4 Bsp M	1/4 Bsp F	44	1,5	10	
26.0036.31R	1/4 Bsp F	3/8 Bsp M	44	1,5	10	✓
26.0037.31R	1/4 Bsp F	3/8 Bsp F	44	1,5	10	✓
13.5027.31R	3/8 Bsp F	1/4 Bsp M	44	1,5	25	✓
13.5024.31R	3/8 Bsp M	3/8 Bsp M	40	1,41	25	✓
29.0103.31R	1/8 Bsp M	8mm hose barb	20	0,7	10	

Rated Pressure 250 bar - 25 MPa 3650 psi
Material Brass





STAINLESS STEEL COUPLINGS

P/N	Inlet	Outlet	Weight			
			gr	oz		
40.5002.51R	1/4 Bsp F	1/4 Bsp M	41	1,4	10	
40.0007.51R	1/4 Bsp F	1/4 Npt F	23	0,8	10	✓
40.0251.51R	1/4 Bsp F	1/4 Bsp M	41	1,4	5	
40.0252.51R	1/4 Bsp F	1/4 Npt M	41	1,4	5	
13.5009.51R	1/4 Bsp M	1/4 Npt M	44	1,5	5	✓
26.0232.51R	1/4 Bsp F	3/8 Bsp F	41	1,4	5	
13.5025.51R	3/8 Bsp M	3/8 Bsp M	44	1,5	5	✓

Rated Pressure 250 bar - 25 MPa 3650 psi
Material Stainless steel



STAINLESS STEEL COUPLINGS-60MPA

P/N	Inlet	Outlet	Type	Weight			
				gr	oz		
13.5050.51R	1/4 Bsp M	1/4 Bsp M	A	34	1,2	5	✓
13.5051.51R	3/8 Bsp M	3/8 Bsp M	B	52	1,83	5	✓
13.5052.51R	1/2 Bsp M	1/2 Bsp M	C	88	3,1	5	✓
13.5060.51R	1/4 Bsp M	3/8 Bsp M	D	44	1,55	5	✓
13.5061.51R	3/8 Bsp M	1/2 Bsp M	E	78	2,75	5	✓
13.5062.51R	3/8 Bsp M	1/4 Npt M	F	46	1,62	5	
13.5070.51R	1/4 Bsp F	3/8 Bsp M	G	55	1,94	5	✓
13.5071.51R	1/4 Bsp F	1/2 Bsp M	H	96	3,39	5	
13.5072.51R	3/8 Bsp F	1/2 Bsp M	L	94	3,32	5	

Rated Pressure 600 bar - 60 MPa 8760 psi
Material Stainless steel 303





BRASS PLUGS AND GRUB SCREWS

P/N	Couplings	Type	Weight		25	✓
			gr	oz		
28.0013.31R	1/4 Bsp	Hex.17	18	0,65	25	✓
60.0022.31R	1/4 Bsp	Grub screw	4	0,14	5	
60.0028.31R	3/8 Bsp	Hex.19	18	0,65	25	
60.0413.31R	1/2 Bsp	Hex.27	51	1,8	10	
60.0026.31R	1/4 Npt M	Grub screw	4	0,14	1	
60.0025.31R	3/8 Npt M	Grub screw	4	0,14	10	
60.0444.31R	1/2 Npt	Grub screw	24	0,9	10	
21.0199.31R	M 12 × 1 mm	Grub screw	4	0,14	5	

Rated Pressure 250 bar - 25 MPa 3650 psi
Material Brass



STAINLESS STEEL PLUGS AND GRUB SCREWS

P/N	Couplings	Type	Weight		3 <th rowspan="2">4 <th rowspan="2">10 <th rowspan="2">1 <th rowspan="2">3 <th rowspan="2">5 </th></th></th></th></th>	4 <th rowspan="2">10 <th rowspan="2">1 <th rowspan="2">3 <th rowspan="2">5 </th></th></th></th>	10 <th rowspan="2">1 <th rowspan="2">3 <th rowspan="2">5 </th></th></th>	1 <th rowspan="2">3 <th rowspan="2">5 </th></th>	3 <th rowspan="2">5 </th>	5
			gr	oz						
60.0413.51R	1/2 Bsp	Hex.27	56	2	3					
15.3711.18R	1/8 Npt M	Grub screw	9	0,3	4					
15.3721.14R	1/4 Npt M	Grub screw	18	0,6	10					
60.0444.51R	1/2 Npt	Grub screw	22	0,8	1					
60.0444.60R	1/2 Npt	Grub screw	22	0,8	3					
Ai 316										
60.0552.51R	M 24 × 1,5 M	Hex.27	88	3,1	5					

Rated Pressure 250 bar - 25 MPa 3650 psi
Material Stainless steel



FILLER AND CAP FOR GAS OIL

P/N	Type	Hole size		Length		Material	Weight		25	✓
		mm	in.	mm	in.		gr	oz		
29.0197.84R	Fillercap	39	1,54	-	-	PE	22	0,78	25	✓
29.0196.66R	Filler	39	1,54	70	2,76	Steel	76	2,68	25	✓
29.0198.66R	Filler	39	1,54	105	4,13	Steel	120	4,2	25	





PULSATION DAMPENERS

P/N	Volume		Pump flow rate		Inlet	Type	Weight		1	✓
	L	USg	l/min	USGpm			gr	oz		
29.0200.05R	0,1	0,026	15 - 21	4 - 5,5	3/8 Npt F	A	874	30,83	1	✓
29.0202.05R	0,35	0,093	30 - 41	7,9 - 10,8	1/2 Npt F	B	1768	62,36	1	✓

Rated Pressure 210 bar - 21 MPa 3050 psi
Charge press. 40 bar - 4 MPa 580 psi
Rated Temperature 80 °C 176 °F



PRESSURE GAUGE - ND 63 

P/N	Scale bar - MPa	Inlet	Type	Version	Weight				
					gr	oz			
13.0025.16R	160 - 16	1/4 Bspt M	Radial	B	155	5,46	20		✓
13.0025.25R	250 - 25	1/4 Bspt M	Radial	B	148	5,22	20		✓
13.0025.31R	315 - 31,5	1/4 Bspt M	Radial	B	154	5,43	20		✓
13.0025.40R	400 - 40	1/4 Bspt M	Radial	B	148	5,22	20		✓
13.0035.16R	160 - 16	1/4 Bspt M	Back entry	A	168	5,93	20		✓
13.0035.25R	250 - 25	1/4 Bspt M	Back entry	A	170	6	20		✓
13.0035.31R	315 - 31,5	1/4 Bspt M	Back entry	A	168	5,93	20		✓
13.0035.40R	400 - 40	1/4 Bspt M	Back entry	A	168	5,93	20		✓

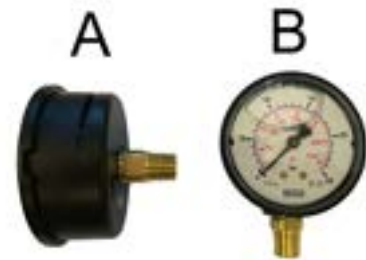

Case ABS



B5 - PUMPS' GEARBOX

P/N	Drive shaft Ø		Pump shaft Ø		Weight		5		
	mm	in	mm	in	gr	oz			
50.0600.00	19,05	3/4"	24	0,9449	2048	72,23	5		
Gear ratio					2,3 : 1				
Engine power					4,8 kw		6,5 hp		
Oil capacity					0,15 l		4,5 oz		

Lubricating oil : Sae 90
 Engine flange : Sae J609a
 Pumps : AR-Bertolini-Comet-Interpump-Leuco-Hawk-Udor



B18 - PUMPS' GEARBOX

P/N	Drive shaft Ø		Pump shaft Ø		Weight		5		
	mm	in	mm	in	gr	oz			
50.0000.00	25,4	1"	24	0,9449	3841	135,47	5		
50.0090.00	25,4	1"	24	0,9449	3841	135,47	5		
Pumps: IP EVO 2- Speck NP10-15-16									
50.0040.00	28,6	1" 1/8	24	0,9449	3765	132,79	5		
50.0000.25	25,0	0,984	24	0,9449	3809	134,35	5		
50.0015.00	25,4	1"	25	0,984	3902	137,63	5		
Pumps : Leuco LT-XLT									

Gear ratio 2,176 : 1
 Engine power 8 - 13 kw 11 - 18 hp
 Oil capacity 0,35 l 10 oz

Lubricating oil : Sae 90
 Engine flange : Sae J609b
 Pumps: AR-Bertolini-Comet-Interpump-Leuco-Hawk-Udor



B18H - PUMPS' GEARBOX

P/N	Drive shaft Ø		Pump shaft Ø		Weight		5		
	mm	in	mm	in	gr	oz			
50.0050.00	25,4	1"	24	0,9449	4304	151,81	5		
Gear ratio					2,176 : 1				
Engine power					8 - 13 kw		11 - 18 hp		
Oil capacity					0,35 l		10 oz		

Lubricating oil : Sae 90
 Engine flange : Sae J609b
 Pumps: AR-Bertolini-Comet-Interpump-Leuco-Hawk-Udor



B24 - PUMPS' GEARBOX

P/N	Drive shaft Ø		Pump shaft Ø		Weight			
	mm	in	mm	in	gr	oz		
50.0060.00	28,6	1"1/8	24	0,9449	3768	132,9	5	✓
50.0062.00	25,4	1"	24	0,9449	3862	136,22	5	✓
50.0062.25	25,4	1"	28	1,10	3862	136,22	5	
50.0064.00	28,6	1"1/8	25	0,9842	3759	132,58	5	✓

Gear ratio 2,176 : 1
 Engine power 13-17 kw 18-24 hp
 Oil capacity 0,35 l 10 oz

Lubricating oil : Sae 90
 Engine flange : Sae J609b
 Pumps: AR-Bertolini-Comet-Interpump-Leuco-Hawk-Udor



B31 - PUMPS' GEARBOX

P/N	Drive shaft Ø		Pump shaft Ø		Weight			
	mm	in	mm	in	gr	oz		
50.0071.00	28,6	1"1/8	24	0,9449	3804	134,17	5	✓
50.0071.30	28,6	1"1/8	30	1,181	3732	131,63	5	✓

Gear ratio 2,176 : 1
 Engine power 17-23 kw 24-31 hp
 Oil capacity 0,35 l 10 oz

Lubricating oil : Sae 90
 Engine flange : Sae J609b
 Pumps: AR-Bertolini-Comet-Interpump-Leuco-Hawk-Udor



B34 - PUMPS' GEARBOX 25KW **NEW**

P/N	Drive shaft Ø		Pump shaft Ø		Weight			
	mm	in	mm	in	gr	oz		
50.0310.00	28,6	1"1/8	28	1,102	6980	246,2	5	
50.0360.00	28,6	1"1/8	30	1,181	6980	246,2	1	

Gear ratio 2,21 : 1
 Engine power 23-25 kw 31-34 hp
 Oil capacity 0,5 l 17 oz

Lubricating oil : Sae 90 - Engine flange : Sae J609b - Pumps: Comet- Pratisoli



B40 -29,4 KW PUMPS' GEARBOX **NEW**

P/N	Drive shaft Ø		Pump shaft Ø		Weight			
	mm	in	mm	in	gr	oz		
50.0410.00	28,6	1"1/8	28	1,102	6980	246,2	1	
50.0415.00	28,6	1"1/8	30	1,181	6980	246,2	1	
50.0450.00	28,6	1"1/8	30	1,181	6980	246,2	5	

Gear ratio 2,21 : 1
 Engine power 23-29,4 kw 31-40 hp
 Oil capacity 0,5 l 17 oz

Lubricating oil : Sae 90 - Engine flange : Sae J609b - Pumps: Comet - Pratisoli (KT-KE)



**TABELLA RIEPILOGATIVA PORTAUGELLI SPECIALI
SPECIAL NOZZLES CHART**

★ Tutti gli ugelli PA sono forniti con tolleranze di ±5% sui dati riportati nella tabella
★ All PA nozzles are supplied with a ±5% tolerance on data reported in this table

Fatt. Port. Capac. Size	Colore Color	★ ↓	Portata (l/min) a 100 bar - 10 MPa Flow rate (GPM) at 1450 PSI														★ ↓	Fatt. Port. Capac. Size	Colore Color					
			HL250	HL280	VAN	VAN250	UR1		UR3		UR16	UR25	UR32	UR20		UR35				UR50	TS2	TS3	TS8	
							Monot.	Biturbo	Monot.	Biturbo	GAS	GAS	GAS	GAS	NPT	GAS				NPT				
O2	Verde chiaro Light green	4,6 1,2	25.0700.10	25.0950.10											25.1720.20		25.1735.20				25.0000.10	4,6 1,2	O2	Verde chiaro Light green
O23	Giallo chiaro Light yellow	5,0 1,3		25.0950.11																		5,0 1,3	O23	Giallo chiaro Light yellow
O25	Rosa Pink	5,7 1,5	25.0700.11		25.0900.10	25.0850.11				25.1680.25										25.0080.11		5,7 1,5	O25	Rosa Pink
O27	Nero Black	6,1 1,6																				6,1 1,6	O27	Nero Black
O3	Bianco White	6,8 1,8	25.0700.12	25.0950.12	25.0900.11	25.0850.12	25.1100.11			25.1680.30	25.1620.30	25.1690.30	25.1720.30	25.1700.30	25.1735.30			25.0020.12	25.0080.12	25.0000.12		6,7 1,8	O3	Bianco White
O32	Viola scuro Dark purple	7,1 1,9	25.0700.25																			7,1 1,9	O32	Viola scuro Dark purple
O35	Marrone Brown	8,0 2,1	25.0700.13	25.0950.13	25.0900.12	25.0850.13	25.1100.12		25.1148.12	25.1680.35	25.1620.35	25.1690.35	25.1720.35	25.1700.35	25.1735.35	25.1935.35						8,0 2,1	O35	Marrone Brown
O37	Rosso chiaro Light red	8,4 2,2	25.0700.35																			8,4 2,2	O37	Rosso chiaro Light red
O4	Giallo scuro Dark yellow	9,1 2,4	25.0700.14	25.0950.14	25.0900.13	25.0850.14	25.1100.13			25.1680.40	25.1620.40	25.1690.40	25.1720.40	25.1700.40	25.1735.40		25.1750.40	25.0020.14	25.0080.14	25.0000.14		9,1 2,4	O4	Giallo scuro Dark yellow
O43	Grigio scuro Dark gray	9,7 2,6	25.0700.45																			9,7 2,6	O43	Grigio scuro Dark gray
O45	Blu Blue	10,3 2,7	25.0700.15	25.0950.15	25.0900.14	25.0850.15	25.1100.14		25.1148.14	25.1680.45	25.1620.45	25.1690.45	25.1720.45	25.1700.45	25.1735.45	25.1935.45	25.1750.45	25.0020.15	25.0080.15	25.0000.15		10,3 2,7	O45	Blu Blue
O5	Viola chiaro Light purple	11,4 3,0	25.0700.55				25.1100.15		25.1150.10	25.1680.50	25.1620.50	25.1690.50	25.1720.50		25.1735.50		25.1750.50	25.0020.16		25.0000.16		11,4 3,0	O5	Viola chiaro Light purple
O53	Beige Beige	12,0 3,2	25.0700.16	25.0950.16		25.0850.16																12,0 3,2	O53	Beige Beige
O55	Rosso scuro Dark red	12,5 3,3	25.0700.65	25.0950.55	25.0900.15			25.1148.16		25.1680.55	25.1620.55	25.1690.55	25.1720.55	25.1700.55	25.1735.55	25.1935.55	25.1750.55					12,6 3,3	O55	Rosso scuro Dark red
O6	Verde scuro Dark green	13,7 3,6	25.0700.66	25.0950.60	25.0900.16		25.1100.16		25.1148.17	25.1680.60	26.1620.60	25.1690.60	25.1720.60		25.1735.60		25.1750.60					13,7 3,6	O6	Verde scuro Dark green
O65	Celeste Light blue	14,8 3,9	25.0700.72							25.1680.65	25.1620.65	25.1690.65	25.1720.65	25.1700.65	25.1735.65	25.1935.65	25.1750.65					14,8 3,9	O65	Celeste Light blue
O7	Arancio Orange	16,0 4,2	25.0700.18	25.0950.18					25.1150.12	25.1680.70	25.1620.70	25.1690.70	25.1720.70	25.1700.70			25.1750.70					16,0 4,2	O7	Arancio Orange
O75		17,1 4,5																			25.0000.18	17,1 4,5	O75	
O8	Argento Silver	18,2 4,8	25.0700.20		25.0900.18			25.1100.17		25.1150.13		25.1620.80	25.1690.80		25.1735.80							18,2 4,8	O8	Argento Silver
O85	Bianco-Rosa White-Rose	19,4 5,1																			25.0000.20	19,4 5,1	O85	Bianco-Rosa White-Rose
O9	Oro Gold	21,0 5,5		25.0950.22			25.1100.18		25.1150.14						25.1735.90	25.1935.90						21,0 5,5	O9	Oro Gold
10	Bianco-Blu White-Blue	23,0 6,1							25.1150.15						25.1735.10							23,0 6,1	10	Bianco-Blu White-Blue
12	Bianco-Giallo White-Yellow	27,0 7,1		25.0950.24					25.1150.17						25.1735.12							27,0 7,1	12	Bianco-Giallo White-Yellow
13	Bianco-Verde White-Green	30,0 7,9			25.0900.23																	30,0 7,9	13	Bianco-Verde White-Green
20	Bianco-Rosso White-Red	46,0 12,2			25.0900.28																	46,0 12,2	20	Bianco-Rosso White-Red

Fattore di Portata		Portata (l/min) alla Pressione (bar)																				Fattore di Portata	
Capacity Size		Flow rate (GPM) at Pressure (PSI)																				Capacity Size	
bar MPa PSI		1 0,1 15	2 0,2 29	3 0,3 44	4 0,4 58	5 0,5 73	6 0,6 87	7 0,7 102	8 0,8 116	9 0,9 131	10 1 145	15 1,5 218	20 2 290	25 2,5 363	30 3 435	40 4 580	50 5 725	60 6 870	bar MPa PSI				
01		0,2	0,3	0,4	0,5	0,5	0,6	0,6	0,7	0,7	0,7	0,9	1,0	1,2	1,3	1,5	1,6	1,8		01			
015		0,3	0,5	0,6	0,7	0,8	0,8	0,9	1,0	1,0	1,1	1,3	1,5	1,7	1,9	2,2	2,4	2,6		015			
02		0,5	0,7	0,8	0,9	1,0	1,1	1,2	1,3	1,4	1,5	1,8	2,1	2,3	2,5	2,9	3,3	3,6		02			
023*		0,5	0,7	0,9	1,0	1,1	1,2	1,3	1,4	1,5	1,6	1,9	2,2	2,5	2,7	3,2	3,5	3,9		023*			
025*		0,6	0,8	1,0	1,1	1,3	1,4	1,5	1,6	1,7	1,8	2,2	2,5	2,8	3,1	3,5	4,0	4,3		025*			
027*		0,6	0,9	1,1	1,2	1,4	1,5	1,6	1,7	1,8	1,9	2,4	2,7	3,1	3,3	3,9	4,3	4,7		027*			
03		0,7	1,0	1,2	1,4	1,5	1,7	1,8	1,9	2,0	2,2	2,6	3,0	3,4	3,7	4,3	4,8	5,3		03			
032*		0,7	1,0	1,2	1,4	1,6	1,7	1,9	2,0	2,1	2,2	2,7	3,2	3,6	3,9	4,5	5,0	5,5		032*			
035*		0,8	1,1	1,4	1,6	1,8	2,0	2,1	2,3	2,4	2,5	3,1	3,6	4,0	4,4	5,1	5,7	6,2		035*			
037*		0,8	1,2	1,5	1,7	1,9	2,1	2,2	2,4	2,5	2,7	3,3	3,8	4,2	4,6	5,3	5,9	6,5		037*			
04		0,9	1,3	1,6	1,8	2,0	2,2	2,4	2,6	2,7	2,9	3,5	4,1	4,6	5,0	5,8	6,4	7,0		04			
043*		1,0	1,4	1,7	1,9	2,2	2,4	2,6	2,7	2,9	3,1	3,8	4,3	4,9	5,3	6,1	6,9	7,5		043*			
045		1,0	1,5	1,8	2,1	2,3	2,5	2,7	2,9	3,1	3,3	4,0	4,6	5,2	5,6	6,5	7,3	8,0		045			
05		1,1	1,6	2,0	2,3	2,5	2,8	3,0	3,2	3,4	3,6	4,4	5,1	5,7	6,2	7,2	8,1	8,8		05			
053*		1,2	1,7	2,1	2,4	2,7	2,9	3,2	3,4	3,6	3,8	4,6	5,4	6,0	6,6	7,6	8,5	9,3		053*			
055		1,3	1,8	2,2	2,5	2,8	3,1	3,3	3,5	3,8	4,0	4,8	5,6	6,3	6,8	7,9	8,8	9,5		055			
06		1,4	1,9	2,4	2,7	3,1	3,4	3,6	3,9	4,1	4,3	5,3	6,1	6,9	7,5	8,7	9,7	10,6		06			
065		1,5	2,1	2,6	3,0	3,3	3,6	3,9	4,2	4,4	4,7	5,7	6,6	7,4	8,1	9,4	10,5	11,5		065			
07		1,6	2,3	2,8	3,2	3,6	3,9	4,2	4,5	4,8	5,1	6,2	7,2	8,0	8,8	10,1	11,3	12,4		07			
075		1,7	2,4	3,0	3,4	3,8	4,2	4,5	4,8	5,1	5,4	6,6	7,6	8,6	9,4	10,8	12,1	13,2		075			
08		1,8	2,6	3,2	3,6	4,1	4,5	4,8	5,1	5,5	5,8	7,0	8,1	9,1	10,0	11,5	12,9	14,1		08			
085		1,9	2,7	3,4	3,9	4,3	4,8	5,1	5,5	5,8	6,1	7,5	8,7	9,7	10,6	12,3	13,7	15,0		085			
09		2,1	3,0	3,6	4,2	4,7	5,1	5,6	5,9	6,3	6,6	8,1	9,4	10,5	11,5	13,3	14,8	16,0		09			
095		2,2	3,1	3,8	4,4	4,9	5,4	5,8	6,2	6,6	7,0	8,5	9,8	11,0	12,0	13,9	15,6	17,0		095			
10		2,3	3,3	4,0	4,6	5,1	5,6	6,1	6,5	6,9	7,3	8,9	10,3	11,5	12,6	14,5	16,3	17,8		10			
11		2,5	3,5	4,3	5,0	5,6	6,1	6,6	7,1	7,5	7,9	9,7	11,2	12,5	13,7	15,8	17,7	19,4		11			
115		2,6	3,7	4,5	5,2	5,8	6,4	6,9	7,4	7,8	8,2	10,1	11,6	13,0	14,2	16,4	18,4	20,1		115			
12		2,7	3,8	4,7	5,4	6,0	6,6	7,1	7,6	8,1	8,5	10,5	12,1	13,5	14,8	17,1	19,1	20,9		12			
125		2,8	4,0	4,8	5,6	6,3	6,9	7,4	7,9	8,4	8,9	10,8	12,5	14,0	15,3	17,7	19,8	21,7		125			
13		3,0	4,2	5,2	6,0	6,7	7,3	7,9	8,5	9,0	9,5	11,6	13,4	15,0	16,4	19,0	21,2	23,2		13			
14		3,2	4,5	5,5	6,4	7,2	7,8	8,5	9,1	9,6	10,1	12,4	14,3	16,0	17,5	20,2	22,6	24,8		14			
15		3,4	4,8	5,9	6,8	7,6	8,3	9,0	9,6	10,2	10,8	13,2	15,2	17,0	18,6	21,5	24,0	26,3		15			
16		3,6	5,1	6,2	7,2	8,0	8,8	9,5	10,2	10,8	11,4	13,9	16,1	18,0	19,7	22,8	25,5	27,9		16			
18		4,1	5,8	7,1	8,2	9,2	10,0	10,8	11,6	12,3	13,0	15,9	18,3	20,5	22,5	25,9	29,0	31,8		18			
19		4,3	6,1	7,4	8,6	9,6	10,5	11,4	12,2	12,9	13,6	16,7	19,2	21,5	23,6	27,2	30,4	33,3		19			
20		4,6	6,5	8,0	9,2	10,3	11,3	12,2	13,0	13,8	14,5	17,8	20,6	23,0	25,2	29,1	32,5	35,6		20			
25		5,7	8,1	9,9	11,4	12,7	14,0	15,1	16,1	17,1	18,0	22,1	25,5	28,5	31,2	36,0	40,3	44,2		25			
30		6,8	9,6	11,8	13,6	15,2	16,7	18,0	19,2	20,4	21,5	26,3	30,4	34,0	37,2	43,0	48,1	52,7		30			
35		8,0	11,3	13,9	16,0	17,9	19,6	21,2	22,6	24,0	25,3	31,0	35,8	40,0	43,8	50,6	56,6	62,0		35			
40		9,1	12,9	15,8	18,2	20,3	22,3	24,1	25,7	27,3	28,8	35,2	40,7	45,5	49,8	57,6	64,3	70,5		40			
50		11,4	16,1	19,7	22,8	25,5	27,9	30,2	32,2	34,2	36,0	44,2	51,0	57,0	62,4	72,1	80,6	88,3		50			
60		13,7	19,4	23,7	27,4	30,6	33,6	36,2	38,7	41,1	43,3	53,1	61,3	68,5	75,0	86,6	96,9	106,1		60			
70		16,0	22,6	27,7	32,0	35,8	39,2	42,3	45,3	48,0	50,6	62,0	71,6	80,0	87,6	101,2	113,1	123,9		70			
80		18,2	25,7	31,5	36,4	40,7	44,6	48,2	51,5	54,6	57,6	70,5	81,4	91,0	99,7	115,1	128,7	141,0		80			
90		20,5	29,0	35,5	41,0	45,8	50,2	54,2	58,0	61,5	64,8	79,4	91,7	102,5	112,3	129,7	145,0	158,8		90			
	bar MPa PSI	1 0,1 15	2 0,2 29	3 0,3 44	4 0,4 58	5 0,5 73	6 0,6 87	7 0,7 102	8 0,8 116	9 0,9 131	10 1 145	15 1,5 218	20 2 290	25 2,5 363	30 3 435	40 4 580	50 5 725	60 6 870	bar MPa PSI				

* F.P. UGELLI SPECIALI

Tutti gli ugelli PA sono forniti con tolleranze di ±5% sui dati riportati nella tabella
All PA nozzles are supplied with a ±5% tolerance on data reported in this table

* F.P. UGELLI SPECIALI

Tutti gli ugelli PA sono forniti con tolleranze di ±5% sui dati riportati nella tabella
All PA nozzles are supplied with a ±5% tolerance on data reported in this table

Fattore di Portata		Portata (l/min) alla Pressione (bar)																				Fattore di Portata	
Capacity Size		Flow rate (GPM) at Pressure (PSI)																				Capacity Size	
	bar MPa PSI	70 8 1015	80 9 1160	90 10 1305	100 11 1450	110 12 1595	120 13 1740	130 14 1885	140 15 2030	150 16 2175	160 17 2320	170 18 2465	180 19 2610	190 20 2755	200 21 2900	210 22 3045	220 23 3190	230 24 3335	bar MPa PSI				
01		1,9	2,1	2,2	2,3	2,4	2,5	2,6	2,7	2,8	2,9	3,0	3,1	3,2	3,3	3,3	3,4	3,5		01			
015		2,8	3,0	3,2	3,4	3,6	3,7	3,9	4,0	4,2	4,3	4,4	4,6	4,7	4,8	4,9	5,0	5,2		015			
02		3,8	4,1	4,4	4,6	4,8	5,0	5,2	5,4	5,6	5,8	6,0	6,2	6,3	6,5	6,7	6,8	7,0		02			
023*		4,2	4,5	4,7	5,0	5,2	5,5	5,7	5,9	6,1	6,3	6,5	6,7	6,9	7,1	7,2	7,4	7,6		023*			
025*		4,7	5,0	5,3	5,6	5,9	6,1	6,4	6,6	6,9	7,1	7,3	7,5	7,7	7,9	8,1	8,3	8,5		025*			
027*		5,1	5,5	5,8	6,1	6,4	6,7	7,0	7,2	7,5	7,7	8,0	8,2	8,4	8,6	8,8	9,0	9,3		027*			
03		5,7	6,1	6,5	6,8	7,1	7,4	7,8	8,0	8,3	8,6	8,9	9,1	9,4	9,6	9,9	10,1	10,3		03			
032*		5,9	6,4	6,7	7,1	7,4	7,8	8,1	8,4	8,7	9,0	9,3	9,5	9,8	10,0	10,3	10,5	10,8		032*			
035*		6,7	7,2	7,6	8,0	8,4	8,8	9,1	9,5	9,8	10,1	10,4	10,7	11,0	11,3	11,6	11,9	12,1		035*			
037*		7,0	7,5	8,0	8,4	8,8	9,2	9,6	9,9	10,3	10,6	11,0	11,3	11,6	11,9	12,2	12,5	12,7		037*			
04		7,6	8,1	8,6	9,1	9,5	10,0	10,4	10,8	11,1	11,5	11,9	12,2	12,5	12,9	13,2	13,5	13,8		04			
043*		8,1	8,7	9,2	9,7	10,2	10,6	11,1	11,5	11,9	12,3	12,6	13,0	13,4	13,7	14,1	14,4	14,7		043*			
045		8,6	9,2	9,8	10,3	10,8	11,3	11,7	12,2	12,6	13,0	13,4	13,8	14,2	14,6	14,9	15,3	15,6		045			
05		9,5	10,2	10,8	11,4	12,0	12,5	13,0	13,5	14,0	14,4	14,9	15,3	15,7	16,1	16,5	16,9	17,3		05			
053*		10,0	10,7	11,4	12,0	12,6	13,1	13,7	14,2	14,7	15,2	15,6	16,1	16,5	17,0	17,4	17,8	18,2		053*			
055		10,5	11,2	11,9	12,5	13,1	13,7	14,3	14,8	15,3	15,8	16,3	16,8	17,2	17,7	18,1	18,5	19,0		055			
06		11,5	12,3	13,0	13,7	14,4	15,0	15,6	16,2	16,8	17,3	17,9	18,4	18,9	19,4	19,9	20,3	20,8		06			
065		12,4	13,2	14,0	14,8	15,5	16,2	16,9	17,5	18,1	18,7	19,3	19,9	20,4	20,9	21,4	22,0	22,4		065			
07		13,4	14,3	15,2	16,0	16,8	17,5	18,2	18,9	19,6	20,2	20,9	21,5	22,1	22,6	23,2	23,7	24,3		07			
075		14,3	15,3	16,2	17,1	17,9	18,7	19,5	20,2	20,9	21,6	22,3	22,9	23,6	24,2	24,8	25,4	25,9		075			
08		15,2	16,3	17,3	18,2	19,1	19,9	20,8	21,5	22,3	23,0	23,7	24,4	25,1	25,7	26,4	27,0	27,6		08			
085		16,2	17,4	18,4	19,4	20,3	21,3	22,1	23,0	23,8	24,5	25,3	26,0	26,7	27,4	28,1	28,8	29,4		085			
09		17,6	18,8	19,9	21,0	22,0	23,0	23,9	24,8	25,7	26,6	27,4	28,2	28,9	29,7	30,4	31,1	31,8		09			
095		18,4	19,7	20,9	22,0	23,1	24,1	25,1	26,0	26,9	27,8	28,7	29,5	30,3	31,1	31,9	32,6	33,4		095			
10		19,2	20,6	21,8	23,0	24,1	25,2	26,2	27,2	28,2	29,1	30,0	30,9	31,7	32,5	33,3	34,1	34,9		10			
11		20,9	22,4	23,7	25,0	26,2	27,4	28,5	29,6	30,6	31,6	32,6	33,5	34,5	35,4	36,2	37,1	37,9		11			
115		21,8	23,3	24,7	26,0	27,3	28,5	29,6	30,8	31,8	32,9	33,9	34,9	35,8	36,8	37,7	38,6	39,4		115			
12		22,6	24,1	25,6	27,0	28,3	29,6	30,8	31,9	33,1	34,2	35,2	36,2	37,2	38,2	39,1	40,0	40,9		12			
125		23,4	25,0	26,6	28,0	29,4	30,7	31,9	33,1	34,3	35,4	36,5	37,6	38,6	39,6	40,6	41,5	42,5		125			
13		25,1	26,8	28,5	30,0	31,5	32,9	34,2	35,5	36,7	37,9	39,1	40,2	41,4	42,4	43,5	44,5	45,5		13			
14		26,8	28,6	30,4	32,0	33,6	35,1	36,5	37,9	39,2	40,5	41,7	42,9	44,1	45,3	46,4	47,5	48,5		14			
15		28,4	30,4	32,3	34,0	35,7	37,2	38,8	40,2	41,6	43,0	44,3	45,6	46,9	48,1	49,3	50,4	51,6		15			
16		30,1	32,2	34,2	36,0	37,8	39,4	41,0	42,6	44,1	45,5	46,9	48,3	49,6	50,9	52,2	53,4	54,6		16			
18		34,3	36,7	38,9	41,0	43,0	44,9	46,7	48,5	50,2	51,9	53,5	55,0	56,5	58,0	59,4	60,8	62,2		18			
19		36,0	38,5	40,8	43,0	45,1	47,1	49,0	50,9	52,7	54,4	56,1	57,7	59,3	60,8	62,3	63,8	65,2		19			
20		38,5	41,1	43,6	46,0	48,2	50,4	52,4	54,4	56,3	58,2	60,0	61,7	63,4	65,1	66,7	68,2	69,8		20			
25		47,7	51,0	54,1	57,0	59,8	62,4	65,0	67,4	69,8	72,1	74,3	76,5	78,6	80,6	82,6	84,5	86,4		25			
30		56,9	60,8	64,5	68,0	71,3	74,5	77,5	80,5	83,3	86,0	88,7	91,2	93,7	96,2	98,5	100,9	103,1		30			
35		66,9	71,6	75,9	80,0	83,9	87,6	91,2	94,7	98,0	101,2	104,3	107,3	110,3	113,1	115,9	118,7	121,3		35			
40		76,1	81,4	86,3	91,0	95,4	99,7	103,8	107,7	111,5	115,1	118,6	122,1	125,4	128,7	131,9	135,0	138,0		40			
50		95,4	102,0	108,1	114,0	119,6	124,9	130,0	134,9	139,6	144,2	148,6	152,9	157,1	161,2	165,2	169,1	172,9		50			
60		114,6	122,5	130,0	137,0	143,7	150,1	156,2	162,1	167,8	173,3	178,6	183,8	188,8	193,7	198,5	203,2	207,8		60			
70		133,9	143,1	151,8	160,0	167,8	175,3	182,4	189,3	196,0	202,4	208,6	214,7	220,5	226,3	231,9	237,3	242,7		70			
80		152,3	162,8	172,7	182,0	190,9	199,4	207,5	215,3	222,9	230,2	237,3	244,2	250,9	257,4	263,7	269,9	276,0		80			
90		171,5	183,0	194,5	205,0	215,0	224,6	233,7	242,6	251,1	259,3	267,3	275,0	282,6	289,9	297,1	304,1	310,9		90			
	bar MPa PSI	70 8 1015	80 9 1160	90 10 1305	100 11 1450	110 12 1595	120 13 1740	130 14 1885	140 15 2030	150 16 2175	160 17 2320	170 18 2465	180 19 2610	190 20 2755	200 21 2900	210 22 3045	220 23 3190	230 24 3335	bar MPa PSI				

* F.P. UGELLI SPECIALI

* F.P. UGELLI SPECIALI

Tutti gli ugelli PA sono forniti con tolleranze di ±5% sui dati riportati nella tabella
All PA nozzles are supplied with a ±5% tolerance on data reported in this table

Tutti gli ugelli PA sono forniti con tolleranze di ±5% sui dati riportati nella tabella
All PA nozzles are supplied with a ±5% tolerance on data reported in this table

* F.P. UGELLI SPECIALI

Tutti gli ugelli PA sono forniti con tolleranze di ±5% sui dati riportati nella tabella
All PA nozzles are supplied with a ±5% tolerance on data reported in this table

Fattore di Portata		Portata (l/min) alla Pressione (bar)																		Fattore di Portata	
Capacity Size		Flow rate (GPM) at Pressure (PSI)																		Capacity Size	
	bar MPa PSI	240 24 3480	250 25 3625	260 26 3770	270 27 3915	280 28 4060	290 29 4205	300 30 4350	310 31 4495	320 32 4640	330 33 4785	340 34 4930	350 35 5075	360 36 5220	370 37 5365	380 38 5510	390 39 5655	400 40 5800	410 41 5945	bar MPa PSI	
01		3,6	3,6	3,7	3,8	3,8	3,9	4,0	4,0	4,1	4,2	4,2	4,3	4,4	4,4	4,5	4,5	4,6	4,7		01
015		0,9	1,0	1,0	1,0	1,0	1,0	1,1	1,1	1,1	1,1	1,1	1,2	1,2	1,2	1,2	1,2	1,2	1,2		015
02		5,3	5,4	5,5	5,6	5,7	5,8	5,9	6,0	6,1	6,2	6,3	6,4	6,5	6,5	6,6	6,7	6,8	6,9		02
023*		1,4	1,4	1,4	1,5	1,5	1,5	1,6	1,6	1,6	1,6	1,7	1,7	1,7	1,7	1,8	1,8	1,8	1,8		023*
025*		7,1	7,3	7,4	7,6	7,7	7,8	8,0	8,1	8,2	8,4	8,5	8,6	8,7	8,8	9,0	9,1	9,2	9,3		025*
027*		1,9	1,9	2,0	2,0	2,0	2,1	2,1	2,1	2,2	2,2	2,2	2,3	2,3	2,3	2,4	2,4	2,4	2,5		027*
O23*		7,7	7,9	8,1	8,2	8,4	8,5	8,7	8,8	8,9	9,1	9,2	9,4	9,5	9,6	9,7	9,9	10,0	10,1		O23*
O25*		2,0	2,1	2,1	2,2	2,2	2,2	2,3	2,3	2,4	2,4	2,4	2,5	2,5	2,5	2,6	2,6	2,6	2,7		O25*
O27*		8,7	8,9	9,0	9,2	9,4	9,5	9,7	9,9	10,0	10,2	10,3	10,5	10,6	10,8	10,9	11,1	11,2	11,3		O27*
O25*		2,3	2,3	2,4	2,4	2,5	2,5	2,6	2,6	2,6	2,7	2,7	2,8	2,8	2,8	2,9	2,9	3,0	3,0		O25*
O27*		9,5	9,6	9,8	10,0	10,2	10,4	10,6	10,7	10,9	11,1	11,2	11,4	11,6	11,7	11,9	12,0	12,2	12,4		O27*
O27*		2,5	2,5	2,6	2,6	2,7	2,7	2,8	2,8	2,9	2,9	3,0	3,1	3,1	3,1	3,1	3,2	3,2	3,3		O27*
O3		10,5	10,8	11,0	11,2	11,4	11,6	11,8	12,0	12,2	12,4	12,5	12,7	12,9	13,1	13,3	13,4	13,6	13,8		O3
O32*		2,8	2,8	2,9	3,0	3,0	3,1	3,1	3,2	3,2	3,3	3,3	3,4	3,4	3,5	3,5	3,5	3,6	3,6		O32*
O32*		11,0	11,2	11,4	11,7	11,9	12,1	12,3	12,5	12,7	12,9	13,1	13,3	13,5	13,7	13,8	14,0	14,2	14,4		O32*
O32*		2,9	3,0	3,0	3,1	3,1	3,2	3,2	3,3	3,4	3,4	3,5	3,5	3,6	3,6	3,7	3,7	3,8	3,8		O32*
O35*		12,4	12,6	12,9	13,1	13,4	13,6	13,9	14,1	14,3	14,5	14,8	15,0	15,2	15,4	15,6	15,8	16,0	16,2		O35*
O35*		3,3	3,3	3,4	3,5	3,5	3,6	3,7	3,7	3,8	3,8	3,9	4,0	4,0	4,1	4,1	4,2	4,2	4,3		O35*
O37*		13,0	13,3	13,5	13,8	14,1	14,3	14,5	14,8	15,0	15,3	15,5	15,7	15,9	16,2	16,4	16,6	16,8	17,0		O37*
O37*		3,4	3,5	3,6	3,6	3,7	3,8	3,8	3,9	4,0	4,0	4,1	4,2	4,2	4,3	4,3	4,4	4,4	4,5		O37*
O4		14,1	14,4	14,7	15,0	15,2	15,5	15,8	16,0	16,3	16,5	16,8	17,0	17,3	17,5	17,7	18,0	18,2	18,4		O4
O43*		3,7	3,8	3,9	4,0	4,0	4,1	4,2	4,2	4,3	4,4	4,4	4,5	4,6	4,6	4,7	4,7	4,8	4,9		O43*
O43*		15,0	15,3	15,6	15,9	16,2	16,5	16,8	17,1	17,4	17,6	17,9	18,1	18,4	18,7	18,9	19,2	19,4	19,6		O43*
O43*		4,0	4,1	4,1	4,2	4,3	4,4	4,4	4,5	4,6	4,7	4,7	4,8	4,9	4,9	5,0	5,1	5,1	5,2		O43*
O45		16,0	16,3	16,6	16,9	17,2	17,5	17,8	18,1	18,4	18,7	19,0	19,3	19,5	19,8	20,1	20,3	20,6	20,9		O45
O45		4,2	4,3	4,4	4,5	4,6	4,6	4,7	4,8	4,9	4,9	5,0	5,1	5,2	5,2	5,3	5,4	5,4	5,5		O45
O5		17,7	18,0	18,4	18,7	19,1	19,4	19,7	20,1	20,4	20,7	21,0	21,3	21,6	21,9	22,2	22,5	22,8	23,1		O5
O53*		4,7	4,8	4,9	4,9	5,0	5,1	5,2	5,3	5,4	5,5	5,6	5,6	5,7	5,8	5,9	6,0	6,1	6,1		O53*
O53*		18,6	19,0	19,3	19,7	20,1	20,4	20,8	21,1	21,5	21,8	22,1	22,4	22,8	23,1	23,4	23,7	24,0	24,3		O53*
O53*		4,9	5,0	5,1	5,2	5,3	5,4	5,5	5,6	5,7	5,8	5,8	5,9	6,0	6,1	6,2	6,3	6,4	6,4		O53*
O55		19,4	19,8	20,2	20,5	20,9	21,3	21,7	22,0	22,4	22,7	23,0	23,4	23,7	24,0	24,4	24,7	25,0	25,3		O55
O55		5,1	5,2	5,3	5,4	5,5	5,6	5,7	5,8	5,9	6,0	6,1	6,2	6,3	6,4	6,4	6,5	6,6	6,7		O55
O6		21,2	21,7	22,1	22,5	22,9	23,3	23,7	24,1	24,5	24,9	25,3	25,6	26,0	26,4	26,7	27,1	27,4	27,7		O6
O6		5,6	5,7	5,8	5,9	6,1	6,2	6,3	6,4	6,5	6,6	6,7	6,8	6,9	7,0	7,1	7,1	7,2	7,3		O6
O65		22,9	23,4	23,9	24,3	24,8	25,2	25,6	26,1	26,5	26,9	27,3	27,7	28,1	28,5	28,9	29,2	29,6	30,0		O65
O65		6,1	6,2	6,3	6,4	6,5	6,7	6,8	6,9	7,0	7,1	7,2	7,3	7,4	7,5	7,6	7,7	7,8	7,9		O65
O7		24,8	25,3	25,8	26,3	26,8	27,2	27,7	28,2	28,6	29,1	29,5	29,9	30,4	30,8	31,2	31,6	32,0	32,4		O7
O7		6,5	6,7	6,8	6,9	7,1	7,2	7,3	7,4	7,6	7,7	7,8	7,9	8,0	8,1	8,2	8,3	8,5	8,6		O7
O75		26,5	27,0	27,6	28,1	28,6	29,1	29,6	30,1	30,6	31,1	31,5	32,0	32,4	32,9	33,3	33,8	34,2	34,6		O75
O75		7,0	7,1	7,3	7,4	7,6	7,7	7,8	8,0	8,1	8,2	8,3	8,5	8,6	8,7	8,8	8,9	9,0	9,1		O75
O8		28,2	28,8	29,3	29,9	30,5	31,0	31,5	32,0	32,6	33,1	33,6	34,0	34,5	35,0	35,5	35,9	36,4	36,9		O8
O8		7,4	7,6	7,8	7,9	8,0	8,2	8,3	8,5	8,6	8,7	8,9	9,0	9,1	9,2	9,4	9,5	9,6	9,7		O8
O85		30,1	30,7	31,3	31,9	32,5	33,0	33,6	34,2	34,7	35,2	35,8	36,3	36,8	37,3	37,8	38,3	38,8	39,3		O85
O85		7,9	8,1	8,3	8,4	8,6	8,7	8,9	9,0	9,2	9,3	9,5	9,6	9,7	9,9	10,0	10,1	10,3	10,4		O85
O9		32,5	33,2	33,9	34,5	35,1	35,8	36,4	37,0	37,6	38,1	38,7	39,3	39,8	40,4	40,9	41,5	42,0	42,5		O9
O9		8,6	8,8	8,9	9,1	9,3	9,4	9,6	9,8	9,9	10,1	10,2	10,4	10,5	10,7	10,8	11,0	11,1	11,2		O9
O95		34,1	34,8	35,5	36,1	36,8	37,5	38,1	38,7	39,4	40,0	40,6	41,2	41,7	42,3	42,9	43,4	44,0	44,5		O95
O95		9,0	9,2	9,4	9,6	9,7	9,9	10,1	10,2	10,4	10,6	10,7	10,9	11,0	11,2	11,3	11,5	11,6	11,8		O95
10		35,6	36,4	37,1	37,8	38,5	39,2	39,8	40,5	41,1	41,8	42,4	43,0	43,6	44,2	44,8	45,4	46,0	46,6		10
10		9,4	9,6	9,8	10,0	10,2	10,3	10,5	10,7	10,9	11,0	11,2	11,4	11,5	11,7	11,8	12,0	12,2	12,3		10
11		38,7	39,5	40,3	41,1	41,8	42,6	43,3	44,0	44,7	45,4	46,1	46,8	47,4	48,1	48,7	49,4	50,0	50,6		11
11		10,2	10,4	10,7	10,9	11,1	11,2	11,4	11,6	11,8	12,0	12,2	12,4	12,5	12,7	12,9	13,0	13,2	13,4		11
115		40,3	41,1	41,9	42,7	43,5	44,3	45,0	45,8	46,5	47,2	47,9	48,6	49,3	50,0	50,7	51,3	52,0	52,6		115
115		10,6	10,9	11,1	11,3	11,5	11,7	11,9	12,1	12,3	12,5	12,7	12,9	13,0	13,2	13,4	13,6	13,7	13,9		115
12		41,8	42,7	43,5	44,4	45,2	46,0	46,8	47,5	48,3	49,0	49,8	50,5	51,2	51,9	52,6	53,3	54,0	54,7		12
12		11,1	11,3	11,5	11,7	11,9	12,1	12,4	12,6	12,8	13,0	13,2	13,3	13,5	13,7	13,9	14,1	14,3	14,4		12
125		43,4	44,3	45,1	46,0	46,9	47,7	48,5	49,3	50,1	50,9	51,6	52,4	53,1	53,9	54,6	55,3	56,0	56,7		125
125		11,5	11,7	11,9	12,2	12,4	12,6	12,8	13,0	13,2	13,4	13,6	13,8	14,0	14,2	14,4	14,6	14,8	15,0		125
13		46,5	47,4	48,4	49,3	50,2	51,1	52,0	52,8	53,7	54,5	55,3	56,1	56,9	57,7	58,5	59,2	60,0	60,7		13
13		12,3	12,5	12,8	13,0	13,3	13,5	13,7	14,0	14,2	14,4	14,6	14,8	15,0	15,2	15,5	15,7	15,9	16,0		13
14		49,6	50,6	51,6	52,6	53,5	54,5	55,4	56,3	57,2	58,1	59,0	59,9	60,7	61,6	62,4	63,2	64,0	64,8		14
14		13,1	13,4	13,6	13,9	14,1	14,4	14,6	14,9	15,1	15,4	15,6	15,8	16,0	16,3	16,5	16,7	16,9	17,1		14
15		52,7	53,8	54,8	55,9	56,9	57,9	58,9	59,9	60,8	61,8	62,7	63,6	64,5	65,4	66,3	67,1	68,0	68,8		15
15		13,9	14,2	14,5	14,8	15,0	15,3	15,6	15,8	16,1	16,3	16,6	16,8	17,0	17,3	17,5	17,7	18,0	18,2		15
16		55,8	56,9																		

Fattore di Portata		Portata (l/min) alla Pressione (bar)																		Fattore di Portata					
Capacity Size		Flow rate (GPM) at Pressure (PSI)																		Capacity Size					
		bar	420	430	440	450	460	470	480	490	500	510	520	530	540	550	560	570	580	590	600	bar			
		MPa	42	43	44	45	46	47	48	49	50	51	52	53	54	55	56	57	58	59	60	MPa			
		PSI	6090	6235	6380	6525	6670	6815	6960	7105	7250	7395	7540	7685	7830	7975	8120	8265	8410	8555	8700	PSI			
* F.P. UGELLI SPECIALI	01		4,7	4,8	4,8	4,9	4,9	5,0	5,0	5,1	5,1	5,2	5,2	5,3	5,3	5,4	5,4	5,5	5,5	5,6	5,6		01		
			1,2	1,3	1,3	1,3	1,3	1,3	1,3	1,3	1,4	1,4	1,4	1,4	1,4	1,4	1,4	1,5	1,5	1,5	1,5	1,5			
		015	7,0	7,1	7,1	7,2	7,3	7,4	7,4	7,5	7,6	7,7	7,8	7,8	7,9	8,0	8,0	8,1	8,2	8,3	8,3	8,3		015	
			1,8	1,9	1,9	1,9	1,9	1,9	2,0	2,0	2,0	2,0	2,0	2,1	2,1	2,1	2,1	2,1	2,2	2,2	2,2	2,2			
		02	9,4	9,5	9,6	9,8	9,9	10,0	10,1	10,2	10,3	10,4	10,5	10,6	10,7	10,8	10,9	11,0	11,1	11,2	11,3	11,3		02	
			2,5	2,5	2,5	2,6	2,6	2,6	2,7	2,7	2,7	2,7	2,8	2,8	2,8	2,9	2,9	2,9	2,9	3,0	3,0	3,0			
		023*	10,2	10,4	10,5	10,6	10,7	10,8	11,0	11,1	11,2	11,3	11,4	11,5	11,6	11,7	11,8	11,9	12,0	12,1	12,2	12,2		023*	
			2,7	2,7	2,8	2,8	2,8	2,9	2,9	2,9	3,0	3,0	3,0	3,0	3,1	3,1	3,1	3,2	3,2	3,2	3,2	3,2			
		025*	11,5	11,6	11,7	11,9	12,0	12,1	12,3	12,4	12,5	12,6	12,8	12,9	13,0	13,1	13,3	13,4	13,5	13,6	13,7	13,7		025*	
			3,0	3,1	3,1	3,1	3,2	3,2	3,2	3,3	3,3	3,3	3,4	3,4	3,4	3,5	3,5	3,5	3,6	3,6	3,6	3,6			
		027*	12,5	12,6	12,8	12,9	13,1	13,2	13,4	13,5	13,6	13,8	13,9	14,0	14,2	14,3	14,4	14,6	14,7	14,8	14,9	14,9		027*	
			3,3	3,3	3,4	3,4	3,5	3,5	3,5	3,6	3,6	3,6	3,7	3,7	3,7	3,8	3,8	3,8	3,9	3,9	3,9	3,9			
		03	13,9	14,1	14,3	14,4	14,6	14,7	14,9	15,1	15,2	15,4	15,5	15,7	15,8	15,9	16,1	16,2	16,4	16,5	16,7	16,7		03	
			3,7	3,7	3,8	3,8	3,9	3,9	3,9	4,0	4,0	4,1	4,1	4,1	4,2	4,2	4,3	4,3	4,3	4,4	4,4	4,4			
		032*	14,6	14,7	14,9	15,1	15,2	15,4	15,6	15,7	15,9	16,0	16,2	16,3	16,5	16,7	16,8	17,0	17,1	17,2	17,4	17,4		032*	
		3,8	3,9	3,9	4,0	4,0	4,1	4,1	4,2	4,2	4,2	4,3	4,3	4,4	4,4	4,4	4,5	4,5	4,6	4,6	4,6				
	035*	16,4	16,6	16,8	17,0	17,2	17,3	17,5	17,7	17,9	18,1	18,2	18,4	18,6	18,8	18,9	19,1	19,3	19,4	19,6	19,6		035*		
		4,3	4,4	4,4	4,5	4,5	4,6	4,6	4,7	4,7	4,8	4,8	4,9	4,9	5,0	5,0	5,1	5,1	5,2	5,2	5,2				
	037*	17,2	17,4	17,6	17,8	18,0	18,2	18,4	18,6	18,8	19,0	19,2	19,3	19,5	19,7	19,9	20,1	20,2	20,4	20,6	20,6		037*		
		4,5	4,6	4,7	4,7	4,8	4,8	4,9	4,9	5,0	5,0	5,1	5,1	5,2	5,2	5,3	5,3	5,4	5,4	5,4	5,4				
	04	18,6	18,9	19,1	19,3	19,5	19,7	19,9	20,1	20,3	20,6	20,8	20,9	21,1	21,3	21,5	21,7	21,9	22,1	22,3	22,3		04		
		4,9	5,0	5,0	5,1	5,2	5,2	5,3	5,3	5,4	5,4	5,5	5,5	5,6	5,6	5,7	5,7	5,8	5,8	5,9	5,9				
	043*	19,9	20,1	20,3	20,6	20,8	21,0	21,3	21,5	21,7	21,9	22,1	22,3	22,5	22,7	23,0	23,2	23,4	23,6	23,8	23,8		043*		
		5,3	5,3	5,4	5,4	5,5	5,6	5,6	5,7	5,7	5,8	5,8	5,9	6,0	6,0	6,1	6,1	6,2	6,2	6,3	6,3				
	045	21,1	21,4	21,6	21,8	22,1	22,3	22,6	22,8	23,0	23,3	23,5	23,7	23,9	24,2	24,4	24,6	24,8	25,0	25,2	25,2		045		
		5,6	5,6	5,7	5,8	5,8	5,9	6,0	6,0	6,1	6,1	6,2	6,3	6,3	6,4	6,4	6,5	6,6	6,6	6,7	6,7				
	05	23,4	23,6	23,9	24,2	24,5	24,7	25,0	25,2	25,5	25,7	26,0	26,2	26,5	26,7	27,0	27,2	27,5	27,7	27,9	27,9		05		
		6,2	6,2	6,3	6,4	6,5	6,5	6,6	6,7	6,7	6,8	6,9	6,9	7,0	7,1	7,1	7,2	7,3	7,3	7,4	7,4				
	053*	24,6	24,9	25,2	25,5	25,7	26,0	26,3	26,6	26,8	27,1	27,4	27,6	27,9	28,1	28,4	28,6	28,9	29,1	29,4	29,4		053*		
		6,5	6,6	6,7	6,7	6,8	6,9	6,9	7,0	7,1	7,2	7,2	7,3	7,4	7,4	7,5	7,6	7,6	7,7	7,8	7,8				
	055	25,6	25,9	26,2	26,5	26,8	27,1	27,4	27,7	28,0	28,2	28,5	28,8	29,0	29,3	29,6	29,8	30,1	30,4	30,6	30,6		055		
		6,8	6,8	6,9	7,0	7,1	7,2	7,2	7,3	7,4	7,5	7,5	7,6	7,7	7,7	7,8	7,9	8,0	8,1	8,1	8,1				
	06	28,1	28,4	28,7	29,1	29,4	29,7	30,0	30,3	30,6	30,9	31,2	31,5	31,8	32,1	32,4	32,7	33,0	33,3	33,6	33,6		06		
		7,4	7,5	7,6	7,7	7,8	7,8	7,9	8,0	8,1	8,2	8,3	8,3	8,4	8,5	8,6	8,6	8,7	8,8	8,9	8,9				
	065	30,3	30,7	31,0	31,4	31,7	32,1	32,4	32,8	33,1	33,4	33,7	34,1	34,4	34,7	35,0	35,3	35,6	35,9	36,3	36,3		065		
		8,0	8,1	8,2	8,3	8,4	8,5	8,6	8,7	8,7	8,8	8,9	9,0	9,1	9,2	9,3	9,4	9,5	9,6	9,6	9,6				
	07	32,8	33,2	33,6	33,9	34,3	34,7	35,1	35,4	35,8	36,1	36,5	36,8	37,2	37,5	37,9	38,2	38,5	38,9	39,2	39,2		07		
		8,7	8,8	8,9	9,0	9,1	9,2	9,3	9,4	9,5	9,5	9,6	9,7	9,8	9,9	10,0	10,1	10,2	10,3	10,4	10,4				
	075	35,0	35,5	35,9	36,3	36,7	37,1	37,5	37,9	38,2	38,6	39,0	39,4	39,7	40,1	40,5	40,8	41,2	41,5	41,9	41,9		075		
		9,3	9,4	9,5	9,6	9,7	9,8	9,9	10,0	10,1	10,2	10,3	10,4	10,5	10,6	10,7	10,8	10,9	11,0	11,1	11,1				
	08	37,3	37,7	38,2	38,6	39,0	39,5	39,9	40,3	40,7	41,1	41,5	41,9	42,3	42,7	43,1	43,5	43,8	44,2	44,6	44,6		08		
		9,9	10,0	10,1	10,2	10,3	10,4	10,5	10,6	10,8	10,9	11,0	11,1	11,2	11,3	11,4	11,5	11,6	11,7	11,8	11,8				
	085	39,8	40,2	40,7	41,2	41,6	42,1	42,5	42,9	43,4	43,8	44,2	44,7	45,1	45,5	45,9	46,3	46,7	47,1	47,5	47,5		085		
		10,5	10,6	10,8	10,9	11,0	11,1	11,2	11,3	11,5	11,6	11,7	11,8	11,9	12,0	12,1	12,2	12,3	12,4	12,6	12,6				
	09	43,0	43,5	44,0	44,5	45,0	45,5	46,0	46,5	47,0	47,4	47,9	48,3	48,8	49,2	49,7	50,1	50,6	51,0	51,4	51,4		09		
		11,4	11,5	11,6	11,8	11,9	12,0	12,2	12,3	12,4	12,5	12,7	12,8	12,9	13,0	13,1	13,2	13,4	13,5	13,6	13,6				
	095	45,1	45,6	46,1	46,7	47,2	47,7	48,2	48,7	49,2	49,7	50,2	50,6	51,1	51,6	52,1	52,5	53,0	53,4	53,9	53,9		095		
		11,9	12,1	12,2	12,3	12,5	12,6	12,7	12,9	13,0	13,1	13,3	13,4	13,5	13,6	13,8	13,9	14,0	14,1	14,2	14,2				
	10	47,1	47,7	48,2	48,8	49,3	49,9	50,4	50,9	51,4	51,9	52,4	52,9	53,4	53,9	54,4	54,9	55,4	55,9	56,3	56,3		10		
		12,5	12,6	12,7	12,9	13,0	13,2	13,3	13,5	13,6	13,7	13,9	14,0	14,1	14,3	14,4	14,5	14,6	14,8	14,9	14,9				
	11	51,2	51,8	52,4	53,0	53,6	54,2	54,8	55,3	55,9	56,5	57,0	57,6	58,1	58,6	59,2	59,7	60,2	60,7	61,2	61,2		11		
		13,5	13,7	13,9	14,0	14,2	14,3	14,5	14,6	14,8	14,9	15,1	15,2	15,3	15,5	15,6	15,8	15,9	16,0	16,2	16,2				
	115	53,3	53,9	54,5	55,2	55,8	56,4	57,0	57,6	58,1	58,7	59,3	59,9	60,4	61,0	61,5	62,1	62,6	63,2	63,7	63,7		115		
		14,1	14,2	14,4	14,6	14,7	14,9	15,0	15,2	15,4	15,5	15,7	15,8	16,0	16,1	16,3	16,4	16,5	16,7	16,8	16,8				
	12	55,3	56,0	56,6	57,3	57,9	58,5	59,2	59,8	60,4	61,0	61,6	62,2	62,7	63,3	63,9	64,5	65,0	65,6	66,1	66,1		12		
		14,6	14,8	15,0	15,1	15,3	15,5	15,6	15,8	16,0	16,1	16,3	16,4	16,6	16,7	16,9	17,0	17,2	17,3	17,5	17,5				

Fattore di Portata		Portata (l/min) alla Pressione (bar)																		Fattore di Portata		
Capacity Size		Flow rate (GPM) at Pressure (PSI)																		Capacity Size		
	bar MPa PSI	610 61 8845	620 62 8990	630 63 9135	640 64 9280	650 65 9425	660 66 9570	670 67 9715	680 68 9860	690 69 10005	700 70 10150	710 71 10295	720 72 10440	730 73 10585	740 74 10730	750 75 10875	760 76 11020	770 77 11165	780 78 11310	790 79 11455	bar MPa PSI	
01		5,7	5,7	5,8	5,8	5,9	5,9	6,0	6,0	6,1	6,1	6,2	6,2	6,3	6,3	6,3	6,4	6,4	6,5	6,5	01	
015		1,5	1,5	1,5	1,5	1,5	1,6	1,6	1,6	1,6	1,6	1,6	1,6	1,7	1,7	1,7	1,7	1,7	1,7	1,7	015	
02		8,4	8,5	8,5	8,6	8,7	8,7	8,8	8,9	8,9	9,0	9,1	9,1	9,2	9,2	9,3	9,4	9,4	9,5	9,6	02	
023*		2,2	2,2	2,3	2,3	2,3	2,3	2,3	2,3	2,4	2,4	2,4	2,4	2,4	2,5	2,5	2,5	2,5	2,5	2,5	023*	
025*		11,4	11,5	11,5	11,6	11,7	11,8	11,9	12,0	12,1	12,2	12,3	12,3	12,4	12,5	12,6	12,7	12,8	12,9	12,9	025*	
027*		3,0	3,0	3,1	3,1	3,1	3,1	3,1	3,2	3,2	3,2	3,2	3,3	3,3	3,3	3,4	3,4	3,4	3,4	3,4	027*	
O23*		12,3	12,4	12,5	12,6	12,7	12,8	12,9	13,0	13,1	13,2	13,3	13,4	13,5	13,6	13,7	13,8	13,9	14,0	14,1	O23*	
O25*		3,3	3,3	3,3	3,3	3,4	3,4	3,4	3,4	3,5	3,5	3,5	3,5	3,6	3,6	3,6	3,7	3,7	3,7	3,7	O25*	
O27*		13,8	13,9	14,1	14,2	14,3	14,4	14,5	14,6	14,7	14,8	14,9	15,0	15,1	15,2	15,3	15,4	15,5	15,6	15,7	O27*	
O3		3,7	3,7	3,7	3,7	3,8	3,8	3,8	3,9	3,9	3,9	3,9	4,0	4,0	4,0	4,1	4,1	4,1	4,1	4,2	O3	
O32*		15,1	15,2	15,3	15,4	15,6	15,7	15,8	15,9	16,0	16,1	16,3	16,4	16,5	16,6	16,7	16,8	16,9	17,0	17,1	O32*	
O35*		4,0	4,0	4,0	4,1	4,1	4,1	4,2	4,2	4,2	4,3	4,3	4,3	4,4	4,4	4,4	4,5	4,5	4,5	4,5	O35*	
O37*		16,8	16,9	17,1	17,2	17,3	17,5	17,6	17,7	17,9	18,0	18,1	18,2	18,4	18,5	18,6	18,7	18,9	19,0	19,1	O37*	
O4		4,4	4,5	4,5	4,5	4,6	4,6	4,7	4,7	4,7	4,8	4,8	4,8	4,9	4,9	4,9	5,0	5,0	5,0	5,0	O4	
O43*		17,5	17,7	17,8	18,0	18,1	18,2	18,4	18,5	18,7	18,8	18,9	19,1	19,2	19,3	19,4	19,6	19,7	19,8	20,0	O43*	
O45		4,6	4,7	4,7	4,7	4,8	4,8	4,9	4,9	4,9	5,0	5,0	5,0	5,1	5,1	5,1	5,2	5,2	5,3	5,3	O45	
O5		19,8	19,9	20,1	20,2	20,4	20,6	20,7	20,9	21,0	21,2	21,3	21,5	21,6	21,8	21,9	22,1	22,2	22,3	22,5	O5	
O53*		5,2	5,3	5,3	5,3	5,4	5,4	5,5	5,5	5,6	5,6	5,6	5,7	5,7	5,7	5,8	5,8	5,9	5,9	5,9	O53*	
O55		20,7	20,9	21,1	21,3	21,4	21,6	21,7	21,9	22,1	22,2	22,4	22,5	22,7	22,9	23,0	23,2	23,3	23,5	23,6	O55	
O6		5,5	5,5	5,6	5,6	5,7	5,7	5,7	5,8	5,8	5,9	5,9	6,0	6,0	6,0	6,1	6,1	6,2	6,2	6,2	O6	
O65		22,5	22,7	22,8	23,0	23,2	23,4	23,6	23,7	23,9	24,1	24,2	24,4	24,6	24,8	24,9	25,1	25,3	25,4	25,6	O65	
O7		5,9	6,0	6,0	6,1	6,1	6,2	6,2	6,3	6,3	6,4	6,4	6,5	6,5	6,5	6,6	6,6	6,7	6,7	6,8	O7	
O75		24,0	24,2	24,3	24,5	24,7	24,9	25,1	25,3	25,5	25,7	25,8	26,0	26,2	26,4	26,6	26,7	26,9	27,1	27,3	O75	
O8		6,3	6,4	6,4	6,5	6,5	6,6	6,6	6,7	6,7	6,8	6,8	6,9	6,9	7,0	7,0	7,1	7,1	7,2	7,2	O8	
O85		25,4	25,6	25,9	26,1	26,3	26,5	26,7	26,9	27,1	27,3	27,4	27,6	27,8	28,0	28,2	28,4	28,6	28,8	29,0	O85	
O9		6,7	6,8	6,8	6,9	6,9	7,0	7,0	7,1	7,1	7,2	7,3	7,3	7,4	7,4	7,5	7,5	7,6	7,6	7,6	O9	
O95		28,2	28,4	28,6	28,8	29,1	29,3	29,5	29,7	29,9	30,2	30,4	30,6	30,8	31,0	31,2	31,4	31,6	31,8	32,0	O95	
10		7,4	7,5	7,6	7,6	7,7	7,7	7,8	7,9	8,0	8,0	8,1	8,1	8,2	8,2	8,3	8,4	8,4	8,5	8,5	10	
11		29,6	29,9	30,1	30,4	30,6	30,8	31,1	31,3	31,5	31,7	32,0	32,2	32,4	32,6	32,9	33,1	33,3	33,5	33,7	11	
115		7,8	7,9	8,0	8,0	8,1	8,1	8,2	8,3	8,3	8,4	8,4	8,5	8,6	8,6	8,7	8,8	8,8	8,9	8,9	115	
12		30,9	31,1	31,4	31,6	31,9	32,1	32,4	32,6	32,8	33,1	33,3	33,5	33,8	34,0	34,2	34,5	34,7	34,9	35,1	12	
125		8,2	8,2	8,3	8,4	8,4	8,5	8,5	8,6	8,7	8,7	8,8	8,9	8,9	9,0	9,0	9,1	9,2	9,2	9,3	125	
13		33,8	34,1	34,4	34,7	34,9	35,2	35,5	35,7	36,0	36,2	36,5	36,8	37,0	37,3	37,5	37,8	38,0	38,3	38,5	13	
14		8,9	9,0	9,1	9,2	9,2	9,3	9,4	9,4	9,5	9,6	9,6	9,7	9,8	9,8	9,9	10,0	10,0	10,1	10,2	14	
15		36,6	36,9	37,1	37,4	37,7	38,0	38,3	38,6	38,9	39,2	39,4	39,7	40,0	40,3	40,5	40,8	41,1	41,3	41,6	15	
16		9,7	9,7	9,8	9,9	10,0	10,0	10,1	10,2	10,3	10,3	10,4	10,5	10,6	10,6	10,7	10,8	10,9	10,9	11,0	16	
18		39,5	39,8	40,2	40,5	40,8	41,1	41,4	41,7	42,0	42,3	42,6	42,9	43,2	43,5	43,8	44,1	44,4	44,7	45,0	18	
19		10,4	10,5	10,6	10,7	10,8	10,9	10,9	11,0	11,1	11,2	11,3	11,3	11,4	11,5	11,6	11,7	11,7	11,8	11,9	19	
20		42,2	42,6	42,9	43,3	43,6	43,9	44,3	44,6	44,9	45,2	45,6	45,9	46,2	46,5	46,8	47,1	47,5	47,8	48,1	20	
25		11,2	11,2	11,3	11,4	11,5	11,6	11,7	11,8	11,9	12,0	12,0	12,1	12,2	12,3	12,4	12,5	12,5	12,6	12,7	25	
30		45,0	45,3	45,7	46,0	46,4	46,8	47,1	47,5	47,8	48,2	48,5	48,8	49,2	49,5	49,8	50,2	50,5	50,8	51,2	30	
35		11,9	12,0	12,1	12,2	12,3	12,4	12,4	12,5	12,6	12,7	12,8	12,9	13,0	13,1	13,2	13,3	13,3	13,4	13,5	35	
40		47,9	48,3	48,7	49,1	49,5	49,8	50,2	50,6	51,0	51,3	51,7	52,1	52,4	52,8	53,1	53,5	53,8	54,2	54,5	40	
50		12,7	12,8	12,9	13,0	13,1	13,2	13,3	13,4	13,5	13,6	13,7	13,8	13,8	13,9	14,0	14,1	14,2	14,3	14,4	50	
60		51,9	52,3	52,7	53,1	53,5	53,9	54,4	54,8	55,2	55,6	56,0	56,3	56,7	57,1	57,5	57,9	58,3	58,6	59,0	60	
70		13,7	13,8	13,9	14,0	14,1	14,3	14,4	14,5	14,6	14,7	14,8	14,9	15,0	15,1	15,2	15,3	15,4	15,5	15,6	70	
80		54,3	54,8	55,2	55,7	56,1	56,5	56,9	57,4	57,8	58,2	58,6	59,0	59,4	59,8	60,2	60,6	61,0	61,4	61,8	80	
90		14,4	14,5	14,6	14,7	14,8	14,9	15,0	15,2	15,3	15,4	15,5	15,6	15,7	15,8	15,9	16,0	16,1	16,2	16,3	90	
10		56,8	57,3	57,7	58,2	58,6	59,1	59,5	60,0	60,4	60,9	61,3	61,7	62,1	62,6	63,0	63,4	63,8	64,2	64,6	10	
11		15,0	15,1	15,3	15,4	15,5	15,6	15,7	15,8	16,0	16,1	16,2	16,3	16,4	16,5	16,6	16,8	16,9	17,0	17,1	11	
115		61,7	62,2	62,7	63,2	63,7	64,2	64,7	65,2	65,7	66,1	66,6	67,1	67,5	68,0	68,5	68,9	69,4	69,8	70,3	115	
12		16,3	16,4	16,6	16,7	16,8	17,0	17,1	17,2	17,3	17,5	17,6	17,7	17,8	18,0	18,1	18,2	18,3	18,4	18,6	12	
125		64,2	64,7	65,3	65,8	66,3	66,8	67,3	67,8	68,3	68,8	69,3	69,8	70,2	70,7	71,2	71,7	72,1	72,6	73,1	125	
13		17,0	17,1	17,2	17,4	17,5	17,6	17,8	17,9	18,0	18,2	18,3	18,4	18,6	18,7	18,8	18,9	19,1	19,2	19,3	13	
14		66,7	67,2	67,8	68,3	68,8	69,4	69,9	70,4	70,9	71,4	71,9	72,4	72,9	73,4	73,9	74,4	74,9	75,4	75,9	14	
15		17,6	17,8	17,9	18,0	18,2	18,3	18,5	18,6	18,7	18,9	19,0	19,1	19,3	19,4	19,5	19,7	19,8	19,9	20,0	15	
16		69,2	69,7	70,3	70,8	71,4	71,9	72,5	73,0	73,5	74,1	74,6	75,1	75,7	76,2	76,7	77,2	77,7	78,2	78,7	16	
18		18,3	18,4	18,6	18,7	18,9	19,0	19,1	19,3	19,4	19,6	19,7	19,8	20,0	20,1	20,3	20,4	20,5	20,7	20,8	18	
19		74,1	74,7	75,3	75,9	76,5	77,1	77,7	78,2	78,8	79,4	79,9	80,5	81,1	81,6	82,2	82,7	83,2	83,8	84,3	19	
20		19,6	19,7	19,9	20,1	20,2	20,4	20,5	20,7	20,8	21,0	21,1	21,3	21,4	21,6	21,7	21,9	22,0	22,1	22,3	20	
25		79,0	79,7	80,3	81,0	81,6	82,2	82,8	83,4	84,1	84,7	85,3	85,9	86,5	87,0	87,6	88,2	88,8	89,4	89,9	25	
30		20,9	21,1	21,2	21,4	21,6	21,7	21,9	22,0	22,2	22,4	22,5	22,7	22,8	23,0	23,2	23,3	23,5	23,6	23,8	30	
35		84,0	84,7	85,3	86,0	86,7	87,3	88,0	88,7	89,												

Fattore di Portata		Portata (l/min) alla Pressione (bar)																		Fattore di Portata			
Capacity Size		Flow rate (GPM) at Pressure (PSI)																		Capacity Size			
	bar MPa PSI	800 80 11600	810 81 11745	820 82 11890	830 83 12035	840 84 12180	850 85 12325	860 86 12470	870 87 12615	880 88 12760	890 89 12905	900 90 13050	910 91 13195	920 92 13340	930 93 13485	940 94 13630	950 95 13775	960 96 13920	970 97 14065	980 98 14210	1000 100 14500	bar MPa PSI	
	01	6,5 1,7	6,5 1,7	6,6 1,7	6,6 1,8	6,7 1,8	6,7 1,8	6,7 1,8	6,8 1,8	6,8 1,8	6,9 1,8	6,9 1,8	6,9 1,8	7,0 1,8	7,0 1,9	7,1 1,9	7,1 1,9	7,1 1,9	7,2 1,9	7,2 1,9	7,3 1,9	01	
	015	9,6 2,5	9,7 2,6	9,7 2,6	9,8 2,6	9,9 2,6	9,9 2,6	10,0 2,6	10,0 2,6	10,1 2,7	10,1 2,7	10,2 2,7	10,3 2,7	10,3 2,7	10,4 2,7	10,4 2,8	10,5 2,8	10,5 2,8	10,6 2,8	10,6 2,8	10,8 2,8	015	
	O2	13,0 3,4	13,1 3,5	13,2 3,5	13,3 3,5	13,3 3,5	13,4 3,5	13,5 3,6	13,6 3,6	13,6 3,6	13,7 3,6	13,8 3,6	13,9 3,7	14,0 3,7	14,0 3,7	14,1 3,7	14,2 3,7	14,3 3,8	14,3 3,8	14,4 3,8	14,5 3,8	O2	
	O23*	14,1 3,7	14,2 3,8	14,3 3,8	14,4 3,8	14,5 3,8	14,6 3,9	14,7 3,9	14,7 3,9	14,8 3,9	14,9 3,9	15,0 4,0	15,1 4,0	15,2 4,0	15,2 4,0	15,3 4,1	15,4 4,1	15,5 4,1	15,6 4,1	15,7 4,1	15,8 4,2	O23*	
	O25*	15,8 4,2	15,9 4,2	16,0 4,2	16,1 4,3	16,2 4,3	16,3 4,3	16,4 4,3	16,5 4,4	16,6 4,4	16,7 4,4	16,8 4,4	16,9 4,5	17,0 4,5	17,1 4,5	17,2 4,5	17,3 4,6	17,4 4,6	17,4 4,6	17,5 4,6	17,7 4,7	O25*	
	O27*	17,3 4,6	17,4 4,6	17,5 4,6	17,6 4,6	17,7 4,7	17,8 4,7	17,9 4,7	18,0 4,8	18,1 4,8	18,2 4,8	18,3 4,8	18,4 4,9	18,5 4,9	18,6 4,9	18,7 4,9	18,8 5,0	18,9 5,0	19,0 5,0	19,1 5,0	19,3 5,1	O27*	
	O3	19,2 5,1	19,4 5,1	19,5 5,1	19,6 5,2	19,7 5,2	19,8 5,2	19,9 5,3	20,1 5,3	20,2 5,3	20,3 5,4	20,4 5,4	20,5 5,4	20,6 5,4	20,7 5,5	20,8 5,5	21,0 5,5	21,1 5,6	21,2 5,6	21,3 5,6	21,5 5,7	O3	
	O32*	20,1 5,3	20,2 5,3	20,3 5,4	20,5 5,4	20,6 5,4	20,7 5,5	20,8 5,5	20,9 5,5	21,1 5,6	21,2 5,6	21,3 5,6	21,4 5,7	21,5 5,7	21,7 5,7	21,8 5,8	21,9 5,8	22,0 5,8	22,1 5,8	22,2 5,8	22,5 5,9	O32*	
	O35*	22,6 6,0	22,8 6,0	22,9 6,1	23,0 6,1	23,2 6,1	23,3 6,2	23,5 6,2	23,6 6,2	23,7 6,3	23,9 6,3	24,0 6,3	24,1 6,4	24,3 6,4	24,4 6,4	24,5 6,5	24,7 6,5	24,8 6,5	24,8 6,6	25,0 6,6	25,3 6,7	O35*	
	O37*	23,8 6,3	23,9 6,3	24,1 6,4	24,2 6,4	24,3 6,4	24,5 6,5	24,6 6,5	24,8 6,5	24,9 6,6	25,1 6,6	25,2 6,7	25,3 6,7	25,5 6,7	25,6 6,8	25,8 6,8	25,9 6,8	26,0 6,9	26,2 6,9	26,3 6,9	26,6 7,0	O37*	
	O4	25,7 6,8	25,9 6,8	26,1 6,9	26,2 6,9	26,4 7,0	26,5 7,0	26,7 7,1	26,8 7,1	27,0 7,1	27,1 7,2	27,3 7,2	27,5 7,3	27,6 7,3	27,8 7,3	27,9 7,4	28,0 7,4	28,2 7,4	28,3 7,5	28,5 7,5	28,8 7,6	O4	
	O43*	27,4 7,2	27,6 7,3	27,8 7,3	27,9 7,4	28,1 7,4	28,3 7,5	28,4 7,5	28,6 7,6	28,8 7,6	28,9 7,6	29,1 7,7	29,3 7,7	29,4 7,8	29,6 7,8	29,7 7,9	29,9 7,9	30,1 7,9	30,2 8,0	30,4 8,0	30,7 8,1	O43*	
	O45	29,1 7,7	29,3 7,7	29,5 7,8	29,7 7,8	29,9 7,9	30,0 8,0	30,2 8,0	30,4 8,1	30,6 8,1	30,7 8,1	30,9 8,2	31,1 8,2	31,2 8,3	31,4 8,3	31,6 8,3	31,7 8,4	31,9 8,4	32,1 8,5	32,2 8,5	32,6 8,6	O45	
	O5	32,2 8,5	32,4 8,6	32,6 8,6	32,8 8,7	33,0 8,7	33,2 8,8	33,4 8,8	33,6 8,9	33,8 8,9	34,0 9,0	34,2 9,0	34,4 9,1	34,6 9,1	34,8 9,2	35,0 9,2	35,1 9,3	35,3 9,3	35,5 9,4	35,7 9,4	36,0 9,5	O5	
	O53*	33,9 9,0	34,2 9,0	34,4 9,1	34,6 9,1	34,8 9,2	35,0 9,2	35,2 9,3	35,4 9,4	35,6 9,4	35,8 9,5	36,0 9,5	36,2 9,6	36,4 9,6	36,6 9,7	36,8 9,7	37,0 9,8	37,2 9,8	37,4 9,9	37,6 9,9	37,9 10,0	O53*	
	O55	35,4 9,3	35,6 9,4	35,8 9,5	36,0 9,5	36,2 9,6	36,4 9,6	36,7 9,7	36,9 9,7	37,1 9,8	37,3 9,8	37,5 9,9	37,7 10,0	37,9 10,0	38,1 10,1	38,3 10,1	38,5 10,2	38,7 10,2	38,9 10,3	39,1 10,3	39,5 10,4	O55	
	O6	38,7 10,2	39,0 10,3	39,2 10,4	39,5 10,4	39,7 10,5	39,9 10,6	40,2 10,6	40,4 10,7	40,6 10,7	40,9 10,8	41,1 10,9	41,3 10,9	41,6 11,0	41,8 11,0	42,0 11,1	42,2 11,2	42,4 11,2	42,7 11,3	42,9 11,3	43,3 11,4	O6	
	O65	41,9 11,1	42,1 11,1	42,4 11,2	42,6 11,3	42,9 11,3	43,1 11,4	43,4 11,5	43,7 11,5	43,9 11,6	44,2 11,7	44,4 11,7	44,6 11,8	44,9 11,9	45,1 12,0	45,4 12,1	45,6 12,1	45,9 12,2	46,1 12,2	46,3 12,2	46,8 12,4	O65	
	O7	45,3 12,0	45,5 12,0	45,8 12,1	46,1 12,2	46,4 12,3	46,6 12,3	46,9 12,4	47,2 12,5	47,5 12,5	47,7 12,6	48,0 12,7	48,3 12,8	48,5 12,8	48,8 12,9	49,1 13,0	49,3 13,0	49,6 13,1	49,8 13,2	50,1 13,2	50,6 13,4	O7	
	O75	48,4 12,8	48,7 12,9	49,0 12,9	49,3 13,0	49,6 13,1	49,9 13,2	50,1 13,2	50,4 13,3	50,7 13,4	51,0 13,5	51,3 13,6	51,6 13,6	51,9 13,7	52,1 13,8	52,4 13,9	52,7 13,9	53,0 14,0	53,3 14,1	53,5 14,1	54,1 14,3	O75	
	O8	51,5 13,6	51,8 13,7	52,1 13,8	52,4 13,9	52,7 13,9	53,1 14,0	53,4 14,1	53,7 14,2	54,0 14,3	54,3 14,3	54,6 14,4	54,9 14,5	55,2 14,6	55,5 14,7	55,8 14,7	56,1 14,8	56,4 14,9	56,7 15,0	57,0 15,1	57,6 15,2	O8	
	O85	54,9 14,5	55,2 14,6	55,6 14,7	55,9 14,8	56,2 14,9	56,6 14,9	56,9 15,0	57,2 15,1	57,5 15,2	57,9 15,3	58,2 15,4	58,5 15,5	58,8 15,5	59,2 15,6	59,5 15,7	59,8 15,8	60,1 15,9	60,4 16,0	60,7 16,0	61,3 16,2	O85	
	O9	59,4 15,7	59,8 15,8	60,1 15,9	60,5 16,0	60,9 16,1	61,2 16,2	61,6 16,3	61,9 16,4	62,3 16,5	62,6 16,6	63,0 16,6	63,3 16,7	63,7 16,8	64,0 16,9	64,4 17,0	64,7 17,1	65,1 17,2	65,4 17,3	65,7 17,4	66,4 17,5	O9	
	O95	62,2 16,4	62,6 16,5	63,0 16,6	63,4 16,7	63,8 16,8	64,1 16,9	64,5 17,0	64,9 17,1	65,3 17,2	65,6 17,3	66,0 17,4	66,4 17,5	66,7 17,6	67,1 17,7	67,5 17,8	67,8 17,9	68,2 18,0	68,5 18,1	68,9 18,2	69,6 18,4	O95	
	10	65,1 17,2	65,5 17,3	65,9 17,4	66,3 17,5	66,7 17,6	67,1 17,7	67,4 17,8	67,8 17,9	68,2 18,0	68,6 18,1	69,0 18,2	69,4 18,3	69,8 18,4	70,1 18,5	70,5 18,6	70,9 18,7	71,3 18,8	71,6 18,9	72,0 19,0	72,7 19,2	10	
	11	70,7 18,7	71,2 18,8	71,6 18,9	72,0 19,0	72,5 19,1	72,9 19,3	73,3 19,4	73,7 19,5	74,2 19,6	74,6 19,7	75,0 19,8	75,4 19,9	75,8 20,0	76,2 20,1	76,6 20,2	77,1 20,3	77,5 20,4	77,9 20,5	78,3 20,7	79,1 20,9	11	
	115	73,5 19,4	74,0 19,6	74,5 19,7	74,9 19,8	75,4 19,9	75,8 20,0	76,2 20,1	76,7 20,3	77,1 20,4	77,6 20,5	78,0 20,6	78,4 20,7	78,9 20,8	79,3 20,9	79,7 21,1	80,1 21,2	80,6 21,3	81,0 21,4	81,4 21,5	82,2 21,7	115	
	12	76,4 20,2	76,8 20,3	77,3 20,4	77,8 20,6	78,3 20,7	78,7 20,8	79,2 20,9	79,6 21,0	80,1 21,2	80,5 21,3	81,0 21,4	81,4 21,5	81,9 21,6	82,3 21,8	82,8 21,9	83,2 22,0	83,7 22,1	84,1 22,2	84,5 22,3	85,4 22,6	12	
	125	79,2 20,9	79,7 21,1	80,2 21,2	80,7 21,3	81,2 21,4	81,6 21,6	82,1 21,7	82,6 21,8	83,1 21,9	83,5 22,1	84,0 22,2	84,5 22,3	84,9 22,4	85,4 22,6	85,8 22,7	86,3 22,8	86,8 22,9	87,2 23,0	87,7 23,2	88,5 23,4	125	
	13	84,9 22,4	85,4 22,6	85,9 22,7	86,4 22,8	86,9 23,0	87,5 23,1	88,0 23,2	88,5 23,4	89,0 23,5	89,5 23,6	90,0 23,8	90,5 23,9	91,0 24,0	91,5 24,2	92,0 24,3	92,5 24,4	93,0 24,6	93,4 24,7	93,9 24,8	94,9 25,1	13	
	14	90,5 23,9	91,1 24,1	91,6 24,2	92,2 24,4	92,7 24,5	93,3 24,6	93,8 24,8	94,4 24,9	94,9 25,1	95,5 25,2	96,0 25,4	96,5 25,5	97,1 25,6	97,6 25,8	98,1 25,9	98,6 26,1	99,1 26,2	99,7 26,3	100,2 26,5	101,2 26,7	14	
	15	96,2 25,4	96,8 25,6	97,4 25,7	98,0 25,9	98,5 26,0	99,1 26,2	99,7 26,3	100,3 26,5	100,9 26,6	101,4 26,8	102,0 26,9	102,6 27,1	103,1 27,2	103,7 27,4	104,2 27,5	104,8 27,7	105,3 27,8	105,9 28,0	106,4 28,1	107,5 28,4	15	
	16	101,8 26,9	102,5 27,1	103,1 27,2	103,7 27,4	104,3 27,6	105,0 27,7	105,6 27,9	106,2 28,1	106,8 28,2	107,4 28,4	108,0 28,5	108,6 28,7	109,2 28,8	109,8 29,0	110,4 29,2	111,0 29,3	111,5 29,5	112,1 29,6	112,7 29,8	113,8 30,1	16	
	18	116,0 30,6	116,7 30,8	117,4 31,0	118,1 31,2	118,8 31,4	119,5 31,6	120,2 31,8	120,9 32,0	121,6 32,1	122,3 32,3	123,0 32,5	123,7 32,7	124,4 32,9	125,0 33,0	125,7 33,2	126,4 33,4	127,0 33,6	127,7 33,7	128,4 33,9	129,7 34,3	18	
	19	121,6 32,1	122,4 32,3	123,1 32,5	123,9 32,7	124,6 32,9	125,4 33,1	126,2 33,3	126,8 33,5	127,6 33,7	128,3 33,9	129,0 34,1	129,7 34,3	130,4 34,5	131,1 34,6	131,8 34,8	132,5 35,0	133,2 35,2	133,9 35,4	134,6 35,6	136,0 35,9	19	
	20	130,1 34,4	130,9 34,6	131,7 34,8	132,5 35,0	133,3 35,2	134,1 35,4	134,9 35,6	135,7 35,8	136,5 36,1	137,2 36,3	138,0 36,5	138,8 36,7	139,5 36,9	140,3 37,1	141,0 37,3	141,8 37,5	142,5 37,7	143,3 37,9	144,0 38,0	145,5 38,4	20	
	25	161,2 42,6	162,2 42,9	163,2 43,1																			



P.A. - S.p.A. - EQUIPAGGIAMENTI TECNICI DEL LAVAGGIO

VIA MILANO, 13 - CASELLA POSTALE 115 - 42048 RUBIERA (REGGIO EMILIA) - ITALY
Tel. +39 0522 623611 - Fax. +39 0522 629600 - R.E.A. RE 156319 - R.I. RE 11535 - Mecc. RE 013446
C.F. e P.IVA 01035950359 - Cap.Soc. I.V. € 1.500.000,00 - Codice Identificativo C.E.E. IT 01035950359
ART. 2497 - BIS C.C. DIREZIONE E COORDINAMENTO BENETTI srl R.I. TRIB. DI RE 01480690351
<http://www.pa-eti.it> - Email: info@pa-eti.it



GENERAL CONDITIONS OF SALE

1. Introduction

- 1.1. These general conditions apply together with the order confirmation. In the event of a contradiction, the conditions shown on the order confirmation shall prevail.
- 1.2. This Sales Agreement is governed by the United Nations Convention on the International Sale of Goods (Vienna 1980) and, for matters not covered by this convention, by Italian law.
- 1.3. Any reference to commercial terms (such as EXW, FCA etc.) is to be understood as a reference to the Incoterms of the International Chamber of Commerce, in the text in force on the date of signing the Contract.
- 1.4. The following general conditions of sale refer to all products made by P.A. S.p.A. (hereinafter the Seller) present in the catalogue, out of catalogue or made to measure for customers.
- 1.5. For the purposes of interpretation and in case of translation discrepancies between the Italian and English versions, the Italian text shall prevail.

2. Product Features - Changes

- 2.1. Any information or data on the characteristics and technical specifications of the products contained in the brochures, price lists, catalogues or similar documents will be binding only to the extent that such data have been expressly referred to in the Contract.
- 2.2. The Seller reserves the right to make changes to the Products which, without altering the essential characteristics of the Products, should prove necessary or appropriate.

3. Terms of delivery

- 3.1. The delivery date is indicative and not binding. However, if the Seller foresees that he will not be able to deliver the Products on the agreed delivery date, he must promptly notify the Buyer in writing, indicating, where possible, the expected delivery date. It is understood that if the delay attributable to the Seller exceeds 52 weeks, the Buyer may terminate the contract relating to the Products whose delivery is delayed with 10 days' notice to be communicated in writing to the Seller.
 - 3.2. Any delay due to force majeure (as defined in Article 9) or acts or omissions of the Buyer (e.g. failure to provide information necessary for the supply or delivery of the Products) is not considered attributable to the Seller.
 - 3.3. In the event of a delay beyond the term of 52 weeks, the Buyer may request, subject to written formal notice by the Seller, only the return of any advance on the price of the Products not yet delivered.
 - 3.4. Delay in delivery beyond the agreed date or partial fulfillment of the order does not entitle the Buyer to cancel or to claim compensation for direct or indirect damages, or to delay the payment of supplies already made with respect to the agreed deadlines.
- #### 4. Return and Shipping - Complaints
- 4.1. The terms of return shall only be those indicated in the order confirmation.
 - 4.2. In any case, whatever the delivery terms agreed by the parties, the risks pass to the Buyer at the latest with delivery to the first carrier.
 - 4.3. Any complaints relating to the state of the packaging, quantity, number or external characteristics of the Products (apparent defects), must be notified to the Seller in writing, under penalty of forfeiture, within 7 days from the date of receipt of the Products. Any complaints relating to defects not identifiable through a diligent check upon receipt (hidden defects) must be notified to the Seller in writing, under penalty of forfeiture, within 7 days from the date of discovery of the defect and in any case no later than 12 months from delivery to the first carrier.
 - 4.4. It is understood that any complaints or disputes do not entitle the Buyer to suspend or in any case delay payments for the disputed Products, nor for other supplies. It is also forbidden to return the disputed goods without prior agreement with the Seller.

5. Prices

- 5.1. Unless otherwise agreed, the prices are intended for Products packaged according to the uses of the sector in relation to the agreed means of transport, it being understood that any other expense or charge will be borne by the Buyer. List prices are not binding and can be subject to changes depending on increased cost of raw materials, energy and labour.
- 5.2. The seller will have the right to increase the prices agreed upon in the purchase order if unforeseeable events occur which are independent of his will such as to render his performance unreasonably onerous.

6. Terms of payment

- 6.1. Where the parties have agreed on deferred payment, this must be made according to the terms indicated in the order confirmation document. Payment is considered to have been made when the sum becomes available to the Seller at the bank indicated on the invoice.
- 6.2. Where the parties have agreed on advance payment without further information, it is assumed that the advance payment refers to the full price. If payment is not received within 30 days of the Seller's request, the goods will no longer be reserved for the Buyer and will be returned to the Seller's warehouse; the agreed delivery terms will resume starting from the date of payment.
- 6.3. Where the parties have agreed to pay by documentary credit, the Buyer must, unless otherwise agreed, ensure that an irrevocable documentary credit, issued in accordance with the Uniform Customs and Customs of the CCI relating to Documentary Credits (Publication No. 600), is notified to the Seller at least 30 days before the agreed delivery date. Unless otherwise agreed, the irrevocable documentary credit must be confirmed by an Italian bank acceptable to the Seller and be payable at sight.
- 6.4. Unless otherwise agreed, any bank charges or commissions due in connection with the payment shall be borne by the Buyer.
- 6.5. Failure to comply with the agreed payment conditions gives the Seller the right to suspend the fulfillment of new orders.

7. Warranty for defects

- 7.1. The Seller undertakes to remedy any defect, lack of quality or lack of conformity of the Products attributable to him, which occurred within twelve months of delivery to the first carrier of the Products, provided that the same has been promptly notified in accordance with art. 4.3. The Seller may choose whether to repair or replace the Products found to be defective. Products replaced or repaired under warranty will be subject to the same warranty for a period of six months from the date of repair or replacement.
- 7.2. The return of the disputed goods is not permitted without prior agreement with the Seller.
- 7.3. The Seller does not guarantee the compliance of Products with particular specifications or technical characteristics or their suitability for particular uses except to the extent that these characteristics have been expressly agreed in the contract or in documents referred to for this purpose by the Contract itself.
- 7.4. Except in cases of willful misconduct or gross negligence, the Seller will be required, in the event of defects, lack of quality or lack of conformity of the Products, only to repair them or to supply Products to replace the defective ones. It is understood that the aforementioned guarantee (consisting in the obligation to repair or replace the Products) is absorbing and replacing the guarantees or responsibilities provided for by law, and excludes any other liability of the Seller (both contractual and extra-contractual) in any case originating from the Products supplied (to by way of example and not exhaustive: compensation for damage, loss of earnings, withdrawal campaigns, etc...).

8. Retention of title

It is agreed that the Products delivered remain the property of the Seller until full payment is received by the latter.

9. Force majeure

- 9.1. Each party may suspend the execution of its contractual obligations when such execution is made impossible or unreasonably burdensome by an unforeseeable impediment independent of its will such as, but not limited to, strike, boycott, lockout, fire, war (declared or non), civil war, riots and revolutions, requisitions, embargoes, power outages, pandemics.
- 9.2. The party wishing to make use of the force majeure clause must immediately notify the other party in writing of the occurrence and termination of the force majeure circumstances.
- 9.3. If the suspension due to force majeure lasts more than eight weeks, each party will have the right to terminate this Agreement, subject to 10 days' notice to be communicated to the other party in writing.

10. Legislative Decree 231/01 clause

The Buyer declares to have read the contents of the Code of Ethics, and the Organization, Management and Control Model pursuant to Legislative Decree 231/2001 and its Annexes adopted by P.A. S.p.A. by resolution of the Board of Directors of 30th September 2020 and undertakes to observe the related provisions. The Buyer also declares to have been informed that all the aforementioned documentation is available at the Seller's headquarters.

11. Jurisdiction

For any dispute arising from this Agreement or related to it, the Court of the Seller's headquarters, or the Court of Reggio nell'Emilia, will be exclusively competent. However, notwithstanding the above, the Seller still has the right to bring the dispute before the competent Judge at the Buyer's headquarters.



MANAGEMENT SYSTEM CERTIFICATE

Certificate no.:
CERT-02444-98-AQ-BOL-SINCERT

Initial certification date:
05 January 1998

Valid:
08 August 2024 – 07 August 2027

This is to certify that the management system of

P.A. S.p.A.

Via Milano, 13 - 42048 Rubiera (RE) - Italy

and the sites as mentioned in the appendix accompanying this certificate

has been found to conform to the Quality Management System standard:

ISO 9001:2015

This certificate is valid for the following scope:

Design, manufacture, sale and trade of: spray guns, valves, lances, nozzles, electrical components (pressure switches, flow switches and injectors) for high pressure washing; rotary nozzles for tank washers. Design, manufacture, trade of spraying and liquid transfer equipment. Design and manufacture moluds. Moluding plastic material. Manufacture of inox and other metal mechanical items according to customer drawing. (IAF: 18, 14, 17)

Place and date:
Vimercate (MB), 29 July 2024



SCQ N° 603 A
SCA N° 603 B
SCE N° 027 M
SCB N° 034 F

ENAS N° 086 P
PFI N° 003 B
PFI N° 004 C
SIS N° 002 G

Membro di IFA EA per gli schemi di accreditamento
SCQ, SCA, PFI, PFS, ISR, QMS, LAB e LITE di IFA IAF
per gli schemi di accreditamento SCQ, SCA, SCL, PFI
e PFI e di IFA SLAC per gli schemi di accreditamento
LAB, PFI, LIT e ISP

For the issuing office:
DNV - Business Assurance
Via Energy Park, 14, - 20871 Vimercate (MB) -
Italy

Claudia Baroncini
Management Representative

Appendix to Certificate

P.A. S.p.A.

Locations included in the certification are as follows:

Site Name	Site Address	Site Scope
P.A. S.p.A.	Via Milano, 13 - 42048 Rubiera (RE) - Italy	Design, manufacture, sale and trade of: spray guns, valves, lances, nozzles, electrical components (pressure switches, flow switches and injectors) for high pressure washing; rotary nozzles for tank washers. Design, manufacture, trade of spraying and liquid transfer equipment. Design and manufacture molds. Molding plastic material. Manufacture of inox and other metal mechanical items according to customer drawing
P.A. S.p.A. - Stabilimento Operativo di MEC TO S.r.l.	Via Palazzeschi, 13/c - 42122 Bagno di Reggio Emilia (RE) - Italy	Manufacture of inox and other metal mechanical items according to customer drawing
P.A. S.p.A. - Stabilimento Operativo di CHIERICI TITO S.r.l.	Via Palazzeschi, 13/a - 42122 Bagno di Reggio Emilia (RE) - Italy	Design and manufacture molds. Molding plastic material