



Spraying Systems Co.
Experts in Spray Technology

INDUSTRIAL HYDRAULIC SPRAY PRODUCTS





THANK YOU FOR YOUR INTEREST IN OUR SPRAY PRODUCTS

WE'RE LOOKING FORWARD TO HELPING YOU OPTIMIZE YOUR OPERATIONS INVOLVING SPRAY TECHNOLOGY. HERE ARE JUST A FEW WAYS WE CAN ASSIST:

- You'll find the most extensive line of high-quality hydraulic spray products available in this catalog. However, if you don't find exactly what you need, be sure to contact us. Our flexible manufacturing capabilities enable us to make products in additional sizes and materials quickly and efficiently. Special designs are also possible. Just tell us what you need.
- Need a different type of spray solution? Or a spray product for a specific application? Visit spray.com to find additional catalogs on these product lines:
 - Air Atomizing, Automatic Spray Nozzles and Spray System Controllers
 - Handheld GunJet® Spray Guns
 - WindJet® Air Products
 - TankJet® Tank Cleaning Products
 - SprayDry® Nozzles
 - Pulp and Paper Spray Products
 - Steel Industry Spray Products
- On-site sustainability assessments, tank cleaning evaluations, nozzle maintenance workshops and lunch and learn sessions are just a few of the many services we provide. It's easy to take advantage of these programs – just contact your local representative. You'll find a spray expert nearby – we have hundreds of technical sales and service people in more than 90 sales offices around the world.
- Need a device to deliver fluid to your nozzles? Talk to us about headers, manifolds, lances, injectors and more.

These are just a few of the ways we can help you get the results you need from your spray systems; you'll learn about others in the pages that follow. Please be sure to visit spray.com or contact us whenever you need assistance – we're here to serve you.

Thank you – we value your business!













MAKE EVERY DROP COUNT

Visit www.spray.com/results to see how we partner with customers to reduce water, energy and chemical use, minimize waste and scrap, improve worker and food safety and more. This library of case studies includes details on sustainability improvements and resulting benefits. Let us help you make every drop count.



TABLE OF CONTENTS

 What You Can Expect	2
 Spray System Optimization	8
 Selection Guidelines	10
 How to Order and Customer Service	12
 Technical Reference	A1
 Full Cone Nozzles	B1
 Flat Spray Nozzles	C1
 Hollow Cone Nozzles	D1
 Fine Spray Nozzles	E1
 Accessories	F1
 Index	i-1





THE PRODUCTS YOU NEED AND PERFORMANCE YOU CAN COUNT ON

You'll find tens of thousands of hydraulic spray nozzles in this catalog but you can also visit spray.com to see tens of thousands more. Featured products include air atomizing nozzles, automatic hydraulic and pneumatic nozzles, handheld spray guns, tank cleaning equipment, air nozzles and nozzles for specialized operations like descaling, trim squirt, spray drying, fire protection and more. We offer nozzles in more sizes and materials than any other supplier, so you're sure to find a product that delivers the performance you need.

PRECISE, DEPENDABLE PRODUCT QUALITY

Your satisfaction is important to us. Our products are manufactured to exacting standards to deliver the promised performance each and every time you order. We are ISO 9001:2015 and 14001:2015 certified. Products ship only after undergoing our rigorous quality control and testing programs. If you have any concerns about the quality of any of our products, contact us immediately. We will address your issues and take corrective action as needed.

PRODUCTS WHEN YOU NEED THEM

Most of our spray nozzles are readily available and will be shipped within days of your order. If you need expedited service, let us know. Our twelve manufacturing locations are strategically located around the world to help ensure we can get our products where they are needed quickly and cost-effectively.

SPECIAL REQUIREMENTS? TELL US WHAT YOU NEED.

If one of our standard products isn't quite right for your equipment, just let us know. Customization can range from simple changes in materials to specially-designed nozzles to meet exacting performance requirements.

We work with hundreds of OEMs and provide services like these:

- Special nozzle designs
- Private labeling with unique part numbers
- Special packaging
- Customized maintenance and operating instructions



THE SERVICES YOU NEED, WHEN AND WHERE YOU NEED THEM

OUR SOLE FOCUS ON SPRAY TECHNOLOGY ENSURES RESULTS IN YOUR OPERATIONS

Since spray technology is all we do, we have a level of expertise that can't be matched. Our sales engineers are factory-trained and only sell our spray products. Need to increase throughput in a coating operation? Eliminate waste or lower scrap? Cool products more quickly? Suppress dust? Minimize water and chemical use in cleaning operations? Just give us a call. With sales offices on six continents and more than 90 sales offices, we are in your area and ready to help.

WHAT CUSTOMERS SAY ABOUT OUR SERVICE

"We are very pleased with Spraying Systems Co. Wish all vendors were as good."

"Very pleased – awesome is the best way to describe Spraying Systems Co. service."

"A+ on service. Sales engineer responded quickly and visited my facility to review various product options for my application."

"Rep always provides prompt answers. Knows the full product line inside and out."

"I get more technical support from Spraying Systems Co. than any other vendor."

"The local rep came right out – didn't even know the size of the project at the time."

"Spraying Systems Co. provides solutions – not just parts."

"More knowledgeable than any other equipment company we work with."

"We get the products we need, when we need them. Each and every time we order."



WHAT YOU CAN EXPECT – PRECISION

ADDITIONAL EQUIPMENT TO OPTIMIZE SPRAY NOZZLE PERFORMANCE

SPRAY CONTROL

Spray nozzles can only perform properly if the entire spray system is operating efficiently. That's why we offer a wide range of AutoJet® spray controllers. Choose from basic automatic control, monitoring of spray variables or automatic adjustments of spray variables based on what is happening in your process. Adding a spray controller can help:

- Increase production through automation and enable operation at variable line speeds
- Reduce labor costs by eliminating manual operation, system monitoring and changeover of nozzles between batches
- Lower operating costs by eliminating overspray and waste through precision spraying
- Improve worker safety by minimizing exposure to harmful chemicals

Application-specific systems are also part of our offering for more demanding spray operations.

TURNKEY SYSTEM OPTIONS

- AccuCoat® Heated Spray Systems for viscous food coatings
- Precision Spray Control Systems for uniform coverage on the target and nowhere else – even when line speeds change
- AutoJet® Food Safety Systems for the application of antimicrobials and mold inhibitors
- PanelSpray® Systems for engineered wood products
- AutoJet Precision Lubrication Systems for oil application and mold release
- AutoJet Gas Cooling Systems for pollution control

Additional options include systems for dust suppression, NOx control and humidification. Check with your local sales office; system availability may vary by region.



HEADERS AND INJECTORS

The equipment that supplies fluid to spray nozzles can have a big impact on performance. If the fluid flow isn't adequate or the fluid delivery devices aren't suitable for the operating environment, the entire process is in jeopardy. Unlike feed devices built by fabricators or in-house staff, our spray headers, manifolds, showers, injectors, lances and quills are designed to optimize the performance of our spray nozzles and streamline your operations.

You can specify the length, number of nozzles, nozzle spacing and connection type for most of our manifolds and headers. Spray injectors can also be customized. You can specify nozzle type, nozzle placement, materials, coatings and any specialized testing required.

The next time you order spray nozzles, take a moment to consider your fluid delivery equipment. Talk to your local sales engineer about ways to ensure optimal performance and streamline operations.

PRODUCT OPTIONS INCLUDE:

- Basic spray nozzle manifolds with a C-channel to facilitate spray nozzle set-up and adjustment
- Pipe-in-pipe spray manifolds with nozzles mounted inside a slotted pipe for protection against build-up and damage
- Modular spray manifolds with easy-to-access tubing and fittings to simplify set-up and cleaning
- Built-to-order spray manifolds
- Automatic brush showers that keep nozzles clean without process interruption or maintenance downtime
- Built-to-order spray injectors for use in demanding environments such as refineries, power plants and chemical production
- Spray quills and lances for use in environments where spray performance is less critical



PERFORMANCE VALIDATION BEFORE YOU BUY

TESTING SERVICES HELP ENSURE PRECISION SPRAY PERFORMANCE

In new spray applications or applications where spray performance is critical, it is important to understand how factors like these affect performance:

- Operating conditions such as pressure, temperature and variable line speeds
- The liquid being sprayed
- The placement and position of nozzles in relation to the target

In many cases, experience and theoretical calculations can provide an indication of actual spray performance. However, testing in our spray labs determines actual performance and can eliminate costly specification mistakes or quality problems after installation. During testing, we can adjust operating conditions and/or test different nozzles until we find the exact spray performance required in your application.

Common tests include:

- | | |
|--------------------------|--------------------|
| • Spray characterization | • Spray angle |
| • Drop size distribution | • Evaporation rate |
| • Spray impact | • Residence time |
| • Spray pattern | • Dwell time |
| • Spray coverage | |

A LOOK INSIDE OUR LABS

Evaluating sprays requires very specialized equipment. In fact, some of our equipment was designed by our spray engineers and is used only in our facilities. Our test equipment includes:

- Spray patternators to measure spray distribution
- Impact testers to determine impact throughout a spray
- Laser diffraction and Phase Doppler particle size analyzers to measure drop size and spray velocity
- Laser sheet imaging analyzers to evaluate spray shape and distribution
- Wind tunnel to determine the effects of air currents and gas flows on sprays





ADVANCED MODELING SERVICES AND MANUFACTURING CAPABILITIES FOR COMPLEX AND DEMANDING APPLICATIONS

It is not feasible to replicate operating conditions for every application. Gas cooling, chemical injection, spray drying and tablet coating are just a few applications where we cannot spray the liquids used for safety reasons or procure comparable process equipment. Yet, in these applications, understanding spray performance is often critical to process efficiency, product quality, equipment longevity and even worker safety. That’s when we use sophisticated modeling tools to predict spray performance.

- Computational Fluid Dynamics (CFD) models illustrate flow patterns, velocity, temperature, gas/liquid distributions, droplet trajectories, internal system pressure and more in scrubbers, towers, ducts and dryers. Our models use data we’ve collected in our spray labs to reduce the error factor and precisely predict spray performance
- Fluid Structure Interaction (FSI) examines the interaction between fluid dynamics and structural integrity. This enables us to determine the materials required to withstand mechanical stresses such as load, pressure, turbulence, corrosion and more

Demanding applications often require the use of special materials and compliance with various manufacturing codes and testing standards. We can produce nozzles, quills, injectors and headers to exacting standards and conduct a wide range of tests to validate construction.

MANUFACTURING AND TESTING CAPABILITIES

Manufacturing:

- ASME® Boiler and Pressure Vessel Code
- ASME B31.1 Power Piping Code
- ASME B31.3 Process Piping Code
- Welding to ASME B&PV Code Section IX
- cGMP
- Canadian Registration Number requirements

Testing in accordance with ANSI®, ASTM® standards:

- Ultrasonic
- Radiographic
- Liquid penetrant
- Hardness
- Hydrostatic
- Magnetic particle examination
- Positive material identification

See Trademark Registration and Ownership, page i-1.

Learn more about our testing and modeling services at sprayanalysis.com



SPRAY SYSTEM OPTIMIZATION

HOW YOU CAN BENEFIT FROM SPRAY SYSTEM OPTIMIZATION

WAYS TO LEARN MORE
EXPERT ADVICE AT YOUR PLANT

Sustainability Assessments – Invite our team of experts to evaluate your cooling, coating, cleaning, drying, mixing or other operations. We will identify ways to:

- Reduce water, chemical and energy use
- Reduce scrap and waste
- Reduce risk and improve safety

Complimentary Lunch and Learn workshops –

Select a topic, choose a date and invite your colleagues. We'll provide lunch and an informative 60-minute session. Popular topics include *Spray Nozzle Basics*, *Understanding Drop Size* and *How to Reduce Use of Costly Chemicals*.

Spray demos and proof-of-concept trials at your facility –

Your local sales engineer will conduct demos and tests on-site so you can see how a product will work in your environment. When operating conditions don't allow an on-site demo or test, other arrangements can be made.

TESTS AND DEMONSTRATIONS AVAILABLE AT REGIONAL SPRAY TECHNOLOGY CENTERS

Throughout North America, we have several Spray Technology Centers. These facilities are equipped to conduct proof-of-concept tests and technology demonstrations. Seminars including live demonstrations on various topics are also conducted throughout the year. Schedules vary by region so contact your local sales engineer for information.

MULTI-DAY SEMINARS FOR ADVANCED LEARNING

An in-depth seminar on the atomization and spraying of liquids is conducted twice a year at our facility in Wheaton, IL. Attendees spend time in the classroom and our fully equipped spray laboratories and participate in spray characterization tests. More information is available from your local sales engineer and at sprayanalysis.com.





EDUCATIONAL RESOURCES

Video demonstrations and tutorials on spray.com and [YouTube.com/sprayingystems](https://www.youtube.com/sprayingystems)

Explore our video library and learn about new spray products and techniques; best practices in maintenance procedures; what to look for in a spray pattern and more.

Informational reference material on spray.com

- *Optimizing Your Spray System*, Technical Manual 410
- *Three Simple Ways to Dramatically Reduce Water Use*, White Paper 116
- *Dramatically Reduce Chemicals, Lubricants & Other Coatings Without Compromising Quality*, White Paper 117
- Plus a wide range of industry- and application-specific technical bulletins filled with selection, optimization and maintenance tips

Case studies on spray.com

More than 200 case studies demonstrate how processors have improved operating sustainability, increased production and lowered costs by optimizing cooling, coating, cleaning, lubricating, drying and other applications using our spray technology. See spray.com/results.

Catalogs on spray.com

- Air Atomizing and Automatic Air Atomizing Nozzles
- Hydraulic Nozzles
- TankJet® Tank Cleaning Products
- WindJet® Air Products
- SprayDry® Nozzles
- Spray Technology for Steelmaking
- Spray Technology for Pulp and Papermaking
- Car Wash Products
- GunJet® Handheld Spray Guns

SELECTION GUIDELINES

Use this general guide as a starting point if you're not sure which type of nozzle to use in your spray operation. However, keep in mind that performance varies based on operating conditions, so be sure to contact your local representative for assistance.

ABSORBER TOWERS

FullJet®, SpiralJet® and DistribroJet® full cone nozzles	Section B
WhirlJet® hollow cone nozzles	Section D



AIR PRODUCTS

See **spray.com** for information on WindJet® compressed air and blower-powered air knife packages.



AIR WASH

FullJet and SpiralJet full cone nozzles	Section B
WhirlJet hollow cone nozzles	Section D



AIRLESS SPRAYING

See **spray.com** for information on automatic spray nozzles and tungsten carbide spray nozzles.



AUTOMATED SPRAYING

See **spray.com** for information on automatic spray nozzles, AutoJet® spray controllers and turnkey spray systems for precision coating, gas cooling, lubrication and more.



CLEANING: TANK

See **tankjet.com** for information on our full line of TankJet® tank cleaning equipment.



COATINGS AND ADDITIVES

Fine spray nozzles	Section E
VeeJet® flat spray nozzles	Section C
WhirlJet hollow cone nozzles	Section D

See **spray.com** for additional information on air atomizing nozzles, automatic spray nozzles and turnkey coating systems.



COOLING: IN PROCESS

FullJet and SpiralJet full cone nozzles	Section B
FloodJet® flat spray nozzles	Section C
WhirlJet hollow cone nozzles	Section D



COOLING: GAS

SpiralJet full cone nozzles	Section B
SpiralJet and WhirlJet hollow cone nozzles	Section D

See **spray.com** for additional information on two-fluid nozzles for gas cooling and turnkey gas cooling and pollution control systems.



DESCALING

See **spray.com** for information on descaling and other spray products for steelmaking.



DUST CONTROL

WhirlJet® hollow cone nozzles	Section D
SpiralJet® full cone nozzles	Section B
Fine spray nozzles	Section E



ETCHING AND RINSING

ProMax® Quick VeeJet and FloodJet® flat spray nozzles	Section C
FullJet® full cone nozzles	Section B



FIRE PROTECTION

SpiralJet and FullJet full cone nozzles	Section B
FloodJet flat spray nozzles	Section C



FOAM CONTROL

FloodJet flat spray nozzles	Section C
FullJet and SpiralJet full cone nozzles	Section B



HUMIDIFICATION

See spray.com for information on air atomizing and automatic spray nozzles.



SCRUBBERS: GAS CONDITIONING

See spray.com for information on two-fluid nozzles for gas cooling, spray injectors for gas conditioning and turnkey gas cooling and pollution control systems.



SCRUBBERS – WET

WhirlJet and SpiralJet hollow cone nozzles	Section D
FullJet and SpiralJet full cone nozzles	Section B



SPRAY DRYING

See spray.com for information on SprayDry® nozzles.



SPRAY PONDS – EVAPORATING AND COOLING

WhirlJet and SpiralJet hollow cone nozzles	Section D
FullJet and SpiralJet full cone nozzles	Section B



WASHING – CONVEYOR

VeeJet®, FlatJet® and FloodJet flat spray nozzles	Section C
FullJet full cone nozzles	Section B
SpiralJet hollow cone nozzles	Section D



WASHING – MIST ELIMINATOR

FullJet full cone nozzles	Section B
SpiralJet hollow cone nozzles	Section D



WASHING – PARTS

VeeJet, WashJet® and ProMax Quick VeeJet flat spray nozzles	Section C
ProMax Quick FullJet full cone nozzles	Section B



HOW TO ORDER AND CUSTOMER SERVICE



ORDERING PRODUCTS

In each product section, you'll find ordering examples. Start by reviewing the example and then create the part number by indicating the inlet connection, material and capacity size.

Inlet Conn.	Nozzle Type	—	Material Code	Capacity Size	Example	1/4	G	—	SS	10
-------------	-------------	---	---------------	---------------	---------	-----	---	---	----	----

For your convenience, there are multiple ways to place an order: phone, fax and online.

In the U.S. and Canada

Phone: 1.800.95.SPRAY | Fax: 1.888.95.SPRAY

Outside the U.S. and Canada

Phone: 1.630.665.5000 | Fax: 1.630.260.0842

Online ordering with a credit card is also available. Visit spray.com/ispray. You'll find helpful selection tools and a Live Chat option for immediate assistance.

FINDING PRODUCTS

- Consult the Product Index on **page i-4** if you know the name of the product
- Consult the Part Number Index on **page i-8** if you have the part number. Part numbers are shown numerically and alpha-numerically
- If you're not sure what you need, our Selection Guidelines on **pages 10-11** will help you identify products typically used in dozens of applications

Selection assistance is also available by calling **1.800.95.SPRAY**. Representatives in your local sales office will help you determine which products best meet your application requirements. (Call **1.630.665.5000** outside North America or visit spray.com to find information for the sales office in your area.)

TECHNICAL REFERENCE
TABLE OF CONTENTS

	Basic Nozzle Characteristics	A2
	Capacity and Specific Gravity	A5
	Spray Performance Considerations	A6
	Pump Selection Guidelines	A7
	Spray Drop Size	A8
	Drop Size Terminology and Impact	A9
	Operating Pressure and Nozzle Materials	A10
	Viscosity, Temperature and Surface Tension	A11
	Pressure Drop	A12
	Maintenance Tips	A14
	Weights, Measurements and Formulas	A15
	General Safety Instructions	A16



Spray nozzles are precision components designed to yield very specific performance under specific conditions. To help you determine the best nozzle type for your application, the following chart summarizes the performance that each nozzle type is designed to deliver. Visit [youtube.com/sprayingystems](https://www.youtube.com/sprayingystems) for video demonstrations of spray patterns.

The spray pattern images on the right were acquired in our spray laboratories using Laser Sheet Imaging (LSI). LSI images are collected by passing a laser sheet through a cross-section of the spray plume and imaging with a light-filtered camera. The distributions are directly proportional to the surface area distribution of the sprayed material (red: high; blue: low; black: zero). Volume distributions typically are similar to surface area distributions for these nozzles, depending on the local drop size distributions.



FULL CONE NOZZLES

- Uses a unique internal vane design to produce a solid cone-shaped spray pattern
- Spray pattern consists of medium- to large-sized drops

Typical applications:

- Chemical injection
- Dust suppression
- Fire protection
- Metal cooling
- Washing/rinsing

LASER SHEET IMAGE

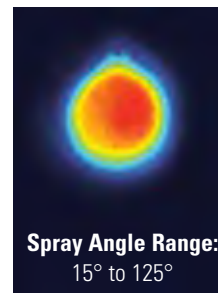

FULL CONE (SPIRAL-TYPE) NOZZLES

- Produces a solid cone-shaped spray pattern when the fluid exits the voids in the spiral
- Spray pattern is not as uniform as full cone nozzles with an internal vane
- Spray pattern consists of relatively coarse drops

Typical applications:

- Dust suppression
- Fire protection
- Flue gas desulfurization (FGD)
- Quenching

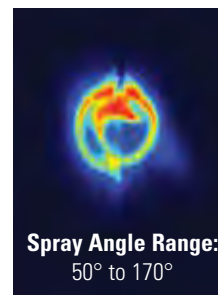

FULL CONE (OVAL SPRAY) NOZZLES

- Uses a unique internal vane to produce a solid cone-shaped spray pattern with oval impact area with a width approximately one-half its length
- Spray pattern consists of medium- to large-sized drops

Typical applications:

- Air/gas washing
- Cooling and quenching
- Dust control
- Fire suppression



FULL CONE (SQUARE SPRAY) NOZZLES

- Uses a unique internal vane to produce a solid cone-shaped spray with square impact area
- Spray pattern is uniform across entire spray area
- Spray pattern consists of medium- to large-sized drops

Typical applications:

- Air/gas washing
- Cooling and quenching
- Dust control
- Fire suppression

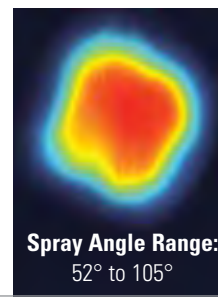

BASIC NOZZLE CHARACTERISTICS

TECHNICAL REFERENCE



FLAT (EVEN) NOZZLES

- Provides even distribution of medium-sized drops throughout the thin, rectangular spray pattern
- When used on a header, nozzles are positioned for edge-to-edge pattern contact

Typical applications:

- Coating
- Cooling
- Moisturizing
- Washing

LASER SHEET IMAGE



FLAT SPRAY (TAPERED) NOZZLES

- Produces a tapered-edge flat spray pattern
- Used on spray headers to provide uniform coverage as a result of overlapping distributions

Typical applications:

- Descaling
- High-pressure cleaning
- Label removal

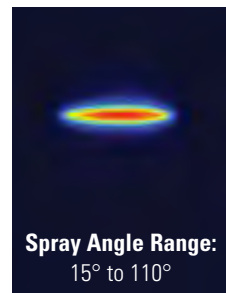

FLAT SPRAY (DEFLECTED-TYPE) NOZZLES

- Uses a deflector surface to form an even flat spray pattern consisting of medium-sized drops
- Large free passage design reduces clogging through the round orifice

Typical applications:

- Showers in papermaking
- Washing

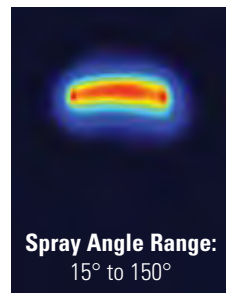

HOLLOW CONE (WHIRLCHAMBER-TYPE) NOZZLES

- Uses a whirlchamber to rotate the fluid and produce a circular spray pattern
- Ideal for use when a combination of small drop size and higher capacity is needed

Typical applications:

- Air, gas and water cooling
- Cooling products on conveyors
- Dust control
- Flue gas desulfurization (FGD)
- Water aeration



HOLLOW CONE (DEFLECTED-TYPE) NOZZLES

- Uses a deflector cap to form an umbrella-shaped hollow cone pattern

Typical applications:

- Decorative spray
- Dust suppression
- Fire protection
- Flush cleaning of tube/pipe interiors
- Water curtain

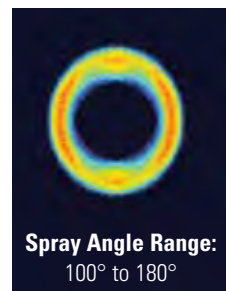



HOLLOW CONE (SPIRAL-TYPE) NOZZLES

- Produces a circular spray pattern when the fluid exits the voids in the spiral
- Drops are slightly coarser than those in other hollow cone sprays
- Provides a high flow rate in a compact nozzle size
- One-piece design produces maximum throughput for a given pipe size

Typical applications:

- Dust suppression
- Fire protection
- Flue gas desulfurization (FGD)

LASER SHEET IMAGE

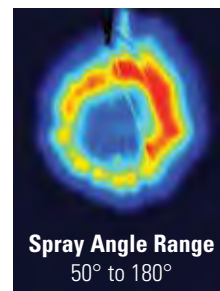

SOLID STREAM NOZZLES

- Produces a solid stream spray with the highest impact per unit area

Typical applications:

- Cleaning products when complete removal of dirt and debris is required
- Decorative spray ponds
- Laminar flow operations

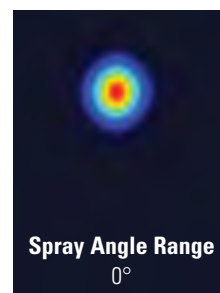

ATOMIZING (HYDRAULIC, FINE MIST) NOZZLES

- Produces a finely atomized, low capacity spray in a hollow cone pattern without use of compressed air

Typical applications:

- Dust suppression
- Evaporative cooling
- Moisturizing
- Spray drying

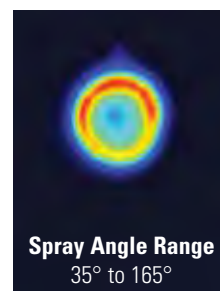

AIR ATOMIZING AND AIR ASSISTED NOZZLES

- Produces a variety of cone and flat spray patterns through atomization of liquid by compressed air
- Internal mix impingement atomization forms very fine drops

Typical applications:

- Coating
- Evaporative cooling
- Humidification
- Moisturizing

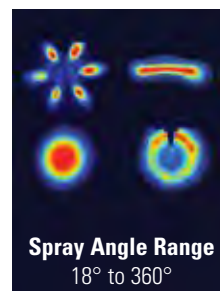

CAPACITY – FLUID CAPACITY VARIES WITH SPRAYING PRESSURE

The relationship of pressure and flow with a given orifice is:

$$\frac{Q_1}{Q_2} \sim \frac{(P_1)^n}{(P_2)^n}$$

Q = Flow Rate (in gpm or lpm)
P = Liquid pressure (in psi or bar)
n = Flow exponent

To approximate any unknown flow or pressure, use this formula when the other variables are known. The "n" exponent is used to approximate the ratio of pressure to flow based on the type of spray pattern.

Example:

To determine the flow rate of water for a 1/4G-10 standard full cone nozzle at 150 psi or at 10 bar, consult the performance charts in this catalog.

You will find that:

- The spray angle is 65°
- Flow (Q₁) at 40 psi = 1.9 gpm
- Pressure (P₁) = 40 psi
- Pressure (P₂) = 150 psi

Solving for Q₂ = 3.5 gpm

$$Q_2 = \frac{Q_1}{(P_1/P_2)^n} = \frac{1.9 \text{ gpm}}{(40/150)^{.46}}$$

- The spray angle is 65°
- Flow (Q₁) at 3 bar = 7.5 lpm
- Pressure (P₁) = 3 bar
- Pressure (P₂) = 10 bar

Solving for Q₂ = 13 lpm

$$Q_2 = \frac{Q_1}{(P_1/P_2)^n} = \frac{7.5 \text{ lpm}}{(3/10)^{.46}}$$

FLOW EXPONENT FOR SPECIFIC NOZZLE TYPES

Nozzle Type	Exponent "n"
Hollow Cone Nozzles – All Full Cone Nozzles – Vaneless, 15° and 30° Series Flat Spray Nozzles – All Solid Stream Nozzles – All Spiral Nozzles – All	.50
Full Cone Nozzles – Standard, Square, Oval and Large Capacity	.46
Full Cone Nozzles – Wide Spray and Wide Square Spray	.44

Visit spray.com/sprayware for online flow rate and spray coverage calculators.

SPECIFIC GRAVITY

All capacity tabulations in this catalog are based on water.

Since the specific gravity of a liquid affects its flow rate, tabulated catalog capacities must be multiplied by the conversion factor that applies to the specific gravity of the liquid being sprayed as explained below.

Specific gravity is the ratio of the density of a fluid compared to the density of water. The specific gravity of water is defined as 1. When spraying fluids other than water, specific gravity must be considered in the flow calculations.

$$Q_2 = Q_1(\text{water}) \times \frac{1}{\sqrt{SG}}$$

Using the previous example:

- Fluid sprayed is heavier than water and has a specific gravity of 1.4
- Flow of water at 150 psi = 3.5 gpm
- Heavy fluid (Q₂) = Q₁(water)*1/√1.4

$$Q_2 = \frac{3.5 \text{ gpm} * 1}{\sqrt{1.4}} = 2.95 \text{ gpm}$$

- Fluid sprayed is heavier than water and has a specific gravity of 1.4
- Flow of water at 10 bar = 13 lpm
- Heavy fluid (Q₂) = Q₁(water)*1/√1.4

$$Q_2 = \frac{13 \text{ lpm} * 1}{\sqrt{1.4}} = 11 \text{ lpm}$$

SPECIFIC GRAVITY VERSUS CONVERSION FACTOR

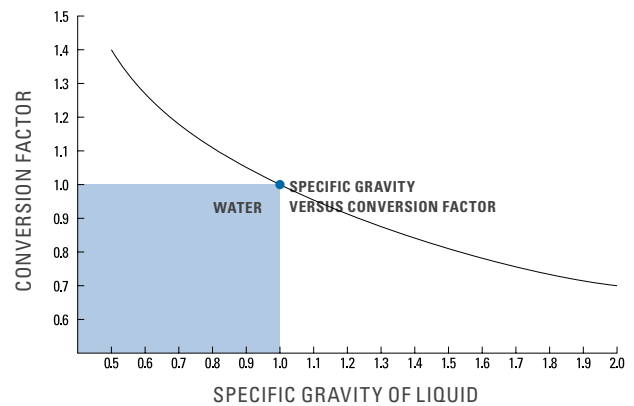

KEY: Conversion factor multiplied by the capacity of the nozzle when spraying water gives the capacity of the nozzle when spraying a liquid with a specific gravity corresponding to the conversion factor. This conversion factor accounts only for the effect of specific gravity on capacity and does not account for other factors affecting capacity.

SPRAY ANGLE AND COVERAGE

Tabulated spray angles indicate approximate spray coverage based on spray or distribution of water. In actual spraying, the effective spray angle varies with spray distance. Liquids more viscous than water form relatively smaller spray angles (or even a solid stream), depending upon viscosity, nozzle capacity and spraying pressure. Liquids with surface tensions lower than water will produce relatively wider spray angles than those listed for water. This table lists the theoretical coverage of spray patterns as calculated from the included spray angle of the spray and the distance from the nozzle orifice. Values are based on the assumption that the spray angle remains the same throughout the entire spray distance. In actual practice, the tabulated spray angle does not hold for long spray distances. If the spray coverage requirement is critical, request data sheets for specific spray coverage data.

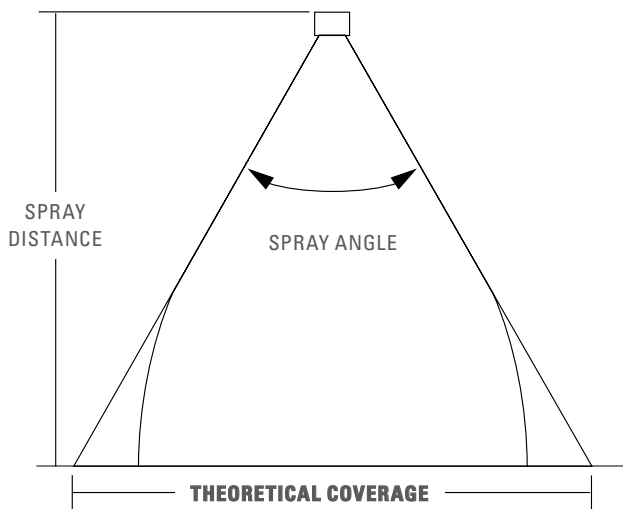

Example: A spray nozzle with an angle of 65° spraying 15" (39 cm) from the target provides 19.2" (48.8 cm) of coverage

THEORETICAL SPRAY COVERAGE AT VARIOUS DISTANCES IN INCHES (CM) FROM NOZZLE ORIFICE

Spray Angle	2 in.	5 cm	4 in.	10 cm	6 in.	15 cm	8 in.	20 cm	10 in.	25 cm	12 in.	30 cm	15 in.	40 cm	18 in.	50 cm	24 in.	60 cm	30 in.	70 cm	36 in.	80 cm	48 in.	100 cm
5°	.2	.4	.4	.9	.5	1.3	.7	1.8	.9	2.2	1.1	2.6	1.3	3.5	1.6	4.4	2.1	5.2	2.6	6.1	3.1	7.0	4.2	8.7
10°	.4	.9	.7	1.8	1.1	2.6	1.4	3.5	1.8	4.4	2.1	5.3	2.6	7.0	3.1	8.8	4.2	10.5	5.2	12.3	6.3	14.0	8.4	17.5
15°	.5	1.3	1.1	2.6	1.6	4.0	2.1	5.3	2.6	6.6	3.2	7.9	3.9	10.5	4.7	13.2	6.3	15.8	7.9	18.4	9.5	21.1	12.6	26.3
20°	.7	1.8	1.4	3.5	2.1	5.3	2.8	7.1	3.5	8.8	4.2	10.6	5.3	14.1	6.4	17.6	8.5	21.2	10.6	24.7	12.7	28.2	16.9	35.3
25°	.9	2.2	1.8	4.4	2.7	6.7	3.5	8.9	4.4	11.1	5.3	13.3	6.6	17.7	8.0	22.2	10.6	26.6	13.3	31.0	15.9	35.5	21.2	44.3
30°	1.1	2.7	2.1	5.4	3.2	8.0	4.3	10.7	5.4	13.4	6.4	16.1	8.1	21.4	9.7	26.8	12.8	32.2	16.1	37.5	19.3	42.9	25.7	53.6
35°	1.3	3.2	2.5	6.3	3.8	9.5	5.0	12.6	6.3	15.8	7.6	18.9	9.5	25.2	11.3	31.5	15.5	37.8	18.9	44.1	22.7	50.5	30.3	63.1
40°	1.5	3.6	2.9	7.3	4.4	10.9	5.8	14.6	7.3	18.2	8.7	21.8	10.9	29.1	13.1	36.4	17.5	43.7	21.8	51.0	26.2	58.2	34.9	72.8
45°	1.7	4.1	3.3	8.3	5.0	12.4	6.6	16.6	8.3	20.7	9.9	24.9	12.4	33.1	14.9	41.4	19.9	49.7	24.8	58.0	29.8	66.3	39.7	82.8
50°	1.9	4.7	3.7	9.3	5.6	14.0	7.5	18.7	9.3	23.3	11.2	28.0	14.0	37.3	16.8	46.6	22.4	56.0	28.0	65.3	33.6	74.6	44.8	93.3
55°	2.1	5.2	4.2	10.4	6.3	15.6	8.3	20.8	10.3	26.0	12.5	31.2	15.6	41.7	18.7	52.1	25.0	62.5	31.2	72.9	37.5	83.3	50.0	104
60°	2.3	5.8	4.6	11.6	6.9	17.3	9.2	23.1	11.5	28.9	13.8	34.6	17.3	46.2	20.6	57.7	27.7	69.3	34.6	80.8	41.6	92.4	55.4	115
65°	2.5	6.4	5.1	12.7	7.6	19.1	10.2	25.5	12.7	31.9	15.3	38.2	19.2	51.0	22.9	63.7	30.5	76.5	38.2	89.2	45.8	102	61.2	127
70°	2.8	7.0	5.6	14.0	8.4	21.0	11.2	28.0	14.0	35.0	16.8	42.0	21.0	56.0	25.2	70.0	33.6	84.0	42.0	98.0	50.4	112	67.2	140
75°	3.1	7.7	6.1	15.4	9.2	23.0	12.3	30.7	15.3	38.4	18.4	46.0	23.0	61.4	27.6	76.7	36.8	92.1	46.0	107	55.2	123	73.6	153
80°	3.4	8.4	6.7	16.8	10.1	25.2	13.4	33.6	16.8	42.0	20.2	50.4	25.2	67.1	30.3	83.9	40.3	101	50.4	118	60.4	134	80.6	168
85°	3.7	9.2	7.3	18.3	11.0	27.5	14.7	36.7	18.3	45.8	22.0	55.0	27.5	73.3	33.0	91.6	44.0	110	55.0	128	66.0	147	88.0	183
90°	4.0	10.0	8.0	20.0	12.0	30.0	16.0	40.0	20.0	50.0	24.0	60.0	30.0	80.0	36.0	100	48.0	120	60.0	140	72.0	160	96.0	200
95°	4.4	10.9	8.7	21.8	13.1	32.7	17.5	43.7	21.8	54.6	26.2	65.5	32.8	87.3	39.3	109	52.4	131	65.5	153	78.6	175	105	218
100°	4.8	11.9	9.5	23.8	14.3	35.8	19.1	47.7	23.8	59.6	28.6	71.5	35.8	95.3	43.0	119	57.2	143	71.6	167	85.9	191	114	238
110°	5.7	14.3	11.4	28.6	17.1	42.9	22.8	57.1	28.5	71.4	34.3	85.7	42.8	114	51.4	143	68.5	171	85.6	200	103	229	-	286
120°	6.9	17.3	13.9	34.6	20.8	52.0	27.7	69.3	34.6	86.6	41.6	104	52.0	139	62.4	173	83.2	208	104	243	-	-	-	-
130°	8.6	21.5	17.2	42.9	25.7	64.3	34.3	85.8	42.9	107	51.5	129	64.4	172	77.3	215	103	257	-	-	-	-	-	-
140°	10.9	27.5	21.9	55.0	32.9	82.4	43.8	110	54.8	137	65.7	165	82.2	220	98.6	275	-	-	-	-	-	-	-	-
150°	14.9	37.3	29.8	74.6	44.7	112	59.6	149	74.5	187	89.5	224	112	299	-	-	-	-	-	-	-	-	-	-
160°	22.7	56.7	45.4	113	68.0	170	90.6	227	113	284	-	-	-	-	-	-	-	-	-	-	-	-	-	-
170°	45.8	114	91.6	229	-	-	-	-	-	-	-	-	-	-	-	-	-	-	-	-	-	-	-	-

Visit spray.com/sprayware for online flow rate and spray coverage calculators.



PUMPS

Every operation using spray nozzles requires a method to provide fluid flow. Fluid flow can be provided by gravity, air pressure or mechanical pumps. It is important to understand that pumping systems provide flow, not pressure. Pressure is the result of restricting flow. The output of an unrestricted pump is 0 psi (bar). When a restriction is placed in the flow, line pressure will result.

The main types of pumps are positive displacement and centrifugal. There are others, but the operational principles are the same as for positive displacement and centrifugal pumps.

Positive displacement pumps

A fixed volume of fluid is delivered for every stroke of a piston, or plunger or rotation of a shaft. Examples include piston pumps, plunger pumps, peristaltic pumps and gear pumps. Positive displacement pumps provide high pressure, and regardless of the system characteristics, will deliver a fixed flow every rotation. These pumps must have an unrestricted bypass valve and a pressure relief valve.

Centrifugal pumps (velocity pumps)

These pumps typically consist of a large vane (impeller) which is turned by a shaft inside a cavity (casing). The geometry of the impeller and casing moves the fluid in a tangential motion. The fluid gets restricted to a smaller volume and is then discharged into the system piping. These types of pumps typically operate at low pressure and high volume. They may also consist of several stages to increase the number of pressures available. These pumps have the unique feature of being able to run while the outlet is blocked. Since the pumps are velocity based, the impeller will spin in the casing fluid without “dead heading” the system itself. It will produce heat and may cavitate the fluid, but it will not build pressure like positive displacement pumps. However, a system bypass and pressure safety valve is still installed in the system to protect components.

HOW PUMP TYPE AFFECTS NOZZLE SELECTION

The flow rates and pressures required by the system will determine the pump choice. There are many styles, sizes and types of pumps available but these general guidelines should prove helpful.

- High flows usually require a centrifugal style pump
- High pressures usually require a positive displacement pump
- Variable Frequency Drive (VFD) pumps may be an option. These pumps allow variable control of speed and flow rates
- Consider the fluid. Specific gravity will affect pump flow rates just as it affects nozzle flow rates
- Pump efficiencies, heat, available power, maintenance and plant conditions should also be considered

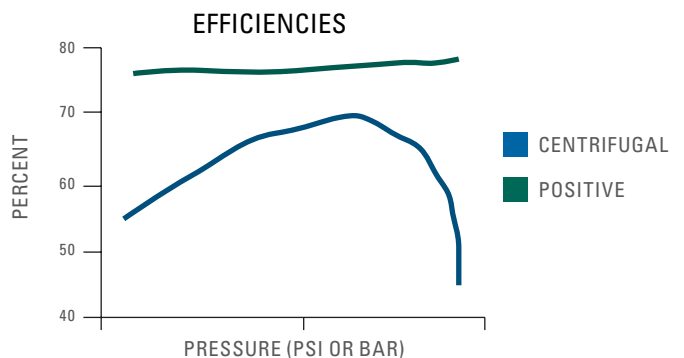
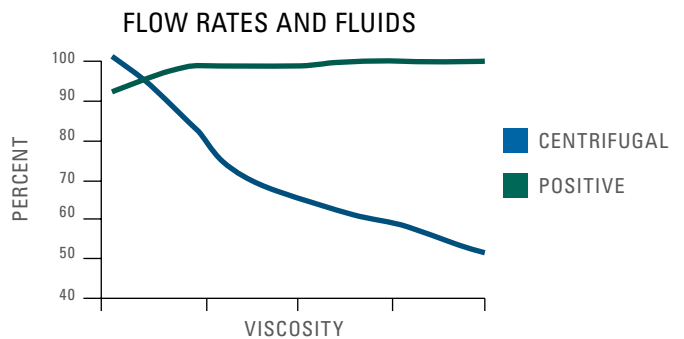
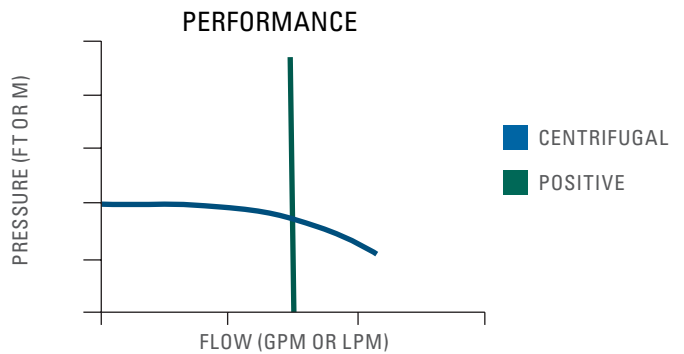

SPRAY DROP SIZE (ATOMIZATION)

Accurate drop size information is an important factor in optimizing spray nozzle performance, particularly in industrial applications such as gas cooling, gas conditioning, fire suppression and spray drying.

Drop size refers to the size of the individual spray drops that comprise a nozzle’s spray pattern. Each spray provides a range of drop sizes; this range is referred to as drop size distribution. Drop size distribution is dependent on the spray pattern type and varies significantly from one type to another. The smallest drop sizes are achieved by air atomizing nozzles while the largest drops are produced by full cone hydraulic spray nozzles.

ACTUAL DROP SIZES

- 500 µm
- 1200 µm
- 5500 µm

One inch = 25,400 µm

One millimeter = 1,000 µm

µm = micrometers

Liquid properties, nozzle capacity, spraying pressure and spray angle also affect drop size. Lower spraying pressures provide larger drop sizes. Conversely, higher spraying pressures yield smaller drop sizes. Within each type of spray pattern the smallest capacities produce the smallest spray drops, and the largest capacities produce the largest spray drops.

DROP SIZE BY SPRAY PATTERN TYPE AT VARIOUS PRESSURES AND CAPACITIES

Spray Pattern Type	10 psi (0.7 bar)			40 psi (2.8 bar)			100 psi (7 bar)		
	Capacity		VMD	Capacity		VMD	Capacity		VMD
	gpm	lpm	microns	gpm	lpm	microns	gpm	lpm	microns
Air Atomizing	.005 .02	.02 .08	20 100	.008 8	.03 30	15 200	12	45	400
Fine Spray	.22	.83	375	.03 .43	.1 1.6	110 330	.05 .69	.2 2.6	110 290
Hollow Cone	.05 12	.19 45	360 3400	.10 24	.38 91	300 1900	.16 38	.61 144	200 1260
Flat Fan	.05 5	.19 18.9	260 4300	.10 10	.38 38	220 2500	.16 15.8	.61 60	190 1400
Full Cone	.10 12	.38 45	1140 4300	.19 23	.72 87	850 2800	.30 35	1.1 132	500 1720

Based on a sampling of nozzles selected to show the wide range of possible drop sizes available.

RELATIVE DROP SIZE

General drop size categories are used throughout this catalog. Actual drop size will vary based on flow rate and pressure, so for some nozzles, more than one drop size category is shown. If drop size is critical in your application, contact us for specific information.

IN MICRONS

<p>FOG</p>  <p>10 to 100</p>	<p>LIGHT RAIN</p>  <p>100 to 500</p>	<p>MODERATE RAIN</p>  <p>500 to 1000</p>	<p>INTENSE/HEAVY RAIN</p>  <p>1000 to 5000</p>
VERY SMALL	SMALL	MEDIUM	LARGE

DROP SIZE TERMINOLOGY

Terminology is often a major source of discrepancy and confusion in understanding drop size. To accurately compare drop sizes from one nozzle to another, the same diameters have to be used. Drop size is usually expressed in microns (micrometers). Following are the most popular characteristic diameters and their definitions.

D_{v0.5} : VOLUME MEDIAN DIAMETER (VMD)

A means of expressing drop size in terms of the volume of liquid sprayed. The Volume Median Diameter drop size when measured in terms of volume is a value where 50% of the total volume of liquid sprayed is made up of drops with diameters larger than the median value and 50% with smaller diameters.

D_{v0.9}

A value where 90% of the total volume of liquid sprayed is made up of drops with diameters smaller or equal to this value. This measurement is best suited when complete evaporation of the spray is required.

D₃₂ : SAUTER MEAN DIAMETER (SMD)

A means of expressing the fineness of a spray in terms of the surface area produced by the spray. The Sauter Mean Diameter is the diameter of a drop having the same volume-to-surface area ratio as the total volume of all the drops to the total surface area of all the drops.

More drop size data is available on all types of spray nozzles. For more information contact your local Spraying Systems Co. sales engineer.

IMPACT

Impact, is the measure of force imparted on a surface by a spray pattern at a given distance. It can be expressed in several ways. All definitions are derived from the most basic equation of total impact force. This is the force that any flow, at any pressure, is capable of making on a surface. This does not account for orifice shape, nozzle type, fluid properties and other factors.

$$I = K \times Q \times \sqrt{P}$$

Total theoretical impact = constant (based on units) x flow (at pressure P) x square root of pressure (P)

I = total theoretical spray impact

K = constant

Q = flow rate

P = liquid pressure

I	lbs.(f)	kg(f)	Newtons	Newtons
K	.0526	.024	.24	.745
Q	gpm	lpm	lpm	lpm
P	psi	kg/cm ²	bar	MPa

The constant (K), is a unit conversion based on the measurement system used. The conversions are listed in the chart above.

Example:

$$I = .0526 \times 3.5 \text{ gpm} \times \sqrt{150 \text{ psi}}$$

I = 2.25 lbs(f) is available for distribution throughout the pattern

Contact your local sales engineer for assistance in determining impact in your application.



OPERATING PRESSURE

The values given in the tabulation sections of this catalog indicate the most commonly used pressure ranges for the associated spray nozzle or accessory.

Contact your local **Spraying Systems Co. sales engineer** if your application requires pressure ranges beyond those stated in this catalog.

NOZZLE MATERIALS

For each nozzle there is a selection of “standard” materials that have been determined to meet the usual requirements of the applications most commonly associated with that type of nozzle. Standard materials include brass, steel, various stainless steels, hardened stainless steels, many plastics and various carbides. Spray nozzles can also be supplied in other materials upon special request including:

- AMPCO® 8
- CARPENTER® 20 (Alloy 20)
- Ceramics
- CUPRO® NICKEL
- Graphite
- HASTELLOY®
- INCONEL®
- MONEL®
- Nylon
- Polypropylene, PVC and CPVC
- REFRAx®
- Silicon carbide
- Stellite®
- Titanium
- Zirconium



NOZZLE WEAR

Nozzle wear is typically characterized by an increase in nozzle capacity, followed by a general deterioration of the spray pattern. Flat fan spray nozzles with elliptical orifices experience a narrowing of the spray pattern. In other spray pattern types, the distribution within the spray pattern deteriorates without substantially changing the coverage area. The increase in nozzle capacity can sometimes be recognized by a decrease in system operating pressure, particularly when using positive displacement pumps.

Materials having harder surfaces generally provide longer wear life. The chart below provides standard abrasion resistance ratios for different materials to help you determine if you should consider a different material for your nozzles, orifice inserts and/or spray tips.

Materials that offer better corrosion resistance are also available. However, the rate of chemical corrosion on specific nozzle materials is dependent on the solution being sprayed. The corrosive properties of the liquid being sprayed, its percent concentration and temperature, as well as the corrosion resistance of the nozzle material to the chemical must all be considered.

APPROXIMATE ABRASION RESISTANCE RATIOS

Spray Nozzle Material	Resistance Ratio
Aluminum	1
Brass	1
Polypropylene	1–2
Steel	1.5–2
MONEL	2–3
Stainless Steel	4–6
HASTELLOY	4–6
Hardened Stainless Steel	10–15
Stellite	10–15
Silicon Carbide (Nitride Bonded)	90–130
Ceramics	90–200
Carbides	180–250
Synthetic Ruby or Sapphire	600–2000

See Trademark Registration and Ownership, page i-1.

VISCOSITY

Absolute (dynamic) viscosity is the property of a liquid which resists change in the shape or arrangement of its elements during flow. Liquid viscosity is a primary factor affecting spray pattern formation and, to a lesser degree, capacity. High viscosity liquids – 100 cp or higher – require a higher minimum pressure to begin formation of a spray pattern and provide narrower spray angles as compared to those of water.

TEMPERATURE

The values given in this catalog are based on spraying water at 70°F (21°C). Although liquid temperature changes do not affect the spray performance of a nozzle, they often affect viscosity, surface tension and specific gravity which do influence spray nozzle performance.

SURFACE TENSION

The surface of a liquid tends to assume the smallest possible size; acting, in this respect, like a membrane under tension. Any portion of the liquid surface exerts a tension upon adjacent portions or upon other objects with which it is in contact. This force is in the plane of the surface and its amount per unit of length is surface tension. Its value for water is about 73 dynes per cm at 70°F (21°C). The main effects of surface tension are on minimum operating pressure, spray angle and drop size.

The property of surface tension is more apparent at low operating pressures. A higher surface tension reduces the spray angle, particularly on hollow cone and flat fan spray nozzles. Low surface tensions can allow a nozzle to be operated at a lower pressure.

SUMMARY OF SPRAY PERFORMANCE CONSIDERATIONS

The factors below can affect a spray nozzle’s performance, and the effects can vary based on nozzle type and size. In some applications, there are interrelated factors which may counteract certain effects. For instance, in the case of a hollow cone spray nozzle, increasing the temperature of the liquid decreases the specific gravity, thereby producing a greater flow rate while at the same time decreasing the viscosity which reduces the flow.

Nozzle Characteristics	Increase in Operating Pressure	Increase in Specific Gravity	Increase in Viscosity	Increase in Fluid Temperature	Increase in Surface Tension
Pattern Quality	Improves	Negligible	Deteriorates	Improves	Negligible
Drop Size	Decreases	Negligible	Increases	Decreases	Increases
Spray Angle	Increases then decreases	Negligible	Decreases	Increases	Decreases
Capacity	Increases	Decreases	Full/hollow cone – increases Flat – decreases	Depends on fluid sprayed and nozzle used	No effect
Impact	Increases	Negligible	Decreases	Increases	Negligible
Velocity	Increases	Decreases	Decreases	Increases	Negligible
Wear	Increases	Negligible	Decreases	Depends on fluid sprayed and nozzle used	No effect

ESTIMATING PRESSURE DROPS THROUGH FLUIDLINE ACCESSORIES

The rated capacities listed in this catalog for valves, strainers and fittings typically correspond to pressure drops of approximately 5% of their maximum operating pressure.

Visit spray.com/sprayware for an online pressure drop calculator. Or contact your local sales engineer.

APPROXIMATE FRICTION LOSS IN PIPE FITTINGS IN EQUIVALENT FEET (METERS) OF STRAIGHT PIPE

Use the chart below to determine the equivalent length of pipe through fittings to equate the friction loss.

Pipe Size Standard Wt. (in.)	Actual Inside Dia. in. (mm)	Gate Valve FULL OPEN ft. (m)	Globe Valve FULL OPEN ft. (m)	45° Elbow ft. (m)	Run of Standard Tee ft. (m)	Standard Elbow or Run of Tee Reduced 1/2 ft. (m)	Standard Tee Through Side Outlet ft. (m)
1/8	.269 (6.8)	.15 (.05)	8.0 (2.4)	.35 (.11)	.40 (.12)	.75 (.23)	1.4 (.43)
1/4	.364 (9.2)	.20 (.06)	11.0 (3.4)	.50 (.15)	.65 (.20)	1.1 (.34)	2.2 (.67)
1/2	.622 (15.8)	.35 (.11)	18.6 (5.7)	.78 (.24)	1.1 (.34)	1.7 (.52)	3.3 (1.0)
3/4	.824 (21)	.44 (.13)	23.1 (7.0)	.97 (.30)	1.4 (.43)	2.1 (.64)	4.2 (1.3)
1	1.049 (27)	.56 (.17)	29.4 (9.0)	1.2 (.37)	1.8 (.55)	2.6 (.79)	5.3 (1.6)
1-1/4	1.380 (35)	.74 (.23)	38.6 (11.8)	1.6 (.49)	2.3 (.70)	3.5 (1.1)	7.0 (2.1)
1-1/2	1.610 (41)	.86 (.26)	45.2 (13.8)	1.9 (.58)	2.7 (.82)	4.1 (1.2)	8.1 (2.5)
2	2.067 (53)	1.1 (.34)	58 (17.7)	2.4 (.73)	3.5 (1.1)	5.2 (1.6)	10.4 (3.2)
2-1/2	2.469 (63)	1.3 (.40)	69 (21)	2.9 (.88)	4.2 (1.3)	6.2 (1.9)	12.4 (3.8)
3	3.068 (78)	1.6 (.49)	86 (26)	3.6 (1.1)	5.2 (1.6)	7.7 (2.3)	15.5 (4.7)
4	4.026 (102)	2.1 (.64)	113 (34)	4.7 (1.4)	6.8 (2.1)	10.2 (3.1)	20.3 (6.2)
5	5.047 (128)	2.7 (.82)	142 (43)	5.9 (1.8)	8.5 (2.6)	12.7 (3.9)	25.4 (7.7)
6	6.065 (154)	3.2 (.98)	170 (52)	7.1 (2.2)	10.2 (3.1)	15.3 (4.7)	31 (9.4)

AIR FLOW (SCFM AND NLPM) THROUGH SCHEDULE 40 STEEL PIPE

Applied Pressure psig	Nominal Standard Pipe Size (scfm)											Applied Pressure bar	Nominal Standard Pipe Size (nlpm)										
	1/8"	1/4"	3/8"	1/2"	3/4"	1"	1-1/4"	1-1/2"	2"	2-1/2"	3"		1/8"	1/4"	3/8"	1/2"	3/4"	1"	1-1/4"	1-1/2"	2"	2-1/2"	3"
5	.5	1.2	2.7	4.9	6.6	13.0	27	40	80	135	240	0.3	14.2	34.0	76.5	139	187	370	765	1130	2265	3820	6796
10	.8	1.7	3.9	7.7	11.0	21	44	64	125	200	370	0.7	22.7	48.1	110	218	310	595	1245	1810	3540	5665	10480
20	1.3	3.0	6.6	13.0	18.5	35	75	110	215	350	600	1.4	36.8	85.0	187	370	525	990	2125	3115	6090	9910	16990
40	2.5	5.5	12.0	23	34	62	135	200	385	640	1100	2.8	70.8	155	340	650	960	1755	3820	5665	10900	18120	31150
60	3.5	8.0	18.0	34	50	93	195	290	560	900	1600	4.1	99.1	227	510	965	1415	2630	5520	8210	15860	25485	45305
80	4.7	10.5	23	44	65	120	255	380	720	1200	2100	5.5	133	297	650	1245	1840	3400	7220	10760	20390	33980	59465
100	5.8	13.0	29	54	80	150	315	470	900	1450	2600	6.9	164	370	820	1530	2265	4250	8920	13310	25485	41060	73625



FLOW OF WATER THROUGH SCHEDULE 40 STEEL PIPE – PRESSURE DROP

Flow gpm	Pressure Drop in psi for Various Pipe Diameters 10 ft. Length Pipe																Flow lpm	Pressure Drop in bar for Various Pipe Diameters 10 m Length Pipe																
	1/8"	1/4"	3/8"	1/2"	3/4"	1"	1 1/4"	1 1/2"	2"	2 1/2"	3"	3 1/2"	4"	5"	6"	8"		1/8"	1/4"	3/8"	1/2"	3/4"	1"	1 1/4"	1 1/2"	2"	2 1/2"	3"	3 1/2"	4"	5"	6"	8"	
.3	.42																1	.07																
.4	.70	.16															1.5	.16	.04															
.5	1.1	.24															2	.26	.06															
.6	1.5	.33															2.5	.40	.08															
.8	2.5	.54	.13														3	.56	.12	.03														
1.0	3.7	.83	.19	.06													4	.96	.21	.05	.02													
1.5	8.0	1.8	.40	.12													6	2.0	.45	.10	.03													
2.0	13.4	3.0	.66	.21	.05												8	3.5	.74	.17	.05	.01												
2.5		4.5	1.0	.32	.08												10		1.2	.25	.08	.02												
3.0		6.4	1.4	.43	.11												12		1.7	.35	.11	.03												
4.0		11.1	2.4	.74	.18	.06											15		2.6	.54	.17	.04	.01											
5.0			3.7	1.1	.28	.08											20			.92	.28	.07	.02											
6.0			5.2	1.6	.38	.12											25			1.2	.45	.11	.03											
8.0			9.1	2.8	.66	.20	.05										30			2.1	.62	.15	.04	.01										
10				4.2	1.0	.30	.08										40				1.1	.25	.08	.02										
15					2.2	.64	.16	.08									60				.54	.16	.04	.02	.006									
20					3.8	1.1	.28	.13	.04								80				.93	.28	.07	.03	.009									
25						1.7	.42	.19	.06								100					.43	.12	.05	.01									
30						2.4	.59	.27	.08								115					.58	.14	.06	.015									
35						3.2	.79	.36	.11	.04							130					.72	.18	.08	.02	.01								
40							1.0	.47	.14	.06							150						.23	.10	.03	.012								
45							1.3	.59	.17	.07							170						.29	.13	.04	.016								
50							1.6	.72	.20	.08							190						.36	.16	.05	.02								
60							2.2	1.0	.29	.12	.04						230						.50	.23	.07	.03	.009							
70								1.4	.38	.16	.05						260							.32	.09	.04	.01							
80								1.8	.50	.20	.07						300							.38	.11	.04	.02	.007						
90								2.2	.62	.25	.09	.04					340							.50	.14	.06	.02	.009						
100								2.7	.76	.31	.11	.05					380							.61	.18	.07	.03	.01						
125									1.2	.47	.16	.08	.04				470								.28	.11	.04	.02	.009					
150									1.7	.67	.22	.11	.06				570								.39	.15	.05	.03	.01					
200									2.9	1.2	.39	.19	.10				750								.64	.26	.09	.04	.02	.007				
250										.59	.28	.15	.05				950									.14	.06	.03	.01					
300											.84	.40	.21	.07			1150									.19	.09	.05	.02					
400												.70	.37	.12	.05		1500										.16	.08	.03	.01				
500													.57	.18	.07		1900											.13	.04	.02				
750														.39	.16	.04	2800												.09	.03	.009			
1000															.68	.27	.07	3800												.16	.06	.02		
2000																1.0	.26	7500													.23	.06		

Recommended capacity range for each size is shown in shaded areas.

For pipe lengths greater than 10 ft. (3 m), the pressure loss is proportional to the length. For 50 ft. (15 m) of pipe, the pressure drop is approximately 5 times the value in the table.



MAINTAINING SPRAY NOZZLES

Like any precision component, spray nozzles wear over time. Spray nozzle wear can be hard to detect. Small changes in performance can result in quality problems and wasted water, chemicals and electricity. The cost of using worn nozzles can be very significant – tens of thousands of dollars or more per year. Detecting nozzle wear in the early stages can prevent a significant profit drain.

USING NOZZLES THAT ARE SPRAYING JUST 15% OVER THE RATED CAPACITY*

	WASTE	COST OF EXCESS
WATER	1,701,835 gallons (6,442,146 liters)	US \$4,680
CHEMICALS	170,165 gallons (644,145 liters)	US \$170,164
WASTEWATER DISPOSAL	1,872,000 gallons (7,086,291 liters)	US \$7,956
TOTAL COST OF USING WORN NOZZLES:		US \$182,800

*Based on total system flow of 100 gpm (379 lpm). Water cost of US \$2.75/1000 gallons (3,785 liters). Chemical cost of US \$1.00 per gallon (liter) and a dilution ratio of 10:1. System operates 2080 hours per year. Increased electricity cost, scrap and downtime due to quality problems are not included.

DETECTING WORN SPRAY NOZZLES

Visually inspecting nozzles is a start but unless wear is significant, it may not be detectable.

The graphic below illustrates this problem. The spray tip on the left is new and sprays properly. The spray tip on the right is worn and sprays 30% over capacity. The difference is undetectable by inspecting the nozzle, but spray collection data reveals the difference between the two tips.

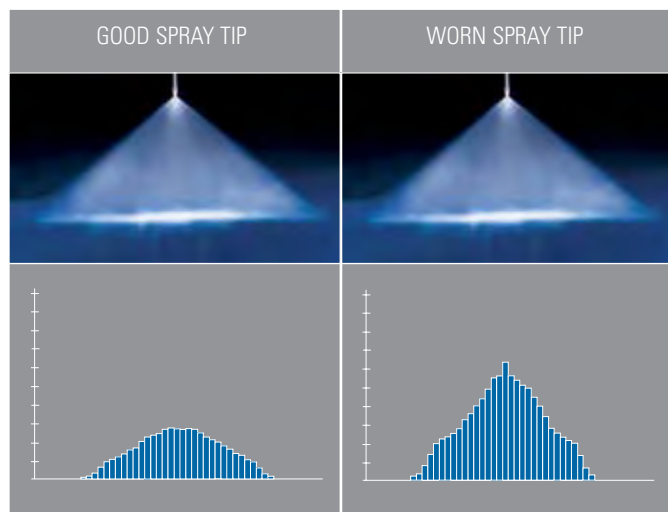

WATCH FOR THESE SIGNS OF NOZZLE WEAR:

- **Quality control issues and increased scrap.** Check for uneven coating, cooling, drying or cleaning and changes in temperature, dust content and humidity
- **Flow rate change:**
 - For centrifugal pumps: monitor flow meter readings to detect increases or collect and measure the flow from the spray nozzle for a given period of time at a specific pressure and compare them to flow rate readings from new, unused spray nozzles
 - For positive displacement pumps: monitor the liquid line pressure for decreases; the flow rate will remain constant
- **Spray pressure in the nozzle manifold:**
 - For centrifugal pumps: monitor for increases in liquid volume sprayed. The spraying pressure is likely to remain the same
 - For positive displacement pumps: monitor pressure gauge for decreases in pressure and reduction in impact on sprayed surfaces. The liquid volume sprayed is likely to remain the same. Also, monitor for increases in pressure due to clogged spray nozzles
- **Deterioration of spray pattern quality.** Visually inspect the spray pattern for changes. Check the spray angle with a protractor. Measure the width of the spray pattern on the sprayed surface

REPLACING WORN NOZZLES

Inspecting and maintaining your nozzles on a regular basis will help identify wear and extend service life. However, wear will occur over time and the only solution is to replace your nozzles. Here are a few guidelines to help you determine the optimal replacement interval:

- Are worn nozzles affecting product or process quality? If so, replace nozzles as soon as any wear is evident
- Is water conservation a priority? If so, replace nozzles as soon as wear is evident
- How much are you spending by continuing to use worn nozzles? How do the additional costs for water, chemicals, electricity and wastewater disposal compare with the cost of replacement nozzles?
- Is precise spray performance important to your overall process? If so, you may want to set pre-determined dates for nozzle replacement such as annual or semi-annual maintenance shutdowns

For more information on nozzle maintenance and replacement, visit spray.com. Or, contact your local sales engineer for assistance developing a nozzle maintenance program.



TABLE OF EQUIVALENTS

VOLUMETRIC UNIT

	Cubic Centimeter	Fluid Ounce	Pound of Water	Liter	US Gallon	Cubic Foot	Cubic Meter
Cubic Centimeter	•	.034	2.2×10^{-3}	.001	2.64×10^{-4}	3.53×10^{-5}	1.0×10^{-6}
Fluid Ounce	29.4	•	.065	.030	7.81×10^{-3}	1.04×10^{-3}	2.96×10^{-5}
Pound of Water	454	15.4	•	.454	.12	.016	4.54×10^{-4}
Liter	1000	33.8	2.2	•	.264	.035	.001
US Gallon	3785	128	8.34	3.785	•	.134	3.78×10^{-3}
Cubic Foot	28320	958	62.4	28.3	7.48	•	.028
Cubic Meter	1.0×10^6	3.38×10^4	2202	1000	264	35.3	•

LIQUID PRESSURE

	lb/in ² (psi)	Ft Water	Kg/Cm ²	Atmosphere	Bar	Inch Mercury	kPa (kilopascal)
lb/in ² (psi)	•	2.31	.070	.068	.069	2.04	6.895
Ft Water	.433	•	.030	.029	.030	.882	2.99
Kg/Cm ²	14.2	32.8	•	.968	.981	29.0	98
Atmosphere	14.7	33.9	1.03	•	1.01	29.9	101
Bar	14.5	33.5	1.02	.987	•	29.5	100
Inch Mercury	.491	1.13	.035	.033	.034	•	3.4
kPa (kilopascal)	.145	.335	.01	.009	.01	.296	•

LINEAR UNIT

	Micron	Mil	Millimeter	Centimeter	Inch	Foot	Meter
Micron	•	.039	.001	1.0×10^{-4}	3.94×10^{-5}	–	–
Mil	25.4	•	2.54×10^{-2}	2.54×10^{-3}	.001	8.33×10^{-5}	–
Millimeter	1000	39.4	•	.10	.0394	3.28×10^{-3}	.001
Centimeter	10000	394	10	•	.394	.033	.01
Inch	2.54×10^4	1000	25.4	2.54	•	.083	.0254
Foot	3.05×10^5	1.2×10^4	305	30.5	12	•	.305
Meter	1.0×10^6	3.94×10^4	1000	100	39.4	3.28	•

MISCELLANEOUS EQUIVALENTS

Unit	Equivalent
Ounce	28.35 g
Pound	.4536 kg
Horsepower	.746 kW
British Thermal Unit	.252 kcal
Square Inch	6.452 cm ²
Square Foot	.09290 m ²

MISCELLANEOUS FORMULAS

Unit	Formula
Fahrenheit (°F)	= $9/5$ (°C) + 32
Celsius (°C)	= $5/9$ (°F) – 32
Circumference of a Circle	= $3.1416 \times \text{Dia.}$
Area of a Circle	= $.7854 \times (\text{Dia.})^2$
Volume of a Sphere	= $.5236 \times (\text{Dia.})^3$
Area of a Sphere	= $3.1416 \times (\text{Dia.})^2$

DIMENSIONS

The catalog tabulations show orifice dimensions as “Nom.” (nominal).



READ THE FOLLOWING INSTRUCTIONS:



WARNING:

All safety related and operating instructions should be read before the nozzle is operated. Follow all operating instructions. Failure to do so could result in serious or fatal injury.



WARNING:

Spraying Systems Co. strongly recommends the use of appropriate safety equipment when working with potentially hazardous chemicals.

This equipment includes but is not limited to:

- Protective hat
- Safety glasses or face shield
- Chemical-resistant gloves and apron
- Long sleeve shirt and long pants



WARNING:

It is important to recognize proper safety precautions when using a pressurized spray system. Fluids under pressure can penetrate skin and cause severe injury. Seek medical attention immediately.



WARNING:

Before use, be sure appropriate connections are secure and made to withstand weight and reaction forces of the operating unit.

NOTE: Always remember to carefully read the chemical manufacturer's label and follow all directions.



WARNING:

When dealing with pressure applications, the system pressure should never exceed the lowest rated component. Always know your system and all component capabilities, maximum pressures and flow rates.



WARNING:

It is important to operate equipment within the temperature range of all components. Also, insure appropriate time lapse or proper safety equipment is used when handling components after they're exposed to high temperatures.



WARNING:

Before performing any maintenance, make sure all liquid supply lines to the machine are shut off and/or disconnected and chemicals/fluids are drained and not pressurized.



WARNING:

Do not use any equipment outside the intended purposes of the product. Misuse can result in personal injury or product damage.



WARNING:

The use of any chemicals requires careful control of all worker hygiene. Follow all MSDS or safety precautions provided by the manufacturer.



WARNING:

Spraying Systems Co. does not manufacture or supply any of the chemicals used with our nozzles and is not responsible for their effects. Because of the large number of chemicals that could be used and their different chemical reactions, the buyer and user of this equipment should determine compatibility of the materials used and any of the potential hazards involved.





FULL CONE NOZZLES

ABSORPTION · FIRE PROTECTION
CHEMICAL INJECTION · RINSING
FOAM CONTROL · CLEANING
GAS TREATMENT · DESUPERHEATING
MIST ELIMINATION · COOLING
DUST CONTROL



FULL CONE NOZZLES
INTRODUCTION



CHOOSE FROM THE INDUSTRY'S LARGEST SELECTION

Styles:

- Conventional
- Quick-connect
- Maximum free passage

Spray patterns:

- Standard
- Wide angle
- Narrow angle
- Square
- Wide angle square
- Oval

Spray angles: 15° to 170°

Flow rate range: .05 to 8728 gpm (.19 to 32530 lpm)

Operating pressure range: up to 400 psi (25 bar)

Connections:

- 1/8" to 12" pipe sizes
- Female and male NPT and BSPT
- Flange

Materials:

- Brass
- Mild steel
- 303 stainless steel
- 316 stainless steel
- Polyvinyl chloride
- Hardened stainless steel
- Kynar®
- Polypropylene
- ProMax®
- PTFE
- Other specialty materials available

See Trademark Registration and Ownership, page i-1.

OPTIMIZE THE PERFORMANCE OF FULLJET® NOZZLES:

Prevent debris from damaging and clogging nozzles, valves and pumps by using strainers. **T-style strainers** are available in a wide range of sizes, materials and pressure ratings.

See page F4



Precisely position spray nozzles to ensure proper coverage of target and minimize overspray with **adjustable ball fittings**. Leak-proof, clog-resistant fittings are available in several sizes and styles.

See page F23











Use **split-eyelet connectors** to simplify and facilitate installation of nozzles, gauges, hoses and other fittings. Economical connectors eliminate cutting, threading and brazing.

See page F23







**FULL CONE NOZZLES
TABLE OF CONTENTS**



FULLJET® G AND H NOZZLES:
STANDARD, WIDE AND NARROW ANGLE SPRAYS

	PAGE
 G and GG nozzles	B4
 GD and GGD wall-mount nozzles	B4
 GA and GGA angle-type nozzles	B4
 G-15 and GG-15 nozzles	B4
 G-30 and GG-30 nozzles	B4
 H, HH and D-HH nozzles	B5
 HF nozzles	B5
 HD wall-mount nozzles	B5
 H-15 and HH-30 nozzles	B5
 Quick Reference Guide	B6



QUICK FULLJET® AND PROMAX® QUICK FULLJET NOZZLES:
STANDARD, WIDE AND NARROW ANGLE SPRAYS

	PAGE
 QJA, QJLA, QJJA and QJJLA Quick FullJet bodies	B14
 QGA, QLGA, QHA and QLHA Quick FullJet spray tips	B14
 QPPA ProMax Quick FullJet body	B15
 QPHA ProMax Quick FullJet spray tips	B15
 Quick Reference Guide	B16



FULLJET® MAXIMUM FREE PASSAGE (MFP) NOZZLES:
STANDARD ANGLE SPRAY

	PAGE
 HMFP and HHMFP nozzles	B20
 Quick Reference Guide	B21





SPIRALJET® NOZZLES:
STANDARD ANGLE SPRAY AND EXTRA LARGE FREE
PASSAGE DESIGN

	PAGE
 HHSJ and HHSJX nozzles	B24
 Quick Reference Guide	B25



DISTRIBOJET® NOZZLES:
EXTRA LARGE FREE PASSAGE DESIGN

	PAGE
 R, RR and RF nozzles	B27
 Quick Reference Guide	B28

FULLJET® NOZZLES:
SQUARE AND OVAL SPRAY PATTERNS
AND VANELESS DESIGN

	PAGE
 G-SQ and GG-SQ nozzles	B30
 H-SQ, HH-SQ, H-WSQ and HH-WSQ nozzles	B30
 G-VL and GG-VL nozzles	B31
 GANV and GGANV nozzles	B31
 Quick Reference Guide	B32

UNIJET® NOZZLES:
STANDARD AND WIDE ANGLE SPRAYS
AND SQUARE SPRAY PATTERNS

	PAGE
 T and TT UniJet bodies	B36
 D, TG, TG-W, TH-W and TG-SQ UniJet spray tips	B36
 Quick Reference Guide	B37



FULL CONE

FULLJET® G AND H NOZZLES

S STANDARD ANGLE SPRAY | **W** WIDE ANGLE SPRAY | **N** NARROW ANGLE SPRAY

OVERVIEW: FULLJET G AND H

- Solid cone-shaped spray pattern with round impact area
- Unique vane design minimizes turbulence of the fluid to ensure uniform spray distribution and consistent spray coverage
- Large unobstructed flow passages minimize clogging and increase throughput
- Removable caps and vanes in most models make maintenance fast and easy
- Standard, wide and narrow spray angles

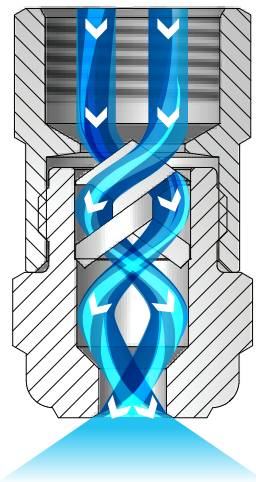

FullJet G and H Nozzles

The liquid enters the nozzle and proceeds through the vane. The vane causes the liquid to swirl. The design of the nozzle ensures the liquid continues to swirl as it enters the orifice. The liquid breaks up as it exits the nozzle orifice forming a well defined cone pattern. The drops are uniform in size and distributed equally throughout the spray pattern.

FULLJET G NOZZLES

- Spray angles: Standard – 43° to 94°, Narrow – 15° or 30°, Wide – 112° to 120°
- Uniform spray distribution from .07 to 25 gpm (.29 to 92 lpm)
- Operating pressures up to 300 psi (20 bar)
- Wall-mount versions for installation on room exterior, vessel or pipeline
- Right-angle mount versions for 90° angle mounting in areas with limited space



G
1/8" to 1/2" female conn.
Removable cap and vane



GG
1/8" to 1/2" male conn.
Removable cap and vane

FULLJET G OPTIONS

The image shows a wall-mount FullJet GD nozzle. It has a hexagonal base for wall mounting and a removable cap and vane. To the left of the nozzle are icons for spray types: 'S' (Standard), 'W' (Wide), and 'N' (Narrow), with a green drop for 'S' and a red drop for 'W'.

GD – 1/8" to 1/2" female conn.
Wall-mount
Removable cap and vane

The image shows a wall-mount FullJet GGD nozzle. It has a threaded male base for wall mounting and a removable cap and vane. To the left of the nozzle are icons for spray types: 'S' (Standard), 'W' (Wide), and 'N' (Narrow), with a green drop for 'S' and a red drop for 'W'.

GGD – 1/8" to 1/2" male conn.
Wall-mount
Removable cap and vane

The image shows an angle-type FullJet GA nozzle. It has a 90-degree angled base and a removable cap and vane. To the left of the nozzle are icons for spray types: 'S' (Standard), 'W' (Wide), and 'N' (Narrow), with a green drop for 'S' and a red drop for 'W'.

GA – 1/8" to 1/2" female conn.
Angle-type
Removable cap and vane

The image shows an angle-type FullJet GGA nozzle. It has a 90-degree angled threaded male base and a removable cap and vane. To the left of the nozzle are icons for spray types: 'S' (Standard), 'W' (Wide), and 'N' (Narrow), with a green drop for 'S' and a red drop for 'W'.

GGA – 1/8" to 1/2" male conn.
Angle-type
Removable cap and vane

The image shows a narrow angle FullJet G-15 nozzle. It has a hexagonal base and a removable cap and vane. To the left of the nozzle is an icon for spray type: 'N' (Narrow), with a red drop.

G-15
1/8" to 1/2" female conn.
Removable cap and vane

The image shows a narrow angle FullJet GG-15 nozzle. It has a threaded male base and a removable cap and vane. To the left of the nozzle is an icon for spray type: 'N' (Narrow), with a red drop.

GG-15
1/8" to 1/2" male conn.
Removable cap and vane

The image shows a wide angle FullJet G-30 nozzle. It has a hexagonal base and a removable cap and vane. To the left of the nozzle is an icon for spray type: 'N' (Narrow), with a red drop.

G-30
1/8" to 3/4" female conn.
Removable cap and vane

The image shows a wide angle FullJet GG-30 nozzle. It has a threaded male base and a removable cap and vane. To the left of the nozzle is an icon for spray type: 'N' (Narrow), with a red drop.

GG-30
1/8" to 3/4" male conn.
Removable cap and vane

FULLJET® G AND H NOZZLES

**FULL
CONE**

S STANDARD ANGLE SPRAY | **W** WIDE ANGLE SPRAY | **N** NARROW ANGLE SPRAY

FULLJET H NOZZLES

- Spray angles: Standard – 43° to 94°, Narrow – 15° or 30°, Wide – 102° to 125°
- Uniform spray distribution from .07 to 5324 gpm (.29 to 19842 lpm)
- Operating pressures up to 300 psi (20 bar)
- Wall-mount versions for installation on room exterior, vessel or pipeline
- Certain nozzles available with UL listing 



H – 3/4" to 1" female conn. One-piece body
H – 1-1/4" to 8" female conn. Removable vane/cast body
H – 1-1/2" to 2" female conn. Removable vane/polypropylene*

FULLJET H OPTIONS

 <p>HH – 1/8" to 1" male conn. One-piece body</p>	 <p>D-HH – 1/2" to 3/4" male conn. One-piece body/plastic**</p>	 <p>HF – 4" to 10" flange conn. Removable vane/cast body</p>	
 <p>HD – 3/4" to 3" female conn. Wall-mount One-piece body</p>	 <p>H-15 – 3/4" to 3" female conn. One-piece body Removable vane</p>	 <p>H-15 – 4" to 5" female conn. Two-piece cast body Removable vane</p>	 <p>HH-30 – 1" to 2-1/2" male conn. One-piece body Removable vane</p>

*Max. temperature for polypropylene: 150°F (66°C). ** Max. temperature for Kynar®: 212°F (100°C).

ORDERING INFORMATION

FULLJET G, GD, GA, G-15, G-30, H, HF, HD, H-15 AND HH-30

Inlet Conn.	Nozzle Type	–	Material Code	Capacity Size	Example
					1/4 G – SS 10

BSPT connections require the addition of a "B" prior to the inlet connection.

FULLJET D-HH

Nozzle Prefix	Inlet Conn.	Nozzle Type	–	Material Code	Spray Angle	Capacity Size	Example
							D 1/2 HH – PP 70 24

BSPT connections require the addition of a "B" prior to the inlet connection.

**RELATIVE DROP SIZE
IN MICRONS**

 10 to 100	 100 to 500	 500 to 1000	 1000 to 5000
---	--	---	--

Drop size will vary based on flow rate and pressure.

QUICK REFERENCE GUIDE

Model	Connection/ Type	Connection Size (in.)	Materials	Page Number	
				Performance Data	Dimensions and Weights
G	F	1/8 to 1/2	Brass, Mild steel (I), 303 stainless steel (SS), 316 stainless steel (316SS), Polyvinyl chloride (PVC)	B7	B12
GG	M	1/8 to 1/2			
GD	F, Wall-mount	1/8 to 1/2			
GGD	M, Wall-mount	1/8 to 1/2			
GA	F, Angle-type	1/8 to 1/2			
GGA	M, Angle-type	1/8 to 1/2			
G-W	F	1/8 to 1/2	Brass, Mild steel (I), 303 stainless steel (SS), 316 stainless steel (316SS), Polyvinyl chloride (PVC)	B10	
GG-W	M	1/8 to 1/2			
GA-W	F, Angle-type	1/8 to 1/2			
GGA-W	M, Angle-type	1/8 to 1/2			
G-15	F	1/8 to 1/2	Brass, 303 stainless steel (SS)	B11	
GG-15	M	1/8 to 1/2			
G-30	F	1/8 to 3/4	Brass, 303 stainless steel (SS), 316 stainless steel/303 caps (SS)	B11	
GG-30	M	1/8 to 3/4			
H	F	3/4 to 1	Brass, Mild steel (I), 303 stainless steel (SS), 316 stainless steel (316SS), Polyvinyl chloride (PVC)	B7	
H	F, Cast	1-1/4 to 8	Brass, 316 stainless steel (SS)	B7–B9	
H	F	1-1/2 to 2	Polypropylene (PP)	B8	
HH	M	1/8 to 1	Brass, Mild steel (I), 303 stainless steel (SS), 316 stainless steel (316SS), Polyvinyl chloride (PVC)	B7	
D-HH	M	1/2 to 3/4	Kynar®, Polypropylene (PP)	B9	
HF	Flange, Cast	4 to 10	Brass, 316 stainless steel (SS)	B8, B9	
HD	F, Wall-mount	3/4 to 3	Brass, Mild steel (I), 303 stainless steel (SS)	B7, B8	
H-W	F	3/4 to 1	Brass, Mild steel (I), 303 stainless steel (SS), 316 stainless steel (316SS)	B10	
H-W	F, Cast	1-1/4 to 4	Brass, 316 stainless steel (SS)		
H-W	F	1-1/2 to 2	Polypropylene (PP)		
HH-W	M	1/8 to 1-1/2	Brass, Mild steel (I), 303 stainless steel (SS), 316 stainless steel (316SS), Polyvinyl chloride (PVC)	B11	
H-15	F	3/4 to 3	Brass, 303 stainless steel (SS)		
H-15	F, Cast	4 to 5	Brass, 316 stainless steel/303 caps (SS)		
HH-30	M	1 to 2-1/2	Brass, 303 stainless steel (SS), 316 stainless steel/303 caps (SS)		

F = female thread; M = male thread. There is no material code for brass. Leave material code blank when ordering. Other materials available upon request. For more dimensions and sizes, contact your sales engineer.



S PERFORMANCE DATA:
STANDARD ANGLE SPRAY



Inlet Conn. (in.)	Nozzle Type										Capacity Size	Orifice Dia. Nom. (in.)	Max. Free Passage Dia. (in.)	Flow Rate Capacity (gallons per minute)										Spray Angle (°)		
	Standard				Wall-Mount			Angle						5 psi	7 psi	10 psi	20 psi	40 psi	80 psi	100 psi	150 psi	7 psi	20 psi	80 psi		
	G	GG	H	HH	HF	GD	HD	GGD	GA	GGA																
1/8	•	•		•		•		•			1	.031	.025	–	–	.10	.14	.19	.26	.29	.35	–	58	53		
	•	•		•							1.5	.044	.025	.11	.13	.15	.21	.28	.39	.43	.52	52	65	59		
	•	•		•		•		•	•	•	2	.048	.040	.15	.17	.20	.28	.38	.52	.58	.70	43	50	46		
	•	•		•		•		•	•	•	3	.063	.040	.22	.25	.30	.41	.57	.78	.87	1.0	52	65	59		
	•	•		•		•		•	•	•	3.5	.063	.050	.25	.30	.35	.48	.66	.91	1.0	1.2	43	50	46		
									•	•	3.9	.078	.040	.28	.33	.39	.54	.74	1.0	1.1	1.4	77	84	79		
	•	•		•		•		•	•	•	5	.078	.050	.36	.42	.50	.69	.95	1.3	1.4	1.7	52	65	59		
1/4								•	•	6.1	.094	.050	.44	.52	.61	.84	1.2	1.6	1.8	2.1	69	74	68			
	•	•		•		•		•	•	6.5	.094	.063	.47	.55	.65	.89	1.2	1.7	1.9	2.3	45	50	46			
	•	•		•		•		•	•	10	.109	.063	.73	.85	1.0	1.4	1.9	2.6	2.9	3.5	58	67	61			
3/8								•	•	12.5	.125	.063	.91	1.1	1.3	1.7	2.4	3.3	3.6	4.3	69	74	68			
	•	•		•		•		•	•	9.5	.109	.094	.69	.81	.95	1.3	1.8	2.5	2.7	3.3	45	50	46			
	•	•		•		•		•	•	15	.141	.094	1.1	1.3	1.5	2.1	2.8	3.9	4.3	5.2	64	67	61			
									•	•	20	.156	.109	1.5	1.7	2.0	2.8	3.8	5.2	5.8	7.0	76	80	73		
1/2	•	•		•		•		•	•	22	.188	.109	1.6	1.9	2.2	3.0	4.2	5.7	6.3	7.6	87	90	82			
	•	•		•		•		•	•	16	.141	.125	1.2	1.4	1.6	2.2	3.0	4.2	4.6	5.6	48	50	46			
	•	•		•		•		•	•	25	.188	.125	1.8	2.1	2.5	3.4	4.7	6.5	7.2	8.7	64	67	61			
	•	•		•		•		•	•	32	.203	.141	2.3	2.7	3.2	4.4	6.1	8.3	9.2	11.1	72	75	68			
	•	•		•		•		•	•	40	.250	.141	2.9	3.4	4.0	5.5	7.6	10.4	11.5	13.9	88	91	83			
3/4								•	•	50	.266	.156	3.6	4.2	5.0	6.9	9.5	13.0	14.4	17.4	91	94	86			
			•	•		•				2.5	.188	.172	2.1	2.5	2.9	4.1	5.6	7.7	8.5	10.2	48	50	46			
			•	•		•				4.0	.250	.172	3.4	4.0	4.7	6.5	8.9	12.3	13.6	16.4	67	70	63			
1			•	•		•				7.0	.328	.203	6.0	7.0	8.2	11.3	15.6	21	24	29	89	92	84			
			•	•		•				4.2	.234	.219	3.6	4.2	4.9	6.8	9.4	12.9	14.3	17.2	48	50	46			
			•	•		•				7.0	.328	.219	6.0	7.0	8.2	11.3	15.6	21	24	29	67	68	62			
			•	•		•				8.0	.375	.219	6.9	8.0	9.4	13.0	17.8	25	27	33	72	81	82			
			•	•		•				10	.469	.219	8.6	10.0	11.8	16.2	22	31	34	41	78	90	94			
			•	•		•				12	.469	.250	10.3	12.0	14.1	19.4	27	37	41	49	89	92	84			
1-1/4			•			•				6	.297	.250	5.1	6.0	7.1	9.7	13.4	18.4	20	25	48	50	44			
			•			•				10	.375	.250	8.6	10.0	11.8	16.2	22	31	34	41	64	67	58			
			•			•				12	.422	.250	10.3	12.0	14.1	19.4	27	37	41	49	66	70	60			
			•			•				14	.484	.250	12.0	14.0	16.5	23	31	43	48	57	77	80	70			
			•			•				16	.500	.313	13.7	16.0	18.9	26	36	49	54	66	73	76	66			
		•			•				20	.594	.313	17.1	20	24	32	45	61	68	82	90	93	81				

Maximum Free Passage Diameter is the maximum diameter as listed of foreign matter that can pass through the nozzle without clogging.

Highlighted column shows the rated pressure.



S PERFORMANCE DATA:
STANDARD ANGLE SPRAY

Inlet Conn. (in.)	Nozzle Type										Capacity Size	Orifice Dia. Nom. (in.)	Max. Free Passage Dia. (in.)	Flow Rate Capacity (gallons per minute)								Spray Angle (°)		
	Standard					Wall-Mount			Angle					5 psi	7 psi	10 psi	20 psi	40 psi	80 psi	100 psi	150 psi	7 psi	20 psi	80 psi
	G	GG	H	HH	HF	GD	HD	GGD	GA	GGA														
1-1/2			•				•				10	.375	.344	8.6	10.0	11.8	16.2	22	31	34	41	48	50	44
			•				•				16	.500	.344	13.7	16.0	18.9	26	36	49	54	66	72	74	64
			•				•				20	.563	.344	17.1	20	24	32	45	61	68	82	74	76	66
			•				•				30*	.719	.406	26	30	35	49	67	92	102	123	91	94	82
2			•				•				17	.500	.438	14.6	17.0	20	28	38	52	58	70	49	50	44
			•				•				30	.688	.438	26	30	35	49	67	92	102	123	72	74	64
			•				•				35	.750	.438	30	35	41	57	78	107	119	143	75	77	68
			•				•				40	.828	.438	34	40	47	65	89	123	136	164	78	80	70
			•				•				50*	.938	.563	43	50	59	81	111	153	170	205	83	85	75
			•				•				60*	1.125	.563	51	60	71	97	134	184	204	246	98	100	86
2-1/2			•				•				25	.594	.563	21	25	29	41	56	77	85	102	49	50	44
			•				•				50	.875	.563	43	50	59	81	111	153	170	205	72	74	64
			•				•				60	.969	.563	51	60	71	97	134	184	204	246	76	78	68
			•				•				70	1.125	.563	60	70	82	113	156	215	238	287	79	82	72
			•				•				80	1.125	.688	69	80	94	130	178	245	272	328	86	88	77
			•				•				90	1.250	.688	77	90	106	146	201	276	306	369	95	97	84
3			•				•				42	.750	.688	36	42	49	68	94	129	143	172	49	50	44
			•				•				80	1.094	.688	69	80	94	130	178	245	272	328	81	84	73
			•				•				90	1.188	.688	77	90	106	146	201	276	306	369	86	89	77
			•				•				100	1.281	.688	86	100	118	162	223	307	340	410	92	95	83
			•				•				110	1.938	.813	93	110	131	186	263	372	416	509	86	89	77
			•				•				120	1.375	.813	101	120	143	203	287	406	454	555	102	105	89
4			•		•						160	1.688	.750	137	160	189	259	357	491	544	655	87	90	70
			•		•						180	1.859	.875	154	180	212	292	401	552	612	737	92	95	83
			•		•						200	2.0	1.0	171	200	236	324	446	613	680	819	97	100	87
			•		•						210	2.156	1.0	180	210	247	340	468	644	714	860	102	105	91
5			•		•						250	1.875	1.125	214	250	295	405	557	767	850	1024	89	91	80
			•		•						280	2.078	1.125	240	280	330	454	624	859	952	1147	93	96	84
			•		•						320	2.688	1.375	274	320	377	519	713	981	1087	1310	97	100	87
			•		•						330	2.844	1.375	283	330	389	535	736	1012	1121	1351	102	105	91
6			•		•						350	2.406	1.625	300	350	412	567	780	1073	1189	1433	87	90	78
			•		•						400	2.719	1.625	343	400	471	648	892	1227	1359	1638	92	95	83
			•		•						450	3.031	1.750	385	450	530	729	1003	1380	1529	1843	97	100	87
			•		•						480	3.219	1.750	411	480	566	778	1070	1472	1631	1966	102	105	91

Maximum Free Passage Diameter is the maximum diameter as listed of foreign matter that can pass through the nozzle without clogging.

*These capacity sizes are not available for H in polypropylene.

Highlighted column shows the rated pressure.



S PERFORMANCE DATA: STANDARD ANGLE SPRAY

Inlet Conn. (in.)	Nozzle Type										Capacity Size	Orifice Dia. Nom. (in.)	Max. Free Passage Dia. (in.)	Flow Rate Capacity (gallons per minute)								Spray Angle (°)		
	Standard					Wall-Mount			Angle					5 psi	7 psi	10 psi	20 psi	40 psi	80 psi	100 psi	150 psi	7 psi	20 psi	80 psi
	G	GG	H	HH	HF	GD	HD	GGD	GA	GGA														
8			●		●						500	2.750	1.875	428	500	589	810	1115	1533	1699	2048	78	80	70
			●		●						600	3.156	1.875	514	600	707	972	1338	1840	2039	2457	86	88	77
			●		●						700	3.594	1.875	600	700	825	1135	1561	2147	2379	2867	92	95	83
			●		●						800	4.031	2.250	685	800	943	1297	1784	2453	2719	3276	102	105	91
			●		●						900	4.875	2.250	771	900	1060	1459	2007	2760	3058	3686	106	110	96
10					●						800	3.344	2.500	685	800	943	1297	1784	2453	2719	3276	78	80	70
					●						1000	3.969	2.500	857	1000	1178	1621	2229	3067	3398	4095	86	89	77
					●						1200	4.797	2.625	1028	1200	1414	1945	2675	3680	4078	4914	97	100	87
					●						1300	5.313	2.625	1114	1300	1532	2107	2898	3987	4418	5324	103	106	92

Maximum Free Passage Diameter is the maximum diameter as listed of foreign matter that can pass through the nozzle without clogging.

Highlighted column shows the rated pressure.

S PERFORMANCE DATA: STANDARD ANGLE SPRAY

Inlet Conn. (in.)	Nozzle Type			Capacity Size	Max. Free Passage Dia. (in.)	Flow Rate Capacity (gallons per minute)									
	D-HH					5 psi	7 psi	10 psi	20 psi	30 psi	40 psi	60 psi	80 psi	100 psi	150 psi
	Spray Angle														
	70°	90°	120°												
1/2	●	●		24	0.161	1.7	2.0	2.4	3.3	4.0	4.6	5.5	6.3	6.9	8.3
		●		26	0.161	1.9	2.2	2.6	3.6	4.3	5.0	5.9	6.8	7.5	9.0
	●	●		27.5	0.162	2.0	2.3	2.8	3.8	4.6	5.3	6.3	7.2	7.9	9.6
	●	●	●	31	0.118	2.3	2.6	3.1	4.3	5.1	5.9	7.1	8.1	8.9	10.8
		●	●	40	0.138	2.9	3.4	4.0	5.5	6.6	7.7	9.1	10.4	11.5	13.9
		●	●	50	0.165	3.6	4.2	5.0	6.9	8.3	9.6	11.4	13.0	14.4	17.4
		●	●	58	0.197	4.2	4.9	5.8	8.0	9.6	11.1	13.2	15.1	16.7	20.2
3/4		●		3.4	0.197	2.9	3.4	4.0	5.5	6.7	7.7	9.1	10.4	11.5	13.9
		●		4.1	0.197	3.5	4.1	4.8	6.6	8.1	9.2	11.0	12.6	13.8	16.7
		●		4.8	0.197	4.1	4.8	5.6	7.7	9.4	10.7	12.9	14.7	16.2	19.5
		●	●	6	0.221	5.2	6.0	7.1	9.8	11.7	13.6	16.1	18.4	20.5	24.7
		●	●	7	0.221	6.0	7.0	8.3	11.4	13.7	15.9	18.8	21.5	23.9	28.9
		●	●	8.5	0.228	7.3	8.5	10.0	13.8	16.6	19.2	22.8	26.0	28.8	34.8
			●	10	0.228	8.6	10.0	11.8	16.2	19.5	22.3	26.9	30.7	34.0	41.0

Maximum Free Passage Diameter is the maximum diameter as listed of foreign matter that can pass through the nozzle without clogging.

Highlighted column shows the rated pressure.



FULL
CONE

FULLJET® G AND H NOZZLES

W WIDE ANGLE SPRAY

W PERFORMANCE DATA:
WIDE ANGLE SPRAY



Inlet Conn. (in.)	Nozzle Type						Capacity Size	Orifice Dia. Nom. (in.)	Max. Free Passage Dia. (in.)	Flow Rate Capacity (gallons per minute)							Spray Angle (°)		
	Standard				Angle					5 psi	7 psi	10 psi	15 psi	20 psi	40 psi	80 psi	5 psi	10 psi	80 psi
	G-W	GG-W	HH-W	H-W	GA-W	GGA-W													
1/8	•	•					1.5W	.047	.025	-	-	.15	.18	.21	.28	.39	-	120	86
	•	•	•				2.8W	.063	.040	-	-	.28	.34	.39	.53	.73	-	120	102
	•	•	•		•	•	4.3W	.078	.040	-	-	.43	.52	.59	.81	1.1	-	120	102
	•	•					5.6W	.094	.040	-	.48	.56	.67	.77	1.1	1.5	-	120	102
	•	•	•		•	•	8W	.094	.050	-	.68	.80	.96	1.1	1.5	2.1	-	120	103
1/4	•	•					10W	.109	.050	.73	.85	1.0	1.2	1.4	1.9	2.6	112	120	103
	•	•					12W	.125	.050	.87	1.0	1.2	1.4	1.7	2.3	3.1	114	120	103
	•	•	•		•	•	14W	.141	.063	1.0	1.2	1.4	1.7	1.9	2.6	3.6	114	120	103
3/8	•	•	•				17W	.156	.063	1.2	1.4	1.7	2.0	2.3	3.2	4.4	114	120	103
	•	•	•		•	•	20W	.172	.094	1.5	1.7	2.0	2.4	2.8	3.8	5.2	114	120	104
	•	•	•				24W	.188	.094	1.7	2.0	2.4	2.9	3.3	4.5	6.2	114	120	104
	•	•	•				27W	.203	.109	2.0	2.3	2.7	3.3	3.7	5.1	7.0	114	120	106
1/2	•	•	•				30W	.219	.109	2.2	2.5	3.0	3.6	4.1	5.7	7.8	114	120	108
	•	•	•		•	•	35W	.234	.125	2.5	3.0	3.5	4.2	4.8	6.6	9.1	114	120	108
	•	•	•				40W	.250	.125	2.9	3.4	4.0	4.8	5.5	7.6	10.4	114	120	108
	•	•	•				45W	.250	.141	3.3	3.8	4.5	5.4	6.2	8.5	11.7	114	120	110
	•	•	•		•	•	50W	.266	.156	3.6	4.2	5.0	6.0	6.9	9.5	13.0	114	120	112
3/4			•	•			6W	.391	.172	5.2	6.0	7.0	8.4	9.5	12.9	17.5	115	120	112
1			•	•			11W	.516	.219	9.5	11.0	12.9	15.4	17.5	24	32	117	120	117
1-1/4			•	•			16W	.609	.250	13.8	16.0	18.7	22	25	34	47	118	121	119
1-1/2			•	•			24W	.719	.406	21	24	28	34	38	52	70	119	124	119
2				•			47W	.984	.438	41	47	55	66	75	101	137	120	124	119
2-1/2				•			70W	1.3	.563	60	70	82	98	111	151	204	120	125	119
3				•			95W	1.4	.688	82	95	111	133	151	205	277	120	125	119
4				•			188W	2.0	.813	162	188	220	263	298	405	549	120	125	119

Maximum Free Passage Diameter is the maximum diameter as listed of foreign matter that can pass through the nozzle without clogging.

Highlighted column shows the rated pressure.



N PERFORMANCE DATA:
NARROW ANGLE SPRAY



Inlet Conn. (in.)	Nozzle Type						Capacity Size	Orifice Dia. Nom. (in.)	Flow Rate Capacity (gallons per minute)										Spray Angle (°)			
	G-15	G-30	GG-15	GG-30	H-15	HH-30			10 psi	15 psi	20 psi	40 psi	80 psi	100 psi	150 psi	200 psi	300 psi	10 psi	15 psi	40 psi	100 psi	
1/8	•		•				1507	.063	.35	.43	.49	.70	.99	1.1	1.4	1.6	1.9	13	14	15	15	
	•		•				1514	.094	.70	.86	.99	1.4	2.0	2.2	2.7	3.1	3.8	13	14	15	15	
1/4	•		•				1530	.125	1.5	1.8	2.1	3.0	4.2	4.7	5.8	6.7	8.2	13	14	15	15	
3/8	•		•				1550	.172	2.5	3.1	3.5	5.0	7.1	7.9	9.7	11.2	13.7	13	14	15	15	
1/2	•		•				1590	.219	4.5	5.5	6.4	9.0	12.7	14.2	17.4	20	25	13	14	15	15	
3/4					•		15150	.297	7.5	9.2	10.6	15.0	21	24	29	34	41	13	14	15	15	
1					•		15280	.391	14.0	17.1	19.8	28	40	44	54	63	77	13	14	15	15	
1-1/4					•		15430	.484	22	26	30	43	61	68	83	96	118	14	14	15	15	
1-1/2					•		15630	.594	32	39	45	63	89	100	122	141	173	14	14	15	15	
2					•		151150	.797	58	70	81	115	163	182	223	257	315	14	14	15	15	
2-1/2					•		151750	.969	88	107	124	175	247	277	339	391	479	14	14	15	15	
3					•		152500	1.156	125	153	177	250	354	395	484	559	685	14	14	15	15	
4					•		154500	1.141	225	276	318	450	636	712	871	1006	1232	14	14	15	15	
5					•		157000	1.922	350	429	495	700	990	1107	1356	1565	1917	14	14	15	15	
1/8		•		•			3001.4	.031	.070	.086	.099	.14	.20	.22	.27	.31	.38	11	17	30	31	
		•		•			3002.5	.031	.13	.15	.18	.25	.35	.40	.48	.56	.68	12	17	30	32	
		•		•			3004	.047	.20	.24	.28	.40	.57	.63	.77	.89	1.1	20	26	30	32	
		•		•			3007	.063	.35	.43	.49	.70	.99	1.1	1.4	1.6	1.9	20	23	30	30	
1/4		•		•		3009	.078	.45	.55	.64	.90	1.3	1.4	1.7	2.0	2.5	20	23	30	30		
3/8		•		•		3014	.094	.70	.86	.99	1.4	2.0	2.2	2.7	3.1	3.8	20	25	30	30		
1/2		•		•		3030	.125	1.5	1.8	2.1	3.0	4.2	4.7	5.8	6.7	8.2	21	26	30	31		
3/4		•		•		3050	.172	2.5	3.1	3.5	5.0	7.1	7.9	9.7	11.2	13.7	22	26	30	31		
1						•	3070	.203	3.5	4.3	4.9	7.0	9.9	11.1	13.6	15.7	19.2	22	27	30	30	
						•	30100	.250	5.0	6.1	7.1	10.0	14.1	15.8	19.4	22	27	22	27	30	30	
1-1/4						•	30150	.297	7.5	9.2	10.6	15.0	21	24	29	34	41	22	27	30	30	
						•	30200	.344	10.0	12.2	14.1	20	28	32	39	45	55	22	27	30	30	
1-1/2						•	30250	.375	12.5	15.3	17.7	25	35	40	48	56	68	22	27	30	30	
						•	30300	.406	15.0	18.4	21	30	42	47	58	67	82	22	27	30	30	
2						•	30350	.438	17.5	21	25	35	49	55	68	78	96	22	28	30	30	
						•	30400	.469	20	24	28	40	57	63	77	89	110	22	28	30	30	
						•	30500	.531	25	31	35	50	71	79	97	112	137	22	28	30	30	
2-1/2						•	30600	.578	30	37	42	60	85	95	116	134	164	22	28	30	30	
						•	30700	.625	35	43	49	70	99	111	136	157	192	22	28	30	30	
						•	301000	.750	50	61	71	100	141	158	194	224	274	22	28	30	30	
						•	301100	.781	55	67	78	110	156	174	213	246	301	22	28	30	30	
					•	301200	.813	60	73	85	120	170	190	232	268	329	22	28	30	30		

Highlighted column shows the rated pressure.

DIMENSIONS AND WEIGHTS

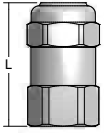
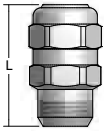
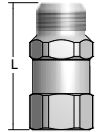
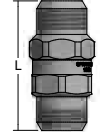
Nozzle	Nozzle Type	Inlet Conn. (in.)	L (in.)	Hex. (in.)	Net Weight (oz.)
	G (F) G-W (F)	1/8	1.219	9/16	1
		1/4	1.469	11/16	1.5
		3/8	1.812	13/16	2.5
		1/2	2.250	1	6
	GG (M) GG-W (M)	1/8	1.281	9/16	0.8
		1/4	1.563	11/16	1.5
		3/8	1.844	13/16	2.5
		1/2	2.219	1	6
	GD (F)	1/8	1.391	9/16	1
		1/4	1.609	11/16	1.5
		3/8	1.813	1	2.5
		1/2	1.203	1	4.8
	GGD (M)	1/8	1.453	9/16	1
		1/4	1.703	11/16	1.5
		3/8	1.844	13/16	2.5
		1/2	2.172	1	4.5

Based on the largest/heaviest version of each type.

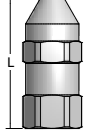
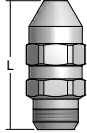
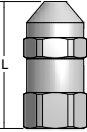
Nozzle	Nozzle Type	Inlet Conn. (in.)	L (in.)	Hex. (in.)	Net Weight (oz.)
	G-15 (F)	1/8	1.313	9/16	1
		1/4	1.625	11/16	2
		3/8	1.875	13/16	3
		1/2	2.406	1	6
	GG-15 (M)	1/8	1.375	9/16	1
		1/4	1.719	11/16	1.3
		3/8	1.906	13/16	3.3
		1/2	2.406	1	6
	G-30 (F)	1/8	1.390	11/16	2.3
		1/4	1.688	13/16	3.3
		3/8	2.125	1	6
		1/2	2.343	1-1/4	11.3
		3/4	3.313	1-1/2	15
	GG-30 (M)	1/8	1.531	23/32	2
		1/4	1.781	13/16	3
		3/8	2.188	13/16	5.5
		1/2	2.750	1-1/4	9
		3/4	3.438	1-1/2	20

Based on the largest/heaviest version of each type.

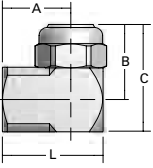
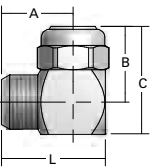
Nozzle	Nozzle Type	Inlet Conn. (in.)	L (in.)	A (in.)	B (in.)	C (in.)	Net Weight (oz.)
	GA (F) GA-W (F)	1/8	0.910	0.630	0.563	0.844	1.5
		1/4	1.130	0.790	0.781	1.125	2
		3/8	1.281	0.875	1.188	1.594	3.3
		1/2	1.563	1.063	1.359	1.859	6.3
	GGA (M) GGA-W (M)	1/8	0.940	0.660	0.563	0.844	1.5
		1/4	1.160	0.820	0.781	1.125	2
		3/8	1.313	0.906	1.188	1.594	3.3
		1/2	1.609	1.109	1.359	1.859	6.3

Based on the largest/heaviest version of each type.

S STANDARD ANGLE SPRAY

W WIDE ANGLE SPRAY

N NARROW ANGLE SPRAY

**FULL
CONE**

FULLJET® G AND H NOZZLES

DIMENSIONS AND WEIGHTS

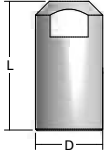
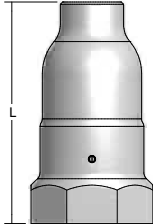
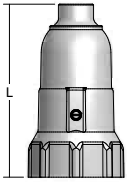
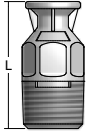
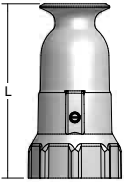
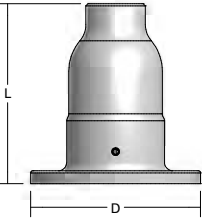
Nozzle	Nozzle Type	Inlet Conn. (in.)	L (in.)	D (Dia.) (in.)	Net Weight (oz.)	
	H (F) H-W (F)	3/4	2.188	1.250	7.3	
		1	2.734	1.500	12.4	
	H (F) H-W (F) Cast	1-1/4	3.440	2.063 oct.	25.7	
		1-1/2	4.063	2.313 oct.	25.4	
		2	5.440	3.000 oct.	60	
		2-1/2	6.313	3.438 oct.	76	
		3	7.375	4.063 oct.	95.3	
		4	9.563	5.438 oct.	12 lbs.	
		H (F) Cast <small>(Standard angle only) Wide angle not available in Cast for these sizes</small>	5	11.563	6.750 oct.	30.8 lbs.
			6	14.375	8.000 oct.	49 lbs.
8	18.500		9.500 oct.	103 lbs.		
	H (F) Polypropylene	1-1/2	4.100	2.344	2.3	
		2	5.188	3.000	3.8	
	D-HH (M) Polypropylene	1/2	1.700	0.750	0.3	
		3/4	2.090	1.000	0.9	
	H-W (F) Polypropylene	1-1/2	4.240	2.344	1.9	
		2	5.465	2.813	4	
	HF (Flange)	4	8.125	8.750	28.8 lbs.	
		5	10.560	10.000	34.3 lbs.	
		6	12.625	11.000	49 lbs.	
		8	16.625	13.500	120 lbs.	
		10	20.750	16.000	193 lbs.	

Based on the largest/heaviest version of each type.

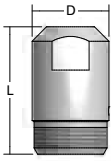
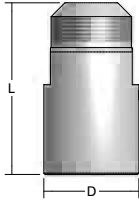
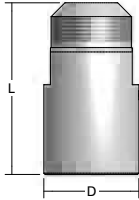
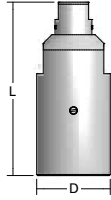
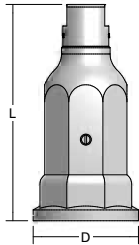
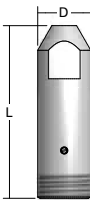
Nozzle	Nozzle Type	Inlet Conn. (in.)	L (in.)	D (Dia.) (in.)	Net Weight (oz.)
	HH (M) HH-W (M)	1/8	0.875	0.500	0.5
		1/4	0.880	0.531	0.5
		3/8	0.940	0.656	1
		1/2	1.156	0.813	1.5
		3/4	1.531	1.063	3.5
		1	2.031	1.313	7
	HH-W (M) (Wide angle only) Standard angle not available for these sizes	1-1/4	2.750	1.688	21.4
		1-1/2	3.250	2.000	28.7
	HD (F)	3/4	2.125	1.250	6
		1	2.688	1.500	10.4
		1-1/4	3.375	1.875	25.6
		1-1/2	4.063	2.250	47.3
		2	5.063	2.750	66.3
		2-1/2	6.250	3.250	7.9 lbs.
		3	7.313	4.000	12.6 lbs.
			H-15 (F)	3/4	2.844
1	3.625			1.500	19
1-1/4	4.625			1.875	36.7
1-1/2	5.000			2.313	39.3
2	7.219			3.000	43.8
2-1/2	8.656			3.109	6.2 lbs.
	H-15 (F) Cast	3	10.563	4.125	7.6 lbs.
		4	13.313	5.438	14.8 lbs.
		5	16.875	6.750	39 lbs.
	HH-30 (M)	1	3.625	1.313	16
		1-1/4	6.090	1.750	41
		1-1/2	6.190	1.875	47
		2	7.859	2.375	11.7 lbs.
		2-1/2	10.375	2.875	12 lbs.
		3	10.375	3.500	31.9 lbs.

Based on the largest/heaviest version of each type.



OVERVIEW: QUICK FULLJET AND PROMAX QUICK FULLJET

- Reduce maintenance time – bodies remain on pipe/header; quick quarter-turn removes/installs spray tips with automatic alignment
- Save on nozzle replacement costs – bodies can be reused, only spray tips are replaced
- Spray angles: Standard – 43° to 91°, Narrow – 15° or 30°, Wide – 102° to 120°
- Uniform spray distribution from .10 to 19.4 gpm (.38 to 72 lpm)
- Operating pressures up to 300 psi (20 bar)
- Choice of metal or ProMax materials. ProMax features:
 - ProMax material, a special grade of polypropylene, resists build-up and chemical attack; for use up to 150 psi (10 bar)
 - Internal O-ring provides a positive seal between the body and tip; seal remains attached to tip eliminating accidental loss
 - Optional external O-ring protects nozzle from contaminants
 - Tips are color-coded for easy flow rate identification

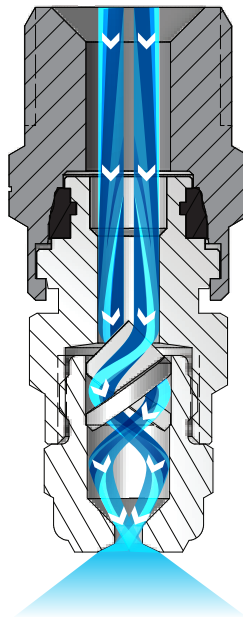

Quick FullJet and ProMax Quick FullJet Nozzles

The liquid enters the nozzle and proceeds through the vane. The vane causes the liquid to swirl. The design of the nozzle ensures the liquid continues to swirl as it enters the orifice. The liquid breaks up as it exits the nozzle orifice forming a well-defined cone pattern. The drops are uniform in size and distributed equally throughout the spray pattern.

QUICK FULLJET OPTIONS



QGA Spray Tip + QJA Body
1/8" to 1/2" female conn.
Removable cap and vane



QUICK FULLJET® AND PROMAX® QUICK FULLJET NOZZLES

S STANDARD ANGLE SPRAY | **W** WIDE ANGLE SPRAY

**FULL
CONE**

PROMAX QUICK FULLJET OPTIONS

 <p>QPHA Spray Tip + QPPA Body 1/8" to 1/2" male conn. Optional external O-ring</p>	 <p>QPHA Spray Tip – Brown QPHA-1 .1 gpm (.38 lpm) Use with QPPA body</p>	 <p>QPHA Spray Tip – White QPHA-1.5 .15 gpm (.57 lpm) QPHA-2.8W .28 gpm (1.1 lpm) Use with QPPA body</p>	 <p>QPHA Spray Tip – Gray QPHA-2 .2 gpm (.76 lpm) Use with QPPA body</p>
 <p>QPHA Spray Tip – Yellow QPHA-6.5 .65 gpm (2.5 lpm) QPHA-10W 1.0 gpm (3.8 lpm) Use with QPPA body</p>	 <p>QPHA Spray Tip – Beige QPHA-8 .8 gpm (3.1 lpm) Use with QPPA body</p>	 <p>QPHA Spray Tip – Blue QPHA-10 1.0 gpm (3.8 lpm) QPHA-12W 1.2 gpm (4.6 lpm) Use with QPPA body</p>	 <p>QPHA Spray Tip – Red QPHA-15 1.5 gpm (5.7 lpm) QPHA-14W 1.4 gpm (5.3 lpm) Use with QPPA body</p>

Capacities at 10 psi (0.7 bar).

ORDERING INFORMATION

METAL QUICK FULLJET

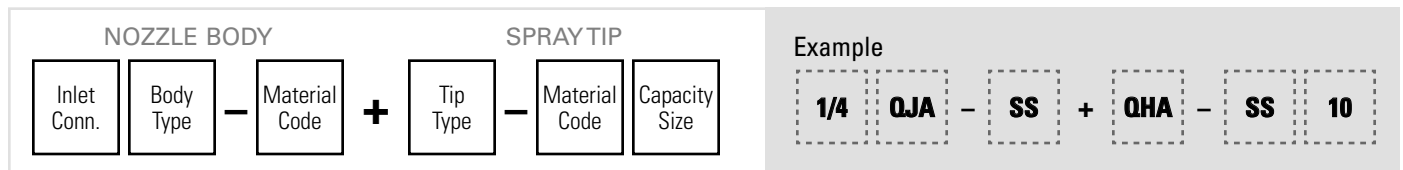

BSPT connections require the addition of a "B" prior to the inlet connection.

PROMAX QUICK FULLJET



Optional external O-ring for ProMax Quick FullJet nozzle: CP7717-2/17-VI

BSPT connections require the addition of a "B" prior to the inlet connection.

**RELATIVE DROP SIZE
IN MICRONS**

 10 to 100	 100 to 500	 500 to 1000	 1000 to 5000
---	--	---	--

Drop size will vary based on flow rate and pressure.

QUICK REFERENCE GUIDE

Model	Connection	Connection Size (in.)	Materials	Page Number	
				Performance Data	Dimensions and Weights
QJA and QJLA bodies	F	1/8 to 1/2	Brass, 303 stainless steel (SS)	–	B19
QJJA and QJJLA bodies	M	1/8 to 1/2		–	
QGA, QLGA, QHA and QLHA spray tips	NA	NA		B17	
OPPA body	M	1/4 to 3/8	ProMax	–	
OPHA spray tips	NA	NA		B17	
QGA-W, QLGA-W, QHA-W and QLHA-W spray tips	NA	NA	Brass, 303 stainless steel (SS)	B18	
OPHA-W spray tips	NA	NA	ProMax		
QGA-15, QLGA-15, QGA-30 and QLGA-30 spray tips	NA	NA	Brass, 303 stainless steel (SS)		

F = female thread; M = male thread. NA = not applicable. There is no material code for brass. Leave material code blank when ordering. For ProMax, the material code is built into part number. Other materials available upon request.

Brass Quick FullJet nozzles have Buna-N seal. Stainless steel FullJet nozzles have a Viton® seal.

For more dimensions and sizes, contact your sales engineer.

PROMAX QUICKJET NOZZLE MAXIMUM PRESSURES AT VARIOUS TEMPERATURES

The recommended maximum operating pressure for ProMax QuickJet nozzles varies based on temperature. As temperature increases, the recommended operating pressure decreases. Do not use outside of operating range.

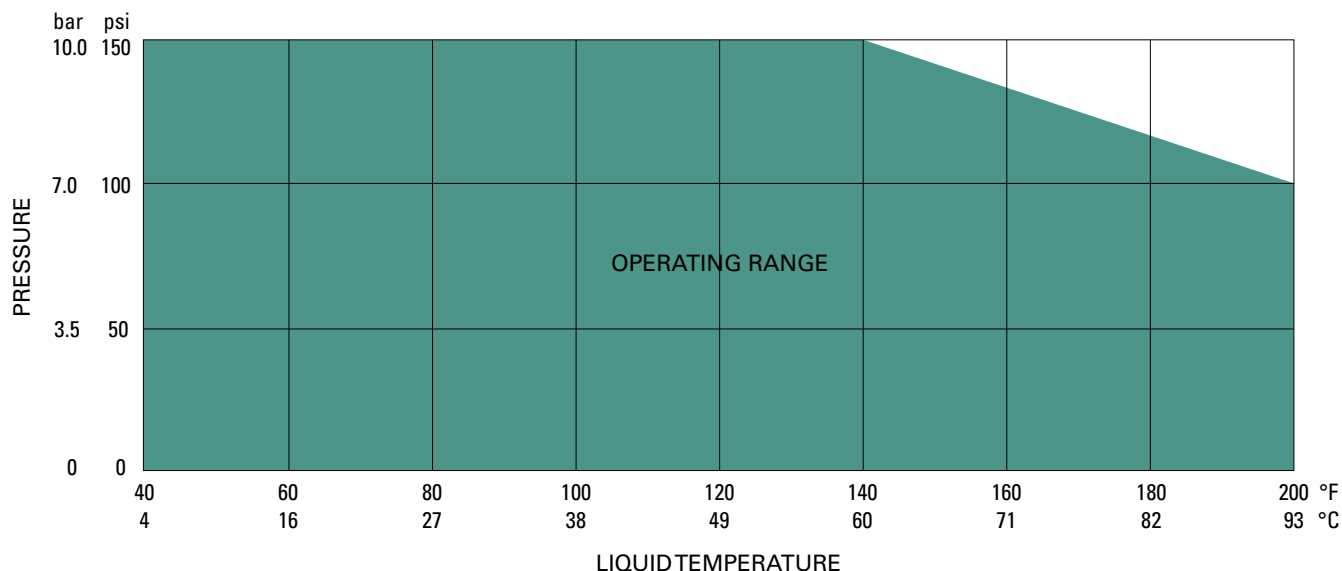

QUICK FULLJET® AND PROMAX® QUICK FULLJET NOZZLES

S STANDARD ANGLE SPRAY

FULL CONE

S PERFORMANCE DATA:
STANDARD ANGLE SPRAY

Inlet Conn. (in.)	Quick FullJet Tip Type					Capacity Size	Orifice Dia. Nom. (in.)	Max. Free Passage Dia. (in.)	Flow Rate Capacity (gallons per minute)								Spray Angle (°)		
	QGA	QLGA	QHA	QLHA	QPHA				7 psi	10 psi	20 psi	40 psi	70 psi	80 psi	100 psi	150 psi	7 psi	20 psi	80 psi
1/8, 1/4, 3/8, 1/2	•				•	1	.031	.025	–	.10	.14	.19	.24	.26	.29	.35	–	58	53
	•				•	1.5	.047	.025	.13	.15	.21	.28	.37	.39	.43	.52	52	65	59
	•				•	2	.047	.040	.17	.20	.28	.38	.49	.52	.58	.70	43	50	46
	•				•	2.5	.053	.040	.21	.25	.34	.47	.61	.65	.72	.87	43	50	46
	•				•	3	.063	.040	.25	.30	.41	.57	.73	.78	.87	1.0	52	65	59
	•		•		•	3.5	.063	.050	.30	.35	.48	.66	.86	.91	1.0	1.2	43	50	46
	•				•	4	.067	.050	.34	.40	.55	.76	.98	1.0	1.2	1.4	48	55	50
	•				•	5	.078	.050	.42	.50	.69	.95	1.2	1.3	1.4	1.7	52	65	59
1/4, 3/8, 1/2	•		•		•	6.5	.094	.063	.55	.65	.89	1.2	1.6	1.7	1.9	2.3	45	50	46
					•	8	.096	.063	.68	.80	1.1	1.5	2.0	2.1	2.3	2.8	54	65	61
	•		•		•	10	.109	.063	.85	1.0	1.4	1.9	2.4	2.6	2.9	3.5	58	67	61
					•	15	.141	.063	1.3	1.5	2.1	2.8	3.7	3.9	4.3	5.2	80	85	80
3/8, 1/2	•					9.5	.109	.094	.81	.95	1.3	1.8	2.3	2.5	2.7	3.3	45	50	46
	•			•		15	.141	.094	1.3	1.5	2.1	2.8	3.7	3.9	4.3	5.2	64	67	61
	•					20	.156	.109	1.7	2.0	2.8	3.8	4.9	5.2	5.8	7.0	76	80	73
	•			•		22	.188	.109	1.9	2.2	3.0	4.2	5.4	5.7	6.3	7.6	87	90	82
1/2		•				16	.141	.125	1.4	1.6	2.2	3.0	3.9	4.2	4.6	5.6	48	50	46
		•				20	.161	.125	1.7	2.0	2.8	3.8	4.9	5.2	5.8	7.0	62	65	59
		•		•		25	.188	.125	2.1	2.5	3.4	4.7	6.1	6.5	7.2	8.7	64	67	61
		•				30	.189	.141	2.5	3.0	4.1	5.7	7.3	7.8	8.7	10.4	69	72	66
		•				32	.203	.141	2.7	3.2	4.4	6.1	7.8	8.3	9.2	11.1	72	75	68
		•				40	.250	.141	3.4	4.0	5.5	7.6	9.8	10.4	11.5	13.9	88	91	83
		•				50	.266	.156	4.2	5.0	6.9	9.5	12.2	13.0	14.4	17.4	91	94	86

Maximum Free Passage Diameter is the maximum diameter as listed of foreign matter that can pass through the nozzle without clogging.

Highlighted column shows the rated pressure.



**FULL
CONE**

QUICK FULLJET® AND PROMAX® QUICK FULLJET NOZZLES

W WIDE ANGLE SPRAY | **N** NARROW ANGLE SPRAY

W PERFORMANCE DATA:
WIDE ANGLE SPRAY

Inlet Conn. (in.)	Quick FullJet Tip Type					Capacity Size	Orifice Dia. Nom. (in.)	Max. Free Passage Dia. (in.)	Flow Rate Capacity (gallons per minute)						Spray Angle (°)		
	QGA-W	QLGA-W	QHA-W	QLHA-W	QPHA-W				7 psi	10 psi	15 psi	40 psi	70 psi	80 psi	5 psi	10 psi	80 psi
1/8, 1/4, 3/8, 1/2	•		•		•	2.8W	.063	.040	-	.28	.33	.52	.66	.70	-	120	102
	•				•	4.3W	.078	.040	-	.43	.51	.79	1.0	1.1	-	120	102
	•		•		•	5.6W	.094	.040	.48	.56	.67	1.0	1.3	1.4	-	120	102
	•		•		•	8W	.094	.050	.68	.80	.96	1.5	1.9	2.0	-	120	103
1/4, 3/8, 1/2	•		•		•	10W	.109	.050	.85	1.0	1.2	1.8	2.4	2.5	112	120	103
	•		•		•	12W	.125	.050	1.0	1.2	1.4	2.2	2.8	3.0	114	120	103
	•		•		•	14W	.141	.063	1.2	1.4	1.7	2.6	3.3	3.5	114	120	103
3/8, 1/2	•					17W	.156	.063	1.5	1.7	2.0	3.1	4.0	4.2	114	120	103
	•			•		20W	.172	.094	1.7	2.0	2.4	3.7	4.7	5.0	114	120	104
	•					24W	.188	.094	2.1	2.4	2.9	4.4	5.7	6.0	114	120	104
	•					27W	.203	.109	2.3	2.7	3.2	5.0	6.4	6.7	114	120	106
1/2		•				30W	.219	.109	2.6	3.0	3.6	5.5	7.1	7.5	114	120	108
		•				35W	.234	.125	3.0	3.5	4.2	6.4	8.2	8.7	114	120	108
		•				40W	.250	.125	3.4	4.0	4.8	7.4	9.4	10.0	114	120	108
		•				45W	.250	.141	3.8	4.5	5.4	8.3	10.6	11.2	114	120	110
		•				50W	.266	.156	4.3	5.0	6.0	9.2	11.8	12.5	114	120	112

Maximum Free Passage Diameter is the maximum diameter as listed of foreign matter that can pass through the nozzle without clogging.

Highlighted column shows the rated pressure.

N PERFORMANCE DATA:
NARROW ANGLE SPRAY

Body Inlet Conn. (in.)	Quick FullJet Tip Type				Capacity Size	Orifice Dia. Nom. (in.)	Flow Rate Capacity (gallons per minute)								Spray Angle (°)				
	QGA-15	QGA-30	QLGA-15	QLGA-30			10 psi	15 psi	20 psi	40 psi	80 psi	100 psi	150 psi	200 psi	300 psi	10 psi	15 psi	40 psi	100 psi
1/8, 1/4, 3/8, 1/2	•				1507	.063	.35	.43	.49	.70	.99	1.1	1.4	1.6	1.9	13	14	15	15
	•				1514	.094	.70	.86	.99	1.4	2.0	2.2	2.7	3.1	3.8	13	14	15	15
1/4, 3/8, 1/2	•				1530	.125	1.5	1.8	2.1	3.0	4.2	4.7	5.8	6.7	8.2	13	14	15	15
3/8, 1/2	•				1550	.172	2.5	3.1	3.5	5.0	7.1	7.9	9.7	11.2	13.7	13	14	15	15
1/2			•		1590	.219	4.5	5.5	6.4	9.0	12.7	14.2	17.4	20	25	13	14	15	15
1/8, 1/4, 3/8, 1/2		•			3001.4	.031	.070	.086	.099	.14	.20	.22	.27	.31	.38	11	17	30	31
		•			3002.5	.031	.13	.15	.18	.25	.35	.40	.48	.56	.68	12	17	30	32
		•			3004	.047	.20	.24	.28	.40	.57	.63	.77	.89	1.1	20	26	30	32
		•			3007	.063	.35	.43	.49	.70	.99	1.1	1.4	1.6	1.9	20	23	30	30
1/4, 3/8, 1/2		•			3009	.078	.45	.55	.64	.90	1.3	1.4	1.7	2.0	2.5	20	23	30	30
3/8, 1/2			•		3014	.094	.70	.86	.99	1.4	2.0	2.2	2.7	3.1	3.8	20	25	30	30

Highlighted column shows the rated pressure.



QUICK FULLJET® AND PROMAX® QUICK FULLJET NOZZLES

S STANDARD ANGLE SPRAY | **W** WIDE ANGLE SPRAY | **N** NARROW ANGLE SPRAY

FULL CONE

DIMENSIONS AND WEIGHTS

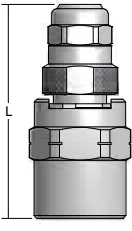
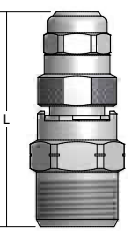
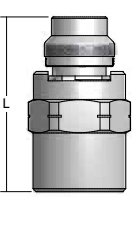
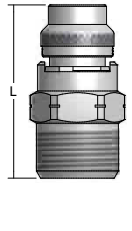
Nozzle	Nozzle Type	Inlet Conn. (in.)	L (in.)	Hex. (in.)	W (Width) (in.)	Net Weight (oz.)
	QJA (F) + QGA	1/8, 1/4, 3/8, 1/2	2.352	1	–	4.2
	QJA (F) + QGA-W	1/8, 1/4, 3/8, 1/2	2.662	1	–	4.3
	QJLA (F) + QLGA	3/8, 1/2	3.078	1-1/8	–	8.7
	QJLA (F) + QLGA-W	3/8, 1/2	3.265	1-1/8	–	9.3
	QJJA (M) + QGA	1/8, 1/4, 3/8, 1/2	2.250	7/8	–	3.8
	QJJA (M) + QGA-W	1/8, 1/4, 3/8, 1/2	2.565	7/8	–	4.2
	QJJLA (M) + QLGA	3/8, 1/2	3.115	1-1/8	–	8.2
	QJJLA (M) + QLGA-W	3/8, 1/2	3.290	1-1/8	–	8.9
	QJA (F) + QHA	1/8, 1/4, 3/8, 1/2	1.980	1	–	3.8
	QJA (F) + QHA-W	1/8, 1/4, 3/8, 1/2	1.895	1	–	3.5
	QJLA (F) + QLHA	3/8, 1/2	2.368	1-1/8	–	5.9
	QJLA (F) + QLHA-W	3/8, 1/2	2.140	1-1/8	–	5
	QJJA (M) + QHA	1/8, 1/4, 3/8, 1/2	1.773	7/8	–	3.2
	QJJA (M) + QHA-W	1/8, 1/4, 3/8, 1/2	1.802	7/8	–	3.5
	QJJLA (M) + QLHA	3/8, 1/2	2.375	1-1/8	–	5.4
	QJJLA (M) + QLHA-W	3/8, 1/2	2.171	1-1/8	–	5

Based on the largest/heaviest version of each type.

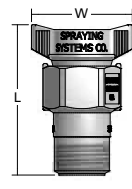
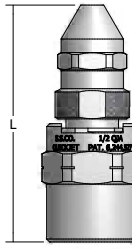
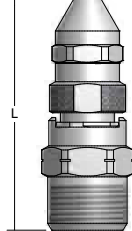
Nozzle	Nozzle Type	Inlet Conn. (in.)	L (in.)	Hex. (in.)	W (Width) (in.)	Net Weight (oz.)
	QPPA (M) + QPHA or QPHA-W	1/8, 1/4, 3/8, 1/2	1.899	7/8	1.250	0.5
	QJA (F) + QGA-15 or QGA-30	1/8, 1/4, 3/8, 1/2	2.736	1	–	5.5
	QJLA (F) + QLGA-15 or QLGA-30	3/8, 1/2	3.425	1-1/8	–	9.7
	QJJA (M) + QGA-15 or QGA-30	1/8, 1/4, 3/8, 1/2	2.635	7/8	–	4.6
	QJJLA (M) + QLGA-15 or QLGA-30	3/8, 1/2	3.465	1-1/8	–	9.2

Based on the largest/heaviest version of each type.

BODY TYPES

Inlet Conn. (in.)	QuickJet and ProMax QuickJet Bodies				
	Conn. F		Conn. M		
	QJA	QJLA	QJJA	QJJLA	QPPA
1/8	•		•		•
1/4	•		•		•
3/8	•	•	•	•	•
1/2	•	•	•	•	•

FULL
CONE

FULLJET® MAXIMUM FREE PASSAGE (MFP) NOZZLES

S STANDARD ANGLE SPRAY

OVERVIEW: FULLJET MAXIMUM FREE PASSAGE (MFP)

- Solid cone-shaped spray pattern
- Patented vane design provides largest free passage of maximum free passage nozzles; ideal for use with fluids with particulates
- More uniform spray distribution than other large free passage nozzles
- Uniform spray distribution from 1.4 to 57 gpm (5.3 to 216 lpm)
- Operating pressures up to 80 psi (6 bar)
- Spray angles: 60°, 90° and 115°

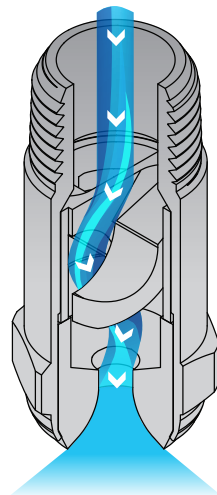

MFP FullJet Nozzles

The liquid comes in contact with the vane as it enters the nozzle. The unique vane design stabilizes the fluid before it enters the swirl region. The swirling liquid passes through the nozzle and breaks up as it exits the nozzle orifice. The spray pattern produced is a well-defined cone shape consisting of uniform drops equally distributed throughout the spray pattern. The large, open passages in the nozzle minimize clogging.

FULLJET MAXIMUM FREE PASSAGE (MFP) OPTIONS

PATENTED VANE TECHNOLOGY

PROVIDES SUPERIOR PERFORMANCE

PLUS NEW SIZES AND CAPACITIES NOW AVAILABLE



HMFP
3/8" to 1-1/2" female conn.



HMFP
2" to 3" female conn.



HHMFP
3/8" to 1-1/2" male conn.



HHMFP
2" to 3" male conn.

ORDERING INFORMATION

FULLJET MAXIMUM FREE PASSAGE (MFP)

Inlet Conn.	Nozzle Type	—	Material Code	Spray Angle	Capacity Size	Example
						3/4 HHMFP — SS 90 70

BSPT connections require the addition of a "B" prior to the inlet connection. Use material code SS for 316 stainless steel MFP nozzles.

RELATIVE DROP SIZE IN MICRONS



Drop size will vary based on flow rate and pressure.

QUICK REFERENCE GUIDE

Model	Connection/Type	Connection Size (in.)	Materials	Page Number	
				Performance Data	Dimensions and Weights
HMFP	F	3/8 to 1	316 stainless steel vane and choice of brass or 316 stainless steel (SS) bodies	B21-B22	B23
	F	1-1/4 to 3	316 stainless steel vane and 316 stainless steel (SS) body		
HHMFP	M	3/8 to 1	316 stainless steel vane and choice of brass or 316 stainless steel (SS) bodies	B21-B22	
	M	1-1/4 to 3	316 stainless steel vane and 316 stainless steel (SS) body		

F = female thread; M = male thread. There is no material code for brass. Leave material code blank when ordering. Other materials available upon request. For more dimensions and sizes, contact your sales engineer.

S PERFORMANCE DATA:
STANDARD ANGLE SPRAY



Inlet Conn. (in.)	Nozzle Type		Capacity Size	Approx. Free Passage Dia. (in.)	Flow Rate Capacity (gallons per minute)				Spray Angle (°)					
									60° Series		90° Series		115° Series	
	HMFP	HHMFP			10 psi	20 psi	40 psi	80 psi	10 psi	40 psi	10 psi	40 psi	10 psi	40 psi
3/8	●	●	14	.125	1.4	1.8	2.4	3.2	60	62	90	84	115	100
	●	●	22	.156	2.2	2.9	3.8	5.1	60	62	90	84	115	100
	●	●	32	.188	3.2	4.2	5.6	7.4	60	62	90	84	115	100
1/2	●	●	32	.188	3.2	4.2	5.6	7.4	60	62	90	84	115	100
	●	●	51	.219	5.1	6.7	8.9	11.7	60	62	90	84	115	100
	●	●	57	.250	5.7	7.5	9.9	13.1	60	62	90	84	115	100
3/4	●	●	70	.281	7.0	9.2	12.2	16.1	60	62	90	84	115	100
	●	●	84	.313	8.4	11.1	14.6	19.3	60	62	90	84	115	100
	●	●	100	.344	10.0	13.2	17.4	23	60	62	90	84	115	100
	●	●	120	.375	12.0	15.8	21	28	60	62	90	84	115	100
1	●	●	120	.375	12.0	15.8	21	28	60	62	90	84	115	100
	●	●	150	.406	15.0	19.5	25	33	60	62	90	88	115	105
	●	●	170	.437	17.0	22	29	37	60	62	90	88	115	105
1-1/4	●	●	170	.437	17.0	22	29	37	60	62	90	88	115	105
	●	●	200	.469	20	26	34	44	60	62	90	88	115	105
	●	●	220	.500	22	29	37	48	60	62	90	88	115	105
	●	●	240	.531	24	31	41	53	60	62	90	88	115	105
	●	●	260	.562	26	34	44	57	60	62	90	88	115	105

Approximate Free Passage Diameter is the approximate diameter as listed of foreign matter that can pass through the nozzle without clogging. **Highlighted column shows the rated pressure.**

FULL
CONE

FULLJET® MAXIMUM FREE PASSAGE (MFP) NOZZLES

S STANDARD ANGLE SPRAY

S PERFORMANCE DATA:
STANDARD ANGLE SPRAY

Inlet Conn. (in.)	Nozzle Type		Capacity Size	Approx. Free Passage Dia. (in.)	Flow Rate Capacity (gallons per minute)				Spray Angle (°)					
									60° Series		90° Series		115° Series	
	HMFP	HHMFP			10 psi	20 psi	40 psi	80 psi	10 psi	40 psi	10 psi	40 psi	10 psi	40 psi
1-1/2	●	●	240	.54	24	32	43	58	60	59	89	89	108	104
	●	●	260	.558	26	35	47	63	62	61	90	92	113	103
	●	●	280	.571	28	38	50	68	62	62	89	91	113	107
	●	●	300	.59	30	42	58	80	63	62	93	92	114	108
	●	●	350	.63	35	48	67	93	63	63	91	93	117	113
	●	●	400	.66	40	55	77	106	64	64	92	93	120	115
	●	●	450	.7	45	62	86	119	65	63	92	91	117	116
2	●	●	500	.76	50	70	97	135	59	58	90	86	103	98
	●	●	600	.82	60	84	116	162	61	58	89	86	108	102
	●	●	700	.86	70	98	136	189	62	57	92	91	114	106
	●	●	800	.97	80	111	155	216	60	57	93	89	113	111
2-1/2	●	●	1000	1	100	137	188	258	61	58	92	90	112	112
	●	●	1200	1.21	120	165	226	309	63	59	94	91	110	108
	●	●	1400	1.36	140	192	263	361	62	60	93	92	113	111
	●	●	1700	1.41	170	233	320	438	62	60	89	88	112	110
3	●	●	1800	1.55	180	242	325	436	61	59	90	92	112	108
	●	●	2000	1.73	200	269	361	485	63	61	93	91	112	109
	●	●	2400	2.2	240	322	433	582	62	60	95	93	114	111

Approximate Free Passage Diameter is the approximate diameter as listed of foreign matter that can pass through the nozzle without clogging.

Highlighted column shows the rated pressure.



DIMENSIONS AND WEIGHTS

Nozzle	Nozzle Type	Inlet Conn. (in.)	Spray Angle	Capacity Size	L (in.)	Hex. (in.)	Net Weight (oz.)
	HMFP (F)	3/8	60°, 90°, 115°	14, 22	1.460	13/16	2.4
			60°, 90°, 115°	32	1.701	13/16	2.5
		1/2	60°, 90°, 115°	32	1.770	1	4.5
			60°, 90°, 115°	51, 57	2.120	1	4.6
		3/4	60°, 90°, 115°	70	2.400	1-1/4	8.9
			60°, 90°, 115°	84	2.637	1-3/8	12.6
			60°, 90°, 115°	100	2.894	1-3/8	13.3
		1	60°, 90°, 115°	120	3.070	1-3/8	12.9
		1	60°, 90°, 115°	120, 150, 170	3.250	1-3/4	22.5
		1-1/4	60°, 90°, 115°	170, 200, 220, 240, 260	3.750	2	30.5
1-1/2	60°, 90°, 115°	240, 260, 280, 300, 350, 400, 450	4.380	2-3/16	35.3		
	HMFP (F)	2	60°, 90°, 115°	500, 600, 700, 800	6.528	2-3/4 dia.	52.9
		2-1/2	60°, 90°, 115°	1000, 1200, 1400, 1700	8.000	3-13/16 dia.	93.5
		3	60°, 90°, 115°	1800, 2000, 2400	9.440	4-3/16 dia.	114.6
	HHMFP (M)	3/8	60°, 90°, 115°	14, 22	1.000	11/16	1.4
			60°, 90°, 115°	32	1.701	3/4	2
		1/2	60°, 90°, 115°	32	1.225	7/8	2.4
			60°, 90°, 115°	51, 57	2.198	1	4.9
		3/4	60°, 90°, 115°	70	1.810	1-1/8	5
			60°, 90°, 115°	84	2.713	1-3/8	11.5
			60°, 90°, 115°	100	2.980	1-3/8	12.1
		1	60°, 90°, 115°	120	3.100	1-3/8	11.5
		1	60°, 90°, 115°	120, 150, 170	3.250	1-3/4	22.5
		1-1/4	60°, 90°, 115°	170, 200, 220, 240, 260	3.750	2	32
1-1/2	60°, 90°, 115°	240, 260, 280, 300, 350, 400, 450	4.380	2-3/16	36.7		
	HHMFP (M)	2	60°, 90°, 115°	500, 600, 700, 800	6.528	2-3/4 dia.	52.9
		2-1/2	60°, 90°, 115°	1000, 1200, 1400, 1700	8.000	3-13/16 dia.	93.5
		3	60°, 90°, 115°	1800, 2000, 2400	9.440	4-3/16 dia.	114.6

Based on the largest/heaviest version of each type.



**FULL
CONE**

SPIRALJET® NOZZLES: STANDARD ANGLE SPRAY AND EXTRA LARGE FREE PASSAGE DESIGN

S STANDARD ANGLE SPRAY

OVERVIEW: SPIRALJET

- Solid cone-shaped spray pattern
- Open passages ideal for use with fluids with particulates
- Maximum liquid throughput for a given pipe size
- Spray angles from 60° to 170°
- Uniform spray distribution from .7 to 3320 gpm (2.7 to 11967 lpm)
- Operating pressures up to 400 psi (25 bar)
- Compact size enables easy installation or retrofit on most pipe systems
- Certain nozzles available with UL listing  for fire protection applications

For other certifications, contact your sales engineer.

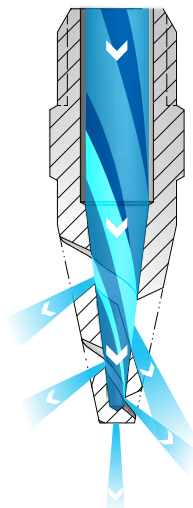

SpiralJet HHSJ and HHSJX Nozzles

The liquid enters the nozzle and passes through the orifice. The liquid exits the nozzle through the voids in the spiral. As it deflects off the spiral surface, a full cone pattern is formed.

SPIRALJET OPTIONS



HHSJ

1/4" to 2" male conn.
Hex. body style/316 stainless steel

Other body styles, connection sizes and materials available.
See Quick Reference Guide.



HHSJX

3/8" to 2" male conn.
Extra large free passage design
Hex. body style/brass

Other body styles, connection sizes and materials available.
See Quick Reference Guide.

ORDERING INFORMATION

SPIRALJET

Inlet Conn.	Nozzle Type	—	Material Code	Spray Angle	Capacity Size	Example
						1/4 HHSJ — SS 120 07

BSPT connections require the addition of a "B" prior to the inlet connection.

**RELATIVE DROP SIZE
IN MICRONS**

 10 to 100	 100 to 500	 500 to 1000	 1000 to 5000
---	--	---	--

Drop size will vary based on flow rate and pressure.

QUICK REFERENCE GUIDE

Model	Connection/Type	Connection Size (in.)	Materials	Page Number	
				Performance Data	Dimensions and Weights
HHSJ	M, Hex.	1/4 to 2	Brass, 316 stainless steel (316SS)	B25	B26
	M, Flats, Cast	1/4 to 4	316 stainless steel (SS)		
	M, Round	1/4 to 4	Polyvinyl chloride (PVC), PTFE (TEF)		
HHSJX	M, Hex.	3/8 to 2	Brass	B26	
	M, Flats, Cast	3/8 to 2	316 stainless steel (SS)		
	M, Round	3/8 to 2	Polypropylene (PP), Polyvinyl chloride (PVC)		

M = male thread. There is no material code for brass. Leave material code blank when ordering. Other materials available upon request.
 For more dimensions and sizes, contact your sales engineer.

S PERFORMANCE DATA:
STANDARD ANGLE SPRAY



Inlet Conn. (in.)	Nozzle Type	Spray Angle at 10 psi					Capacity Size	Orifice Dia. Nom. (in.)	Max. Free Passage Dia. (in.)	Flow Rate Capacity (gallons per minute)				
		60°	90°	120°	150°	170°				10 psi	20 psi	40 psi	100 psi	400 psi
1/4	●	●	●	●			07	.094	.094	.70	.99	1.4	2.2	4.4
	●	●	●	●	●	●	13	.125	.125	1.3	1.8	2.6	4.1	8.2
	●	●	●	●	●	●	20	.156	.125	2.0	2.8	4.0	6.3	12.6
3/8	●	●					07	.094	.094	.70	.99	1.4	2.2	4.4
	●	●					13	.125	.125	1.3	1.8	2.6	4.1	8.2
	●	●					20	.156	.125	2.0	2.8	4.0	6.3	12.6
	●	●	●	●	●	●	30	.188	.125	3.0	4.2	6.0	9.5	19.0
	●	●	●	●	●	●	40	.219	.125	4.0	5.7	8.0	12.6	25
	●	●	●	●	●	●	53	.250	.125	5.3	7.5	10.6	16.8	34
	●	●	●	●	●	●	82	.313	.125	8.2	11.6	16.4	26	52
1/2	●	●	●	●	●	●	120	.375	.188	12.0	17.0	24	38	76
	●	●	●	●	●	●	164	.438	.188	16.4	23	33	52	104
	●					●	210	.500	.188	21	30	42	66	133
3/4	●	●	●	●	●	●	210	.500	.188	21	30	42	66	133
1	●	●	●	●	●	●	340	.625	.250	34	48	68	108	215
	●	●	●	●	●	●	470	.750	.250	47	66	94	149	297
1-1/2	●	●	●	●	●	●	640	.875	.313	64	91	128	202	405
	●	●	●	●	●	●	820	1.000	.313	82	116	164	259	519
	●	●	●	●	●	●	960	1.125	.313	96	136	192	304	607
2	●	●	●	●	●	●	1400	1.375	.438	140	198	280	443	885
	●	●	●	●	●	●	1780	1.500	.438	178	252	356	563	1126
3	●	●	●	●			2560	1.750	.563	256	362	512	810	1619
	●	●	●	●			3360	2.000	.563	336	475	672	1063	2125
4	●	●	●	●			5250	2.500	.625	525	742	1050	1660	3320

Maximum Free Passage Diameter is the maximum diameter as listed of foreign matter that can pass through the nozzle without clogging.
Highlighted column shows the rated pressure.



S PERFORMANCE DATA:
STANDARD ANGLE SPRAY

Inlet Conn. (in.)	Nozzle Type	Spray Angle at 10 psi		Capacity Size	Orifice Dia. Nom. (in.)	Max. Free Passage Dia. (in.)	Flow Rate Capacity (gallons per minute)				
		HHSJX	90°				120°	10 psi	20 psi	40 psi	100 psi
3/8	•	•	•	30	.188	.188	3.0	4.2	6.0	9.5	19.0
	•	•	•	40	.219	.219	4.0	5.7	8.0	12.6	25
	•	•	•	53	.250	.250	5.3	7.5	10.6	16.8	34
	•	•	•	82	.313	.313	8.2	11.6	16.4	26	52
1/2	•	•	•	120	.375	.375	12.0	17.0	24	38	76
	•	•	•	164	.438	.438	16.4	23	33	52	104
3/4	•	•	•	210	.500	.500	21	30	42	66	133
1	•	•	•	340	.625	.625	34	48	68	108	215
	•	•	•	470	.750	.750	47	66	94	149	297
1-1/2	•	•	•	640	.875	.875	64	91	128	202	405
	•	•	•	820	1.000	1.000	82	116	164	259	519
	•	•	•	960	1.125	1.125	96	136	192	304	607
2	•	•	•	1400	1.375	1.375	140	198	280	443	885
	•	•	•	1780	1.500	1.500	178	252	356	563	1126

Maximum Free Passage Diameter is the maximum diameter as listed of foreign matter that can pass through the nozzle without clogging.

Highlighted column shows the rated pressure.

DIMENSIONS AND WEIGHTS

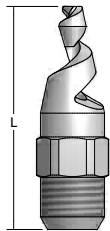
Nozzle	Nozzle Type	Inlet Conn. (in.)	L (in.)	Hex. (in.)	Net Weight (oz.)
	HHSJ (M)	1/4	2.125	9/16	1
		3/8	2.375	11/16	1.8
		1/2	3.125	7/8	3.5
		3/4	3.438	1-1/16	5.4
		1	4.563	1-3/8	10
		1-1/2	6.750	2	27
		2	6.875	2-1/2	35
		3	11.875	3-3/4	92
		4	13.250	4-1/2	10.3 lbs.

Based on the largest/heaviest version of each type.

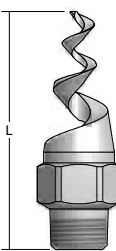
Nozzle	Nozzle Type	Inlet Conn. (in.)	L (in.)	Hex. (in.)	Net Weight (oz.)
	HHSJX (M)	3/8	2.750	7/8	3
		1/2	3.375	1-1/16	4.5
		3/4	4.625	1-3/8	8
		1	5.125	1-3/4	18
		1-1/2	6.750	2	30
		2	11.000	3	88

Based on the largest/heaviest version of each type.

OVERVIEW: DISTRIBOJET EXTRA LARGE FREE PASSAGE

- Solid cone-shaped spray pattern with round impact area
- Extra large flow passages and large open orifice eliminate clogging
- Internal vane is cast as part of the nozzle
- Uniform spray distribution from 27 to 8728 gpm (122 to 32530 lpm)
- Operating pressures up to 60 psi (4 bar); full cone pattern develops at 1 psi (.07 bar)
- 50°, 60°, 80° and 95° spray angles; 50° and 65° styles feature specially designed grooved orifices for accurate flow rates and spray angle control

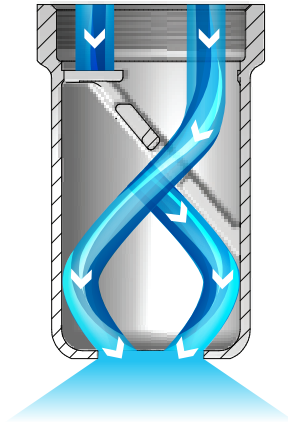

DistroJet R, RF and RR Nozzles

The liquid comes in contact with the vane cast inside the nozzle as it enters. This contact causes the liquid to swirl. As the liquid flows through the extra large flow passages, the liquid continues to swirl. The liquid breaks up as it exits the large open orifice producing a deluge-like cone pattern.

DISTRIBOJET EXTRA LARGE FREE PASSAGE OPTIONS

S



R

2" to 8" female conn.

S



RF

4" to 12" flange conn.

S



RR

2" to 8" male conn.

ORDERING INFORMATION

DISTRIBOJET EXTRA LARGE FREE PASSAGE DESIGN

Inlet Conn.	Nozzle Type	Material Code	Spray Angle	Capacity Size	Example
					2 RR - SS 50 45

BSPT connections require the addition of a "B" prior to the inlet connection.

**RELATIVE DROP SIZE
IN MICRONS**

10 to 100	100 to 500	500 to 1000	1000 to 5000
-----------	------------	-------------	--------------

Drop size will vary based on flow rate and pressure.

FULL
CONE

DISTRIBOJET® NOZZLES: EXTRA LARGE FREE PASSAGE DESIGN

S STANDARD ANGLE SPRAY

QUICK REFERENCE GUIDE

Model	Connection/ Type	Connection Size (in.)	Materials	Page Number	
				Performance Data	Dimensions and Weights
R	F, Cast	2 to 8	Brass, 316 stainless steel (SS)	B28, B29	B29
RR	M, Cast	2 to 8			
RF	Flange, Cast	4 to 12			

F = female thread; M = male thread. There is no material code for brass. Leave material code blank when ordering. Other materials available upon request.
For more dimensions and sizes, contact your sales engineer.

S PERFORMANCE DATA:
STANDARD ANGLE SPRAY



Inlet Conn. (in.)	Nozzle Type												Capacity Size	Flow Rate Capacity (gallons per minute)							
	R				RR				RF					1 psi	3 psi	5 psi	7 psi	10 psi	20 psi	40 psi	60 psi
	Spray Angle																				
	50°	65°	80°	95°	50°	65°	80°	95°	50°	65°	80°	95°									
2	•	•		•	•	•		•					45	27	45	57	66	78	108	148	179
		•		•		•		•					60	36	60	76	89	104	144	198	238
2-1/2	•	•		•	•	•		•					70	42	70	89	103	122	168	230	278
		•		•		•		•					90	54	90	114	133	157	215	296	357
3	•	•		•	•	•		•					110	66	110	139	162	191	263	362	436
		•		•		•		•					140	84	140	177	207	244	335	461	555
4	•	•	•		•	•	•		•	•	•		160	97	160	202	236	278	383	527	635
	•	•		•	•	•		•	•	•		•	190	115	190	240	281	331	455	625	754
		•		•		•		•		•		•	250	151	250	316	369	435	598	823	992
5	•	•	•		•	•	•		•	•	•		250	151	250	316	369	435	598	823	992
	•	•		•	•	•		•	•	•		•	280	169	280	354	413	487	670	922	1111
		•		•		•		•		•		•	380	229	380	481	561	661	909	1251	1508
6	•	•	•		•	•	•		•	•	•		360	217	360	455	532	626	862	1185	1428
	•	•		•	•	•		•	•	•		•	400	241	400	506	591	696	957	1317	1587
		•		•		•		•		•		•	560	338	560	708	827	974	1340	1844	2222
8	•	•	•		•	•	•		•	•	•		650	392	650	822	960	1131	1556	2140	2579
	•	•		•	•	•		•	•	•		•	750	452	750	949	1107	1305	1795	2469	2975
		•		•		•		•		•		•	850	513	850	1075	1255	1479	2034	2798	3372
				•				•				•	1000	603	1000	1265	1477	1740	2393	3292	3967

For orifice information, contact your sales engineer.

Highlighted column shows the rated pressure.



S PERFORMANCE DATA: STANDARD ANGLE SPRAY

Inlet Conn. (in.)	Nozzle Type												Capacity Size	Flow Rate Capacity (gallons per minute)							
	R				RR				RF					1 psi	3 psi	5 psi	7 psi	10 psi	20 psi	40 psi	60 psi
	Spray Angle																				
	50°	65°	80°	95°	50°	65°	80°	95°	50°	65°	80°	95°									
12												●	1400	845	1400	1771	2067	2436	3351	4609	5554
												●	1600	965	1600	2024	2363	2784	3829	5267	6347
												●	1700	1026	1700	2150	2510	2958	4069	5597	6744
												●	1800	1086	1800	2277	2658	3132	4308	5926	7141
												●	2000	1207	2000	2530	2953	3480	4787	6584	7934
												●	2200	1327	2200	2783	3249	3828	5265	7243	8728

For orifice information, contact your sales engineer.
Highlighted column shows the rated pressure.

DIMENSIONS AND WEIGHTS

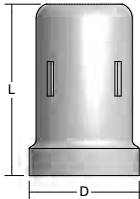
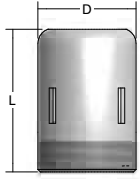
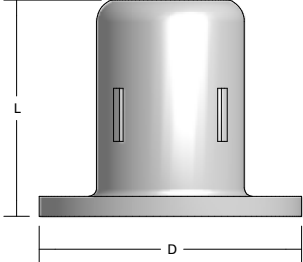
Nozzle	Nozzle Type	Inlet Conn. (in.)	L (in.)	D (Dia.) (in.)	Net Weight (oz.)
	R (F)	2	4.438	2.938	48
		2-1/2	5.469	3.469	88
		3	6.500	4.125	7.5 lbs.
		4	8.125	5.000	13.5 lbs.
		5	10.031	6.375	33 lbs.
		6	11.813	7.625	38.5 lbs.
		8	15.313	9.500	75 lbs.
	RR (M)	2	3.250	2.375	32
		2-1/2	4.000	2.875	84
		3	4.875	3.500	92
		4	6.500	4.500	10 lbs.
		5	8.313	5.563	25 lbs.
		6	9.750	6.625	29 lbs.
		8	13.000	8.625	56 lbs.
	RF (Flange)	4	6.563	8.875	23 lbs.
		5	8.813	9.875	39 lbs.
		6	9.813	10.875	45 lbs.
		8	13.000	13.375	85 lbs.
		12	19.500	19.000	201 lbs.

Based on the largest/heaviest version of each type.

OVERVIEW: FULLJET SQUARE AND OVAL SPRAY PATTERNS AND VANELESS DESIGN

FullJet G and H Square Spray Nozzles

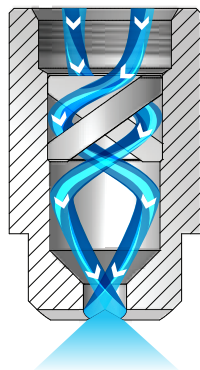

Square spray

As the liquid enters the nozzle, it flows over and through the vane. This creates the initial swirling of the liquid. The design of the nozzle ensures the liquid continues to swirl after passing through the vane. As the liquid exits the orifice, it interacts with cross cuts located on the face of the nozzle and forms a square spray pattern.

FullJet G-VL and GG-VL Nozzles

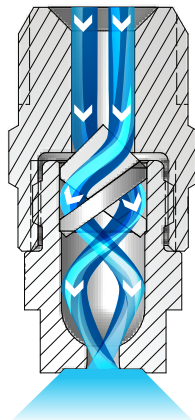

Oval spray

As the liquid enters the nozzle, it flows over and through the vane. This creates the initial swirling of the liquid. The design of the nozzle ensures the liquid continues to swirl after passing through the vane. The exit orifice of the nozzle has an oval shape. The liquid follows the oval shape as it exits the nozzle.

FullJet GANV and GGANV Nozzles

Vaneless spray

The liquid begins to swirl as it enters the swirlchamber. The swirling continues as it passes through the orifice. The breakup of the liquid occurs as it exits the nozzle orifice in a well-defined cone pattern.

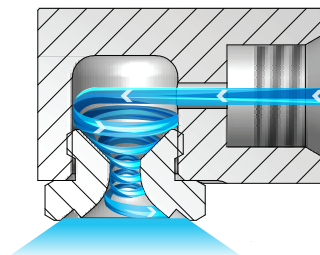

FULLJET SQUARE SPRAY PATTERN

- Cone-shaped spray pattern with square-like impact area for coverage of rectangular areas or spray zones
- Unique vane design and large flow passages provide superior spray pattern control
- Uniform spray distribution from .26 to 1977 gpm (1.1 to 7371 lpm)
- Operating pressures up to 150 psi (10 bar)
- Spray angles: Standard – 43° to 94°, Wide – 112° to 120°

S



G-SQ

1/8" to 1/2" female conn.
Removable cap and vane

S



W



H-SQ

1" female conn.
One-piece body

FULLJET SQUARE SPRAY OPTIONS

S



GG-SQ – 1/8" to 1/2" male conn.
Removable cap and vane

S



H-SQ – 1-1/4" to 6" female conn.
Removable vane/cast body

S



HH-SQ – 1/8" to 1" male conn.
One-piece body

W



H-WSQ – 3/4" to 1" female conn.
One-piece body

W



H-WSQ – 1-1/4" to 3" female conn.
Removable vane/cast body

W



HH-WSQ – 1/4" to 1" male conn.
One-piece body

FULLJET OVAL SPRAY PATTERN

- Solid cone-shaped spray pattern with oval impact area; the width of the spray is approximately half its length
- Unique vane design provides superior spray pattern control
- Uniform spray distribution from .59 to 3.2 gpm (2.2 to 11.9 lpm)
- Operating pressures up to 150 psi (10 bar)
- Spray angles: Standard – 43° to 94°



G-VL – 3/8" female conn.
Removable cap and vane



GG-VL – 3/8" female conn.
Removable cap and vane

FULLJET VANELESS DESIGN

- Solid cone-shaped spray pattern with round impact area
- Uniform spray distribution from .35 to 23 gpm (1.4 to 87 lpm)
- Operating pressures up to 100 psi (7 bar)
- No vane for unrestricted flow – coarse spray is projected at 90° from axis at the inlet
- Spray angles: Standard – 43° to 94°



GANV – 1/4" to 1/2" female conn.
Vaneless design
Removable cap



GGANV – 1/4" to 1/2" male conn.
Vaneless design
Removable cap

ORDERING INFORMATION

FULLJET SQUARE SPRAY PATTERN

Inlet Conn.	Nozzle Type	–	Material Code	Capacity Size	Example
					1/4 G – SS 12SQ

BSPT connections require the addition of a "B" prior to the inlet connection.

FULLJET OVAL SPRAY PATTERN

Inlet Conn.	Nozzle Type	–	Material Code	Capacity Size	Example
					3/8 G – SS 4.9VL

BSPT connections require the addition of a "B" prior to the inlet connection.

FULLJET VANELESS DESIGN

Inlet Conn.	Nozzle Type	–	Material Code	Capacity Size	Example
					1/4 GANV – SS 10

BSPT connections require the addition of a "B" prior to the inlet connection.

RELATIVE DROP SIZE IN MICRONS



Drop size will vary based on flow rate and pressure.

QUICK REFERENCE GUIDE

Model	Connection/ Type	Connection Size (in.)	Materials	Page Number	
				Performance Data	Dimensions and Weights
G-SQ	F	1/8 to 1/2	Brass, Mild steel (I), 303 stainless steel (SS), 316 stainless steel (316SS)	B32	B35
GG-SQ	M				
H-SQ	F	1	Brass, Mild steel (I), 303 stainless steel (SS)	B32	
H-SQ	F, Cast	1-1/4 to 6	Brass, 316 stainless steel (SS)	B33	
HH-SQ	M	1/8 to 1	Brass, Mild steel (I), 303 stainless steel (SS), 316 stainless steel (316SS), Polyvinyl chloride (PVC)	B32	
H-WSQ	F	3/4 to 1	Brass, Mild steel (I), 303 stainless steel (SS), 316 stainless steel (316SS)	B33	
H-WSQ	F, Cast	1-1/4 to 3	Brass, 316 stainless steel (SS)		
HH-WSQ	M	1/4 to 1	Brass, Mild steel (I), 303 stainless steel (SS), 316 stainless steel (316SS), Polyvinyl chloride (PVC)		
G-VL	F	3/8	Brass, 303 stainless steel (SS)	B34	
GG-VL	M				
GANV	F	1/4 to 1/2	Brass, 303 stainless steel (SS)		
GGANV	M				

F = female thread; M = male thread. There is no material code for brass. Leave material code blank when ordering. Other materials available upon request.
For more dimensions and sizes, contact your sales engineer.

S PERFORMANCE DATA:
STANDARD ANGLE SPRAY



Inlet Conn. (in.)	Nozzle Type				Capacity Size	Orifice Dia. Nom. (in.)	Max. Free Passage Dia. (in.)	Flow Rate Capacity (gallons per minute)								Spray Angle (°)		
	G-SQ	GG-SQ	HH-SQ	H-SQ				5 psi	7 psi	10 psi	20 psi	40 psi	80 psi	100 psi	150 psi	7 psi	20 psi	80 psi
1/8	●	●	●		3.6SQ	.063	.050	.26	.31	.36	.50	.68	.94	1.0	1.3	40	52	47
	●	●	●		4.8SQ	.078	.050	.35	.41	.48	.66	.91	1.2	1.4	1.7	48	63	57
	●	●	●		6SQ	.094	.050	.44	.51	.60	.83	1.1	1.6	1.7	2.1	60	66	60
1/4	●	●	●		10SQ	.109	.063	.73	.85	1.0	1.4	1.9	2.6	2.9	3.5	62	67	61
	●	●	●		12SQ	.125	.063	.87	1.0	1.2	1.7	2.3	3.1	3.5	4.2	70	75	68
			●		14.5SQ	.154	.063	1.1	1.2	1.5	2.0	2.7	3.8	4.2	5.0	78	82	75
3/8	●	●	●		18SQ	.156	.094	1.3	1.5	1.8	2.5	3.4	4.7	5.2	6.3	71	75	68
1/2	●	●	●		29SQ	.219	.125	2.1	2.5	2.9	4.0	5.5	7.5	8.4	10.1	71	75	68
			●		36SQ	.250	.125	2.6	3.1	3.6	5.0	6.8	9.4	10.4	12.5	78	82	75
3/4			●		50SQ	.266	.172	3.6	4.2	5.0	6.9	9.5	13.0	14.4	17.4	71	75	68
1			●	●	106SQ	.391	.219	7.7	9.0	10.6	14.6	20	28	31	37	78	80	73

Maximum Free Passage Diameter is the maximum diameter as listed of foreign matter that can pass through the nozzle without clogging.

Highlighted column shows the rated pressure.



S PERFORMANCE DATA:
STANDARD ANGLE SPRAY

Inlet Conn. (in.)	Nozzle Type				Capacity Size	Orifice Dia. Nom. (in.)	Max. Free Passage Dia. (in.)	Flow Rate Capacity (gallons per minute)								Spray Angle (°)		
	G-SQ	GG-SQ	HH-SQ	H-SQ				5 psi	7 psi	10 psi	20 psi	40 psi	80 psi	100 psi	150 psi	7 psi	20 psi	80 psi
1-1/4				●	177SQ	.500	.250	12.9	15.0	17.7	24	33	46	51	62	78	80	73
1-1/2				●	230SQ	.563	.344	16.7	19.5	23	32	44	60	66	80	73	77	70
2				●	290SQ	.609	.438	21	25	29	40	55	75	84	101	66	70	64
				●	360SQ	.687	.438	26	31	36	50	68	94	104	125	70	74	67
				●	480SQ	.828	.438	35	41	48	66	91	125	138	167	79	82	74
2-1/2				●	490SQ	.791	.563	36	42	49	67	93	128	141	170	62	67	61
				●	590SQ	.875	.563	43	50	59	81	112	154	170	205	75	78	71
				●	950SQ	1.125	.688	69	81	95	131	180	247	274	330	81	84	76
5				●	2980SQ	1.875	1.125	217	253	298	410	564	776	859	1036	89	91	83
6				●	5690SQ	3.219	1.750	414	483	569	783	1077	1481	1641	1977	102	105	95

Maximum Free Passage Diameter is the maximum diameter as listed of foreign matter that can pass through the nozzle without clogging.

Highlighted column shows the rated pressure.

W PERFORMANCE DATA:
WIDE ANGLE SPRAY



Inlet Conn. (in.)	Nozzle Type		Capacity Size	Orifice Dia. Nom. (in.)	Max. Free Passage Dia. (in.)	Flow Rate Capacity (gallons per minute)								Spray Angle (°)		
	H-WSQ	HH-WSQ				5 psi	7 psi	10 psi	15 psi	20 psi	40 psi	80 psi	5 psi	10 psi	80 psi	
1/4		●	14WSQ	.141	.063	1.0	1.2	1.4	1.7	1.9	2.6	3.5	99	101	93	
3/8		●	17WSQ	.156	.063	1.3	1.5	1.7	2.0	2.3	3.1	4.2	99	101	93	
		●	20WSQ	.172	.094	1.5	1.7	2.0	2.4	2.7	3.7	5.0	104	110	94	
		●	24WSQ	.188	.094	1.8	2.1	2.4	2.9	3.3	4.4	6.0	104	110	94	
		●	27WSQ	.203	.109	2.0	2.3	2.7	3.2	3.7	5.0	6.7	104	110	98	
1/2		●	30WSQ	.219	.109	2.2	2.6	3.0	3.6	4.1	5.5	7.5	104	110	102	
		●	35WSQ	.234	.125	2.6	3.0	3.5	4.2	4.7	6.4	8.7	104	110	102	
		●	40WSQ	.250	.125	2.9	3.4	4.0	4.8	5.4	7.4	10.0	104	110	102	
		●	45WSQ	.250	.141	3.3	3.8	4.5	5.4	6.1	8.3	11.2	104	110	102	
	●	50WSQ	.266	.156	3.7	4.3	5.0	6.0	6.8	9.2	12.5	104	110	102		
3/4	●	●	71WSQ	.391	.172	5.2	6.1	7.1	8.5	9.6	13.1	17.7	105	110	102	
1	●	●	130WSQ	.516	.219	9.6	11.1	13.0	15.5	17.6	24	32	107	110	107	
1-1/4	●		190WSQ	.609	.219	14.0	16.2	19.0	23	26	35	47	108	111	109	
1-1/2	●		290WSQ	.719	.313	21	25	29	35	39	53	72	109	114	109	
2	●		560WSQ	.984	.438	41	48	56	67	76	103	140	110	114	109	
2-1/2	●		830WSQ	1.250	.563	61	71	83	99	113	153	207	110	115	109	
3	●		1070WSQ	1.375	.688	79	91	107	128	145	197	267	110	115	109	

Maximum Free Passage Diameter is the maximum diameter as listed of foreign matter that can pass through the nozzle without clogging.

Highlighted column shows the rated pressure.



FULL
CONE

FULLJET® NOZZLES: SQUARE AND OVAL SPRAY PATTERNS AND VANELESS DESIGN

S STANDARD ANGLE SPRAY

S PERFORMANCE DATA:
STANDARD ANGLE SPRAY

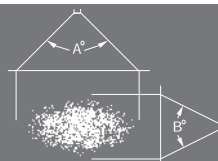

Inlet Conn. (in.)	Nozzle Type		Capacity Size	Max. Free Passage Dia. (in.)	Flow Rate Capacity (gallons per minute)							Spray Angle (°)							
					15 psi	30 psi	40 psi	60 psi	80 psi	100 psi	150 psi	15 psi		40 psi		100 psi		150 psi	
	G-VL	GG-VL			15 psi	30 psi	40 psi	60 psi	80 psi	100 psi	150 psi	A°	B°	A°	B°	A°	B°	A°	B°
3/8	●	●	4.9VL	.040	.59	.81	.93	1.1	1.3	1.4	1.7	104	66	90	60	86	52	83	47
	●	●	6.5VL	.050	.78	1.1	1.2	1.5	1.7	1.9	2.3	106	64	95	60	85	50	81	45
	●	●	8.1VL	.050	.98	1.3	1.5	1.8	2.1	2.3	2.8	102	64	100	65	84	50	80	45
	●	●	9.2VL	.050	1.1	1.5	1.7	2.1	2.4	2.7	3.2	103	65	100	65	86	51	81	46

Maximum Free Passage Diameter is the maximum diameter as listed of foreign matter that can pass through the nozzle without clogging.
Calibration pressure = 10 psi (0.7 bar).

S PERFORMANCE DATA:
STANDARD ANGLE SPRAY





Inlet Conn. (in.)	Nozzle Type		Capacity Size	Orifice Dia. Nom. (in.)	Max. Free Passage Dia. (in.)	Flow Rate Capacity (gallons per minute)								Spray Angle (°)		
	GANV	GGANV				5 psi	7 psi	10 psi	15 psi	20 psi	40 psi	80 psi	100 psi	7 psi	20 psi	80 psi
1/4	●	●	5	.109	.078	.35	.42	.50	.61	.71	1.0	1.4	1.6	68	75	82
	●	●	7	.125	.094	.49	.59	.70	.86	.99	1.4	2.0	2.2	68	75	82
	●	●	8	.156	.109	.57	.67	.80	.98	1.1	1.6	2.3	2.5	75	80	85
	●	●	10	.156	.125	.71	.84	1.0	1.2	1.4	2.0	2.8	3.2	75	80	85
	●	●	11	.156	.141	.78	.92	1.1	1.3	1.6	2.2	3.1	3.5	75	80	85
3/8	●	●	11	.172	.125	.78	.92	1.1	1.3	1.6	2.2	3.1	3.5	75	85	83
	●	●	13	.172	.141	.92	1.1	1.3	1.6	1.8	2.6	3.7	4.1	75	85	83
	●	●	16	.172	.156	1.1	1.3	1.6	2.0	2.3	3.2	4.5	5.1	75	85	83
	●	●	20	.219	.172	1.4	1.7	2.0	2.4	2.8	4.0	5.7	6.3	75	85	83
	●	●	23	.219	.188	1.6	1.9	2.3	2.8	3.3	4.6	6.5	7.3	75	85	83
	●	●	26	.234	.203	1.8	2.2	2.6	3.2	3.7	5.2	7.4	8.2	75	85	83
	●	●	29	.234	.219	2.1	2.4	2.9	3.6	4.1	5.8	8.2	9.2	75	85	83
1/2	●	●	33	.297	.234	2.3	2.8	3.3	4.0	4.7	6.6	9.3	10.4	75	85	83
	●	●	32	.313	.203	2.3	2.7	3.2	3.9	4.5	6.4	9.1	10.1	85	90	95
	●	●	40	.313	.234	2.8	3.3	4.0	4.9	5.7	8.0	11.3	12.6	85	90	95
	●	●	48	.313	.281	3.4	4.0	4.8	5.9	6.8	9.6	13.6	15.2	85	90	95
	●	●	56	.391	.297	4.0	4.7	5.6	6.9	7.9	11.2	15.8	17.7	85	90	95
	●	●	64	.391	.328	4.5	5.4	6.4	7.8	9.1	12.8	18.1	20	85	90	95
	●	●	72	.391	.359	5.1	6.0	7.2	8.8	10.2	14.4	20	23	85	90	95

Maximum Free Passage Diameter is the maximum diameter as listed of foreign matter that can pass through the nozzle without clogging.

Highlighted column shows the rated pressure.

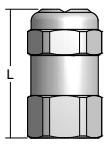
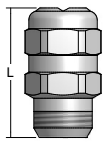
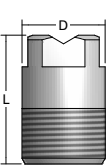
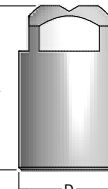

DIMENSIONS AND WEIGHTS

Nozzle	Nozzle Type	Inlet Conn. (in.)	L (in.)	Hex. (in.)	D (Dia.) (in.)	Net Weight (oz.)
	G-SQ (F)	1/8	1.124	9/16	–	0.9
		1/4	1.342	11/16	–	1.6
	GG-SQ (M)	1/8	1.187	9/16	–	0.1
		1/4	1.436	11/16	–	0.1
	HH-SQ (M)	1/8	0.875	–	0.500	0.5
		1/4	0.875	–	0.531	0.5
		3/8	0.938	–	0.656	0.8
		1/2	1.131	–	0.813	1.7
		3/4	1.531	–	1.063	3.6
		1	2.031	–	1.313	1.4
	H-SQ (F)	1	2.688	–	1.500	13.2
	H-SQ (F) Cast	1-1/4	2.688	1-7/8 oct.	–	16.9
		1-1/2	4.000	2-1/8 oct.	–	25.4
		2	5.000	2-5/8 oct.	–	41.4
		2-1/2	6.156	3-1/8 oct.	–	80.5
		5	12.250	6-3/4 oct.	–	38
		6	14.375	8 oct.	–	53

Based on the largest/heaviest version of each type.

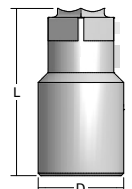
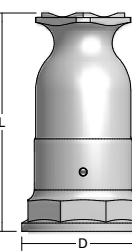
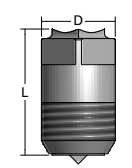
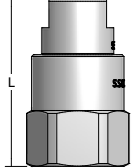
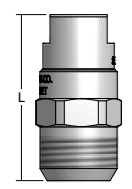
Nozzle	Nozzle Type	Inlet Conn. (in.)	L (in.)	Hex. (in.)	D (Dia.) (in.)	Net Weight (oz.)
	H-WSQ (F)	3/4	1.594	–	1.250	3.6
		1	2.078	–	1.500	6.5
	H-WSQ (F) Cast	1-1/4	3.375	–	2.063	14
		1-1/2	4.000	–	2.313	24.6
		2	5.000	–	3.000	45.2
		2-1/2	6.156	–	3.438	72.8
		3	7.344	–	4.063	106.5
	HH-WSQ (M)	1/4	0.906	–	0.531	0.5
		3/8	1.188	–	0.656	1.1
		1/2	1.375	–	0.813	1.8
		3/4	1.594	–	1.063	3.5
		1	2.078	–	1.313	7.0
	G-VL (F)	3/8	1.500	13/16	2.250	2.3
	GG-VL (M)	3/8	1.500	13/16	2.250	1.9

Based on the largest/heaviest version of each type.

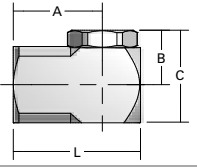
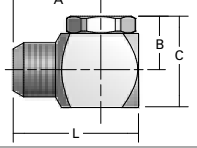
Nozzle	Nozzle Type	Inlet Conn. (in.)	L (in.)	A (in.)	B (in.)	C (in.)	Net Weight (oz.)
	GANV (F)	1/4	1.250	0.875	0.535	0.909	2
		3/8	1.406	0.969	0.629	1.066	3.3
		1/2	1.812	1.312	0.756	1.256	6.3
	GGANV (M)	1/4	1.250	0.875	0.535	0.910	2
		3/8	1.406	0.969	0.629	1.066	3.3
		1/2	1.875	1.375	0.756	1.256	6.3

Based on the largest/heaviest version of each type.



OVERVIEW: UNIJET

- Quick-connect nozzles reduce maintenance time – bodies remain on pipe/header
- Save on nozzle replacement costs – bodies can be reused, only spray tips are replaced; tips fit on male or female bodies
- Solid cone-shaped spray pattern with round impact area or cone-shaped spray pattern with square-like impact area for coverage of rectangular areas or spray zones
- Spray angles: Standard – 43° to 91°, Wide – 112° to 120°
- Uniform spray distribution from .08 to 7.4 gpm (.3 to 28 lpm)
- Operating pressures up to 300 psi (20 bar)

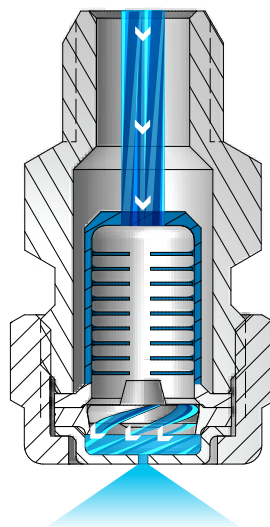

UniJet D and TG Nozzles

As the liquid enters the nozzle, it passes through an internal strainer and into the slotted core where the swirling begins. The swirling continues as the liquid passes through a disc. The breakup of the liquid occurs as it exits the orifice, producing a well-defined cone pattern. The drops are uniform in size and distributed equally throughout the spray pattern.

UNIJET OPTIONS

S

Tip Retainer

D Disc

Core

Strainer

T Body

D Spray Tip + T Body
1/4" female conn.
Disc and core type
Use with slotted strainer and tip retainer

TG-SQ Spray Tip + T Body
Use with T or TT bodies and tip retainer

TT Body/Cap
1/8" to 1/2" male conn.

T Body/Cap
1/8" to 1/2" female conn.

S

TG Spray Tip
Use with T or TT bodies and tip retainer

W

TG-W Spray Tip
Use with T or TT bodies and tip retainer

S

TG-SQ Spray Tip
Use with T or TT bodies and tip retainer

W

TH-W Spray Tip
Tip and retainer in one
Use with T or TT bodies

ORDERING INFORMATION

UNIJET

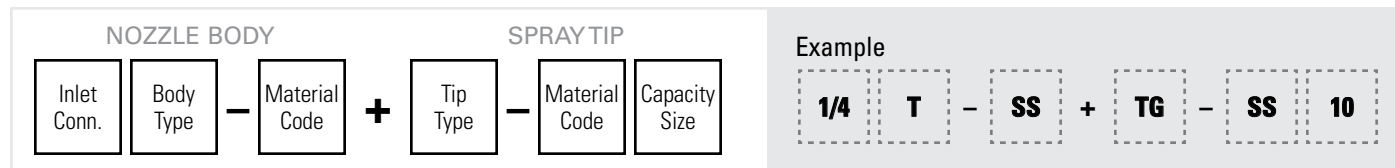

UniJet nozzle assemblies include a pre-sized wire mesh based on orifice diameter. When ordering just a UniJet spray tip, the mesh is not included. See Accessories, page F6 for a mesh selection guide and ordering information.

BSPT connections require the addition of a "B" prior to the nozzle body inlet connection.

UNIJET – DISC AND CORE TYPE

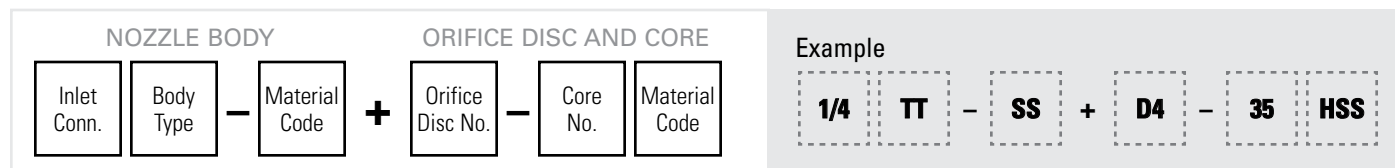

UniJet nozzle assemblies include a pre-sized wire mesh based on orifice diameter. When ordering just a UniJet spray tip, the mesh is not included. See Accessories, page F6 for a mesh selection guide and ordering information.

BSPT connections require the addition of a "B" prior to the nozzle body inlet connection.

QUICK REFERENCE GUIDE

Model	Connection	Connection Size (in.)	Materials	Page Number	
				Performance Data	Dimensions and Weights
T body	F	1/8 to 1/2	Brass, 303 stainless steel (SS)	–	B40
TT body	M			–	
D spray tip	NA	NA	303 stainless steel (SS), Hardened stainless steel (HSS)	B38	
TG spray tip	NA	NA	Brass, 303 stainless steel (SS)	B39	
TG-W and TH-W spray tips	NA	NA	Brass, 303 stainless steel (SS)	B39	
TG-SQ spray tip	NA	NA	Brass, 303 stainless steel (SS)	B40	

F = female thread; M = male thread; NA = not applicable. There is no material code for brass. Leave material code blank when ordering. Other materials available upon request. For more dimensions and sizes, contact your sales engineer.

**RELATIVE DROP SIZE
IN MICRONS**



Drop size will vary based on flow rate and pressure.

S PERFORMANCE DATA:
STANDARD ANGLE SPRAY

Body Inlet Conn. (in.)	UniJet Tip Type	Orifice Disc No. – Core No.	Orifice Dia. Nom. (in.)	Flow Rate Capacity (gallons per minute)									Spray Angle (°)		
				10 psi	20 psi	40 psi	80 psi	100 psi	150 psi	200 psi	300 psi	20 psi	40 psi	80 psi	
1/4	●	D1-31	.031	.08	.11	.15	.20	.23	.27	.31	.37	49	47	43	
	●	D1.5-31	.036	.10	.14	.19	.26	.29	.35	.40	.48	57	65	53	
	●	D2-31	.041	.12	.16	.22	.30	.33	.40	.45	.55	62	63	61	
	●	D3-31	.047	.13	.18	.24	.33	.37	.44	.50	.60	63	65	63	
	●	D1-33	.031	.09	.11	.14	.20	.22	.26	.30	.37	27	32	35	
	●	D1.5-33	.036	.12	.15	.19	.26	.30	.36	.41	.50	37	43	45	
	●	D2-33	.041	.13	.17	.24	.33	.37	.45	.52	.63	45	52	55	
	●	D3-33	.047	.15	.21	.29	.41	.45	.55	.63	.76	48	54	57	
	●	D4-33	.063	.20	.28	.39	.54	.60	.73	.83	1.02	50	56	61	
	●	D1-35	.031	.08	.11	.14	.20	.22	.26	.29	.35	19	23	26	
	●	D1.5-35	.036	.10	.14	.19	.26	.29	.34	.39	.46	23	27	29	
	●	D2-35	.041	.14	.18	.25	.34	.37	.45	.51	.60	40	44	47	
	●	D3-35	.047	.16	.22	.30	.41	.45	.55	.62	.74	45	50	52	
	●	D4-35	.063	.27	.37	.50	.70	.79	.93	1.1	1.3	68	70	71	
	●	D5-35	.078	.34	.48	.66	.92	1.0	1.2	1.4	1.7	67	69	71	
	●	D2-56	.041	–	–	.25	.35	.39	.47	.55	.67	–	14	17	
	●	D3-56	.047	–	–	.34	.48	.53	.65	.75	.92	–	20	23	
	●	D4-56	.063	–	.39	.55	.78	.87	1.1	1.2	1.5	20	26	29	
	●	D5-56	.078	.38	.54	.76	1.1	1.2	1.5	1.7	2.1	26	32	34	
	●	D6-56	.094	.55	.78	1.1	1.6	1.7	2.1	2.5	3.0	34	39	41	
●	D7-56	.109	.76	1.1	1.5	2.2	2.4	2.9	3.4	4.2	45	52	54		
●	D8-56	.125	.96	1.4	1.9	2.7	3.1	3.7	4.3	5.3	52	57	59		
●	D10-56	.156	1.4	1.9	2.7	3.8	4.3	5.2	6.0	7.4	62	65	67		

For nozzles using Orifice Disc Nos. 1, 1.5 and 2 or Core Nos. 31 and 33, Slotted Strainer No. 4514-20 equivalent to 25 mesh screen size is supplied. For all other larger capacity Discs and Cores, Slotted Strainer No. 4514-32 equivalent to 16 mesh screen size is supplied.

Other body sizes may be available. Contact your sales engineer for further information.

For additional information see Data Sheet 4498-1.

Highlighted column shows the rated pressure.



S PERFORMANCE DATA:
STANDARD ANGLE SPRAY

Body Inlet Conn. (in.)	UniJet Tip Type		Capacity Size	Orifice Dia. Nom. (in.)	Max. Free Passage Dia. (in.)	Flow Rate Capacity (gallons per minute)							Spray Angle (°)			
	TG					5 psi	7 psi	10 psi	20 psi	40 psi	80 psi	100 psi	150 psi	7 psi	20 psi	80 psi
1/4	●		.3	.020	.016	–	–	–	.041	.057	.078	.087	.10	–	50	61
	●		.4	.022	.018	–	–	–	.055	.076	.10	.12	.14	–	56	63
	●		.5	.024	.020	–	–	–	.069	.095	.13	.14	.17	–	56	63
	●		.6	.027	.020	–	–	–	.083	.11	.16	.17	.21	–	54	62
	●		.7	.030	.020	–	–	–	.096	.13	.18	.20	.24	–	54	63
	●		1	.036	.025	–	–	.10	.14	.19	.26	.29	.35	–	58	53
	●		2	.047	.040	.15	.17	.20	.28	.38	.52	.58	.70	43	50	46
	●		3	.062	.040	.22	.25	.30	.41	.57	.78	.87	1.0	52	65	59
	●		3.5	.067	.050	.25	.30	.35	.48	.66	.91	1.0	1.2	43	50	46
	●		5	.082	.050	.36	.42	.50	.69	.95	1.3	1.4	1.7	52	65	59
	●		6.5	.094	.063	.47	.55	.65	.89	1.2	1.7	1.9	2.3	45	50	46
●		10	.109	.063	.73	.85	1.0	1.4	1.9	2.6	2.9	3.5	58	67	61	

Maximum Free Passage Diameter is the maximum diameter as listed of foreign matter that can pass through the nozzle without clogging.

Other body sizes may be available. Contact your sales engineer for further information.

Highlighted column shows the rated pressure.

W PERFORMANCE DATA:
WIDE ANGLE SPRAY

Body Inlet Conn. (in.)	UniJet Tip Type		Capacity Size	Orifice Dia. Nom. (in.)	Max. Free Passage Dia. (in.)	Flow Rate Capacity (gallons per minute)							Spray Angle (°)		
	TG-W	TH-W				5 psi	7 psi	10 psi	15 psi	20 psi	40 psi	80 psi	5 psi	10 psi	80 psi
1/8, 1/4	●	●	2.8W	.063	.040	–	–	.28	.34	.39	.53	.73	–	120	102
	●	●	4.3W	.078	.040	–	–	.43	.52	.59	.81	1.1	–	120	102
	●	●	5.6W	.094	.040	–	.48	.56	.67	.77	1.1	1.5	–	120	102
	●	●	8W	.094	.050	–	.68	.80	.96	1.1	1.5	2.1	–	120	103
1/4	●	●	10W	.109	.050	.73	.85	1.0	1.2	1.4	1.9	2.6	112	120	103
	●		12W	.125	.050	.87	1.0	1.2	1.4	1.7	2.3	3.1	114	120	103
	●	●	14W	.141	.063	1.0	1.2	1.4	1.7	1.9	2.6	3.6	114	120	103
3/8		●	17W	.156	.063	1.2	1.4	1.7	2.0	2.3	3.2	4.4	114	120	103
		●	20W	.172	.094	1.5	1.7	2.0	2.4	2.8	3.8	5.2	114	120	104
		●	24W	.188	.094	1.7	2.0	2.4	2.9	3.3	4.5	6.2	114	120	104
		●	27W	.203	.109	2.0	2.3	2.7	3.3	3.7	5.1	7.0	114	120	106
1/2		●	30W	.219	.109	2.2	2.5	3.0	3.6	4.1	5.7	7.8	114	120	108
		●	35W	.234	.125	2.5	3.0	3.5	4.2	4.8	6.6	9.1	114	120	108

Maximum Free Passage Diameter is the maximum diameter as listed of foreign matter that can pass through the nozzle without clogging.

Other body sizes may be available. Contact your sales engineer for further information.

Highlighted column shows the rated pressure.



S PERFORMANCE DATA:
STANDARD ANGLE SPRAY

Body Inlet Conn. (in.)	UniJet Tip Type	Capacity Size	Orifice Dia. Nom. (in.)	Max. Free Passage Dia. (in.)	Flow Rate Capacity (gallons per minute)								Spray Angle (°)		
					5 psi	7 psi	10 psi	20 psi	40 psi	80 psi	100 psi	150 psi	7 psi	20 psi	80 psi
1/4	●	6SQ	.094	.050	.44	.51	.60	.83	1.1	1.6	1.7	2.1	60	66	60
	●	8SQ	.099	.050	.58	.68	.80	1.1	1.5	2.1	2.3	2.8	70	75	68
	●	10SQ	.109	.063	.73	.85	1.0	1.4	1.9	2.6	2.9	3.5	62	66	60
	●	12SQ	.125	.063	.87	1.0	1.2	1.7	2.3	3.1	3.5	4.2	70	75	68
3/8	●	18SQ	.156	.094	1.3	1.5	1.8	2.5	3.4	4.7	5.2	6.3	71	75	68

Maximum Free Passage Diameter is the maximum diameter as listed of foreign matter that can pass through the nozzle without clogging.

Other body sizes may be available. Contact your sales engineer for further information.

Highlighted column shows the rated pressure.

DIMENSIONS AND WEIGHTS

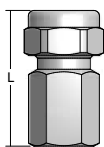
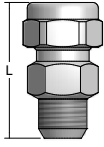
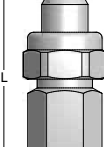
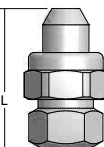
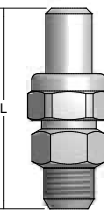
Nozzle	Nozzle Type	Inlet Conn. (in.)	L (in.)	Hex. (in.)	Net Weight (oz.)
	T (F) + D	1/4	1.500	13/16	2.1
	TT (M) + D	1/4	1.500	13/16	1.9
	T (F) + TG	1/4	1.844	13/16	2.3
	TT (M) + TG	1/4	1.844	13/16	2.1
	T (F) + TG-W TT (M) + TG-W	1/8	2.078	13/16	2.1
		1/4	2.078	13/16	2.3

Based on the largest/heaviest version of each type. Additional sizes are available.

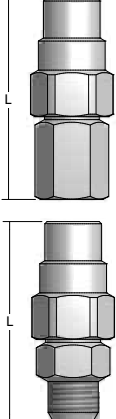
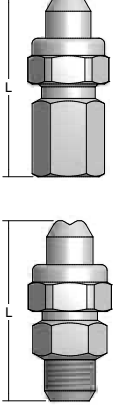
Nozzle	Nozzle Type	Inlet Conn. (in.)	L (in.)	Hex. (in.)	Net Weight (oz.)
	T (F) + TH-W TT (M) + TH-W	1/8	2.157	13/16	3.8
		1/4	2.673	13/16	3.7
		3/8	2.679	13/16	4.1
		1/2	2.610	1	4.3
	T (F) + TG-SQ TT (M) + TG-SQ	1/4	2.281	13/16	1.7
		3/8	2.288	13/16	2.1

Based on the largest/heaviest version of each type. Additional sizes are available.





FLAT SPRAY NOZZLES

PRESSURE WASHING · CLEANING
RINSING · COOLING · COATING
WASHDOWN · PARTS WASHING
DEGREASING · MOISTENING
SURFACE PREPARATION
SNOWMAKING



FLAT SPRAY NOZZLES
INTRODUCTION



MORE SIZES AND OPTIONS THAN ANY OTHER SUPPLIER

Styles:

- Conventional
- Quick-connect

Spray patterns:

- Standard
- Wide angle
- Narrow angle

Spray angles: 0° (solid stream) to 170°

Flow rate range: .003 to 1237 gpm (.013 to 4720 lpm)

Operating pressure range: up to 4000 psi (275 bar)

Connections:

- 1/8" to 2" pipe sizes
- Female and male NPT and BSPT

Materials:

- Brass
- Mild steel
- 303 stainless steel
- 316 stainless steel
- 400 series stainless steel
- Polyvinyl chloride
- Hardened stainless steel
- ProMax®
- Other specialty materials available

See Trademark Registration and Ownership, page i-1.

OPTIMIZE THE PERFORMANCE OF VEEJET® NOZZLES:

Accurately control spray line pressure with piston-type **pressure relief valves**. Minimize liquid waste caused by excessive pressure by bypassing excess liquid back to the liquid source or pump inlet.

See page F31



Use **adjustable ball fittings** for quick positioning of spray tips. Tips can be adjusted within a 50° included angle. Locking screws maintain nozzle position even when jarred or subject to vibration.

See page F23



Minimize clogging in UniJet® nozzles by trapping larger particles and preventing debris from entering the orifice by using **strainers**. Available in a wide range of materials and mesh sizes.

See page F16



**FLAT SPRAY NOZZLES
TABLE OF CONTENTS**

**VEEJET® NOZZLES:
STANDARD ANGLE SPRAY**

	PAGE
H-DT, H-DU, H-U, H-VV, H-VVL and U nozzles	C4
Quick Reference Guide	C5

**QUICK VEEJET® AND PROMAX® QUICK VEEJET NOZZLES:
STANDARD ANGLE SPRAY**

	PAGE
QJJS miniature Quick VeeJet body	C14
QSVV miniature Quick VeeJet spray tips	C14
QJA, QJLA, QJJA and QJJLA Quick VeeJet bodies	C14
QLUA, QUA and QVVA Quick VeeJet spray tips	C14
QPPM ProMax miniature Quick VeeJet body	C15
QMVV ProMax miniature Quick VeeJet spray tips	C15
QPPA ProMax Quick VeeJet body	C15
QPTA ProMax Quick VeeJet spray tips	C15
Quick Reference Guide	C16

**UNIJET® NOZZLES:
STANDARD ANGLE SPRAY**

	PAGE
T and TT UniJet bodies	C24
TPU and 13802 UniJet spray tips	C24
Quick Reference Guide	C25

**WASHJET® NOZZLES:
HIGH IMPACT STANDARD ANGLE SPRAY**

	PAGE
MEG, WEG, MEG-SSTC, IMEG® nozzles	C32
QCMEG and QCIMEG™ nozzles	C33
Quick Reference Guide	C34

**UNIJET® NOZZLES:
HIGH PRESSURE STANDARD ANGLE SPRAY**

	PAGE
11430 UniJet body	C38
EG UniJet spray tips	C38
Quick Reference Guide	C39

**FLOODJET® NOZZLES:
WIDE ANGLE SPRAY**

	PAGE
K nozzles	C40
TEK nozzles	C40
QJA and QJJA Quick FloodJet bodies	C41
QTKA Quick FloodJet spray tips	C41
QJJS miniature Quick FloodJet body	C41
QSTK miniature Quick FloodJet spray tips	C41
T and TT UniJet bodies	C42
TK UniJet FloodJet spray tips	C42
Quick Reference Guide	C43

**FLATJET® NOZZLES:
NARROW ANGLE SPRAY**

	PAGE
P nozzles	C47
Quick Reference Guide	C48

**ULTRA-HIGH PRESSURE NOZZLES:
STANDARD ANGLE SPRAY**

	PAGE
VS625 nozzles	C50
VS940 nozzles	C50
FS and VS spray tips	C50
58833 and 58834 bodies	C50
Quick Reference Guide	C51



**FLAT
SPRAY**

VEEJET® NOZZLES

S STANDARD ANGLE SPRAY

OVERVIEW: VEEJET H AND U

- Flat spray nozzles are ideal for use in spray headers or manifolds. They produce a fan-type, tapered-edge spray pattern to ensure even coverage when multiple nozzles are used in a series
- Solid stream (0° spray angle) available to achieve highest impact of any nozzle type
- Consistent performance over the industry's largest range of flow rates and pressures
- Some models feature an integral strainer
- High pressure/high impact versions available
- Quick-connect versions available to speed maintenance and installation

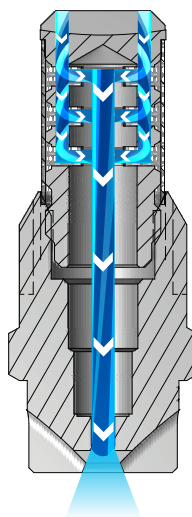

VeeJet H and U Nozzles

As the liquid exits through the sharp V shape cut of the orifice, it forms into a flat spray pattern. The distribution is tapered from the center of the spray.

VEEJET H AND U NOZZLES

- Flat fan type, tapered edge spray pattern
- One-piece design
- Spray angles from 0° to 110°
- Uniform spray distribution with flow rates from .012 to 1237 gpm (.047 to 4720 lpm)
- Operating pressures up to 500 psi (35 bar)

S



H-U

1/8" to 3/4" male conn.

Flow rates of 1 gpm and greater at 40 psi
(3.8 lpm and greater at 2.8 bar)

S



H-VV and H-VVL

1/8" to 1/4" male conn.

Flow rates below 1 gpm at 40 psi
(3.8 lpm at 2.8 bar)
H-VVL includes integral strainer

S



VEEJET H AND U OPTIONS

S



H-DT

1/8" to 1/4" female conn.
Flow rates below 1 gpm at 40 psi
(3.8 lpm at 2.8 bar)

S



H-DU

1/8" to 1/4" female conn.
Flow rates of 1 gpm and greater at 40 psi
(3.8 lpm and greater at 2.8 bar)

S



U

1" to 2" male conn.
Flow rates of 40 gpm and greater at 40 psi
(151 lpm and greater at 2.8 bar)

**RELATIVE DROP SIZE
IN MICRONS**



10 to 100



100 to 500



500 to 1000



1000 to 5000

Drop size will vary based on flow rate and pressure.



ORDERING INFORMATION

VEEJET H-DT, H-DU, H-U, H-VV AND H-VVL

Nozzle Prefix	Inlet Conn.	Nozzle Type	-	Material Code	Spray Angle	Capacity Size
---------------	-------------	-------------	---	---------------	-------------	---------------

Example

H	1/4	VV	-	SS	110	10
---	-----	----	---	----	-----	----

BSPT connections require the addition of a "B" prior to the inlet connection.

VEEJET U

Inlet Conn.	Nozzle Type	-	Material Code	Spray Angle	Capacity Size
-------------	-------------	---	---------------	-------------	---------------

Example

1	U	-	SS	50	500
---	---	---	----	----	-----

BSPT connections require the addition of a "B" prior to the inlet connection.

QUICK REFERENCE GUIDE

Model	Connection	Connection Size (in.)	Materials	Page Number	
				Performance Data	Dimensions and Weights
H-DT	F	1/8 to 1/4	Brass, 303 stainless steel (SS)	C6-C8	C13
H-DU	F	1/8 to 1/4	Brass, 303 stainless steel (SS), Polyvinyl chloride (PVC)	C9-C13	
H-U	M	1/8 to 3/4	Brass, Mild steel (I), 303 stainless steel (SS), 316 stainless steel (316SS), Polyvinyl chloride (PVC)	C9-C13	
H-VV	M	1/8 to 1/4	Brass, Mild steel (I), 303 stainless steel (SS), 316 stainless steel (316SS)	C6-C8	
H-VVL	M	1/8 to 1/4	Brass, 303 stainless steel (SS), 316 stainless steel (316SS)	C6-C8	
U	M	1 to 2	Brass, Mild steel (I), 303 stainless steel (SS)	C9-C13	

F = female thread; M = male thread. There is no material code for brass. Leave material code blank when ordering. Other materials available upon request. For more dimensions and sizes, contact your sales engineer.



FLAT
SPRAY

VEEJET® NOZZLES

S STANDARD ANGLE SPRAY

S PERFORMANCE DATA:
STANDARD ANGLE SPRAY



Spray Angle at 40 psi	Nozzle Type/ Inlet Conn. (in.)						Capacity Size	Equiv. Orifice Dia. (in.)	Flow Rate Capacity (gallons per minute)										Spray Angle (°)			
	H-VV		H-VVL		H-DT				5 psi	10 psi	20 psi	40 psi	80 psi	100 psi	200 psi	300 psi	500 psi	20 psi	40 psi	80 psi	200 psi	
	1/8	1/4	1/8	1/4	1/8	1/4																
110°	•	•	•	•			01	.026	.035	.05	.07	.10	.14	.16	.22	.27	.35	94	110	121	124	
	•	•	•	•			015	.032	.05	.08	.11	.15	.21	.24	.34	.41	.53	97	110	121	124	
	•	•	•	•		•	02	.035	.07	.10	.14	.20	.28	.32	.45	.55	.71	98	110	120	123	
	•	•	•	•		•	03	.043	.11	.15	.21	.30	.42	.47	.67	.82	1.1	99	110	120	123	
	•	•	•	•	•	•	04	.050	.14	.20	.28	.40	.57	.63	.89	1.1	1.4	100	110	119	122	
	•	•	•	•		•	05	.056	.18	.25	.35	.50	.71	.79	1.1	1.4	1.8	100	110	118	122	
	•	•	•	•	•	•	06	.061	.21	.30	.42	.60	.85	.95	1.3	1.6	2.1	101	110	117	122	
	•	•	•	•		•	08	.071	.28	.40	.57	.80	1.1	1.3	1.8	2.2	2.8	102	110	117	121	
	•	•	•	•	•	•	10	.079	.35	.50	.71	1.0	1.4	1.6	2.2	2.7	3.5	103	110	117	119	
	•	•	•	•		•	15	.094	.53	.75	1.1	1.5	2.1	2.4	3.4	4.1	5.3	104	110	117	118	
95°	•		•		•		0050	.018	–	–	.035	.050	.07	.08	.11	.14	.18	81	95	105	113	
	•	•	•	•			01	.026	.035	.05	.07	.10	.14	.16	.22	.27	.35	81	95	105	113	
	•		•	•			015	.032	.05	.08	.11	.15	.21	.24	.34	.41	.53	82	95	105	113	
	•	•	•	•	•	•	02	.035	.07	.10	.14	.20	.28	.32	.45	.55	.71	82	95	105	113	
	•	•	•	•		•	03	.043	.11	.15	.21	.30	.42	.47	.67	.82	1.1	83	95	104	111	
	•	•	•	•	•	•	04	.050	.14	.20	.28	.40	.57	.63	.89	1.1	1.4	84	95	103	108	
	•	•	•	•	•		05	.056	.18	.25	.35	.50	.71	.79	1.1	1.4	1.8	84	95	102	107	
	•	•	•	•	•	•	06	.061	.21	.30	.42	.60	.85	.95	1.3	1.6	2.1	86	95	101	106	
	•				•		065	.064	.23	.33	.46	.65	.92	1.0	1.5	1.8	2.3	86	95	101	106	
	•	•	•	•	•	•	08	.071	.28	.40	.57	.80	1.1	1.3	1.8	2.2	2.8	87	95	100	105	
80°	•	•	•	•			0050	.018	–	–	.035	.050	.07	.08	.11	.14	.18	61	80	95	101	
	•	•	•	•			0067	.021	–	.033	.05	.067	.09	.11	.15	.18	.24	67	80	94	99	
	•	•	•	•	•	•	01	.026	–	.05	.07	.10	.14	.16	.22	.27	.35	68	80	89	92	
		•	•	•		•	015	.032	–	.08	.11	.15	.21	.24	.34	.41	.53	68	80	89	92	
	•	•	•	•	•	•	02	.035	.07	.10	.14	.20	.28	.32	.45	.55	.71	69	80	88	91	
	•	•	•	•	•	•	03	.043	.11	.15	.21	.30	.42	.47	.67	.82	1.1	70	80	87	90	
	•	•	•	•	•	•	04	.050	.14	.20	.28	.40	.57	.63	.89	1.1	1.4	71	80	86	89	
	•	•	•	•	•	•	05	.056	.18	.25	.35	.50	.71	.79	1.1	1.4	1.8	71	80	86	89	
	•	•	•	•	•	•	06	.061	.21	.30	.42	.60	.85	.95	1.3	1.6	2.1	72	80	85	88	
	•				•	•	07	.066	.25	.35	.49	.70	.99	1.1	1.6	1.9	2.5	72	80	85	88	
	•	•	•	•	•	•	08	.071	.28	.40	.57	.80	1.1	1.3	1.8	2.2	2.8	72	80	84	87	
		•		•	•	•	09	.075	.32	.45	.64	.90	1.3	1.4	2.0	2.5	3.2	73	80	84	87	

Highlighted column shows the rated pressure.

S PERFORMANCE DATA:
STANDARD ANGLE SPRAY

Spray Angle at 40 psi	Nozzle Type/ Inlet Conn. (in.)						Capacity Size	Equiv. Orifice Dia. (in.)	Flow Rate Capacity (gallons per minute)										Spray Angle (°)			
	H-VV		H-VVL		H-DT				5 psi	10 psi	20 psi	40 psi	80 psi	100 psi	200 psi	300 psi	500 psi	20 psi	40 psi	80 psi	200 psi	
	1/8	1/4	1/8	1/4	1/8	1/4																
73°	•	•	•	•	•		0077	.023	–	.039	.055	.077	.11	.12	.17	.21	.27	53	73	86	92	
	•	•	•	•			0154	.032	.054	.077	.11	.15	.22	.24	.34	.42	.54	55	73	84	88	
		•		•			0231	.038	.082	.12	.16	.23	.33	.37	.52	.63	.82	56	73	83	87	
	•	•	•	•			0308	.044	.11	.15	.22	.31	.44	.49	.69	.84	1.1	58	73	82	86	
		•		•			0462	.054	.16	.23	.33	.46	.65	.73	1.0	1.3	1.6	60	73	80	84	
	•		•				0770	.069	.27	.39	.54	.77	1.1	1.2	1.7	2.1	2.7	64	73	77	82	
65°	•		•				0017	.011	–	–	.012	.017	.024	.027	.038	.047	.06	44	65	77	86	
	•		•				0033	.015	–	–	.023	.033	.047	.052	.07	.09	.12	47	65	76	83	
	•	•	•	•	•		0067	.021	–	.033	.05	.067	.09	.11	.15	.18	.24	50	65	75	81	
	•	•	•	•	•	•	01	.026	–	.05	.07	.10	.14	.16	.22	.27	.35	51	65	74	80	
	•	•	•	•			015	.032	–	.08	.11	.15	.21	.24	.34	.41	.53	51	65	74	80	
	•	•	•	•	•	•	02	.035	.07	.10	.14	.20	.28	.32	.45	.55	.71	52	65	73	79	
	•		•				025	.039	.09	.13	.18	.25	.35	.40	.56	.68	.88	52	65	73	79	
	•	•	•	•	•	•	03	.043	.11	.15	.21	.30	.42	.47	.67	.82	1.1	53	65	72	78	
	•	•	•	•	•	•	04	.050	.14	.20	.28	.40	.57	.63	.89	1.1	1.4	53	65	72	76	
	•	•	•	•	•	•	05	.056	.18	.25	.35	.50	.71	.79	1.1	1.4	1.8	53	65	72	76	
		•			•	•	055	.059	.19	.28	.39	.55	.78	.87	1.2	1.5	1.9	53	65	72	76	
	•	•		•	•	•	06	.061	.21	.30	.42	.60	.85	.95	1.3	1.6	2.1	54	65	72	75	
		•			•	•	07	.066	.25	.35	.49	.70	.99	1.1	1.6	1.9	2.5	54	65	71	75	
	•	•	•	•	•	•	08	.071	.28	.40	.57	.80	1.1	1.3	1.8	2.2	2.8	55	65	71	74	
	•				•	•	09	.075	.32	.45	.64	.90	1.3	1.4	2.0	2.5	3.2	55	65	71	74	
	50°	•	•	•	•			01	.026	–	.05	.07	.10	.14	.16	.22	.27	.35	37	50	59	65
•		•	•	•			02	.035	–	.10	.14	.20	.28	.32	.45	.55	.71	39	50	57	63	
•		•	•	•		•	03	.043	.11	.15	.21	.30	.42	.47	.67	.82	1.1	40	50	56	62	
•		•	•	•		•	04	.050	.14	.20	.28	.40	.57	.63	.89	1.1	1.4	42	50	56	61	
•		•	•	•		•	05	.056	.18	.25	.35	.50	.71	.79	1.1	1.4	1.8	44	50	56	61	
•						•	055	.059	.19	.28	.39	.55	.78	.87	1.2	1.5	1.9	44	50	56	61	
•		•	•	•		•	06	.061	.21	.30	.42	.60	.85	.95	1.3	1.6	2.1	45	50	56	60	
•		•				•	07	.066	.25	.35	.49	.70	.99	1.1	1.6	1.9	2.5	45	50	56	60	
•		•	•	•		•	08	.071	.28	.40	.57	.80	1.1	1.3	1.8	2.2	2.8	45	50	55	60	
		•			•	•	09	.075	.32	.45	.64	.90	1.3	1.4	2.0	2.5	3.2	45	50	55	59	
40°	•	•	•	•	•		01	.026	–	–	.07	.10	.14	.16	.22	.27	.35	26	40	52	59	
	•	•	•	•	•		015	.032	–	–	.11	.15	.21	.24	.34	.41	.53	27	40	52	59	
	•	•	•	•	•	•	02	.035	–	.10	.14	.20	.28	.32	.45	.55	.71	29	40	51	58	
	•	•	•	•	•	•	03	.043	–	.15	.21	.30	.42	.47	.67	.82	1.1	30	40	50	57	
	•	•	•	•	•	•	04	.050	–	.20	.28	.40	.57	.63	.89	1.1	1.4	30	40	50	56	

Highlighted column shows the rated pressure.



**FLAT
SPRAY**

VEEJET® NOZZLES

S STANDARD ANGLE SPRAY

**S PERFORMANCE DATA:
STANDARD ANGLE SPRAY**

Spray Angle at 40 psi	Nozzle Type/ Inlet Conn. (in.)						Capacity Size	Equiv. Orifice Dia. (in.)	Flow Rate Capacity (gallons per minute)									Spray Angle (°)			
	H-VV		H-VVL		H-DT				5 psi	10 psi	20 psi	40 psi	80 psi	100 psi	200 psi	300 psi	500 psi	20 psi	40 psi	80 psi	200 psi
	1/8	1/4	1/8	1/4	1/8	1/4															
40°	•	•	•	•	•	•	05	.056	–	.25	.35	.50	.71	.79	1.1	1.4	1.8	31	40	49	55
	•	•			•	•	055	.059	–	.28	.39	.55	.78	.87	1.2	1.5	1.9	31	40	49	55
	•	•	•	•	•	•	06	.061	–	.30	.42	.60	.85	.95	1.3	1.6	2.1	31	40	49	55
	•	•			•	•	065	.064	–	.33	.46	.65	.92	1.0	1.5	1.8	2.3	31	40	48	54
	•	•			•	•	07	.066	–	.35	.49	.70	.99	1.1	1.6	1.9	2.5	31	40	48	54
	•	•	•	•	•	•	08	.071	.28	.40	.57	.80	1.1	1.3	1.8	2.2	2.8	31	40	47	53
	•						085	.073	.30	.43	.60	.85	1.2	1.3	1.9	2.3	3.0	32	40	46	50
	•	•			•	•	09	.075	.32	.45	.64	.90	1.3	1.4	2.0	2.5	3.2	32	40	46	50
25°	•	•	•	•	•		01	.026	–	–	.07	.10	.14	.16	.22	.27	.35	14	25	34	42
	•	•	•	•	•	•	02	.035	–	–	.14	.20	.28	.32	.45	.55	.71	15	25	33	40
	•	•	•	•	•	•	03	.043	–	–	.21	.30	.42	.47	.67	.82	1.1	15	25	33	40
	•	•	•	•	•	•	04	.050	–	.20	.28	.40	.57	.63	.89	1.1	1.4	16	25	32	39
				•	•	•	045	.053	–	.23	.32	.45	.64	.71	1.0	1.2	1.6	16	25	32	39
	•	•	•	•	•	•	05	.056	–	.25	.35	.50	.71	.79	1.1	1.4	1.8	16	25	32	39
	•	•			•	•	055	.059	–	.28	.39	.55	.78	.87	1.2	1.5	1.9	16	25	31	38
	•	•	•	•	•	•	06	.061	–	.30	.42	.60	.85	.95	1.3	1.6	2.1	17	25	31	38
	•	•			•	•	065	.064	–	.33	.46	.65	.92	1.0	1.5	1.8	2.3	17	25	31	38
	•	•	•	•	•	•	07	.066	–	.35	.49	.70	.99	1.1	1.6	1.9	2.5	17	25	31	38
	•	•					075	.068	–	.38	.53	.75	1.1	1.2	1.7	2.1	2.7	17	25	31	38
	•	•	•	•	•	•	08	.071	–	.40	.57	.80	1.1	1.3	1.8	2.2	2.8	17	25	31	38
	•						085	.073	–	.43	.60	.85	1.2	1.3	1.9	2.3	3.0	18	25	31	37
	•	•			•	•	09	.075	–	.45	.64	.90	1.3	1.4	2.0	2.5	3.2	17	25	31	37
				•		15	.094	–	.75	1.1	1.5	2.1	2.4	3.4	4.1	5.3	18	25	31	37	
15°	•	•	•	•			01	.026	–	–	–	.10	.14	.16	.22	.27	.35	–	15	24	28
	•		•		•	•	02	.035	–	–	.14	.20	.28	.32	.45	.55	.71	6	15	22	27
	•	•	•	•	•	•	03	.043	–	–	.21	.30	.42	.47	.67	.82	1.1	6	15	22	27
	•	•	•	•	•	•	04	.050	–	–	.28	.40	.57	.63	.89	1.1	1.4	7	15	21	26
	•	•	•	•	•	•	05	.056	–	–	.35	.50	.71	.79	1.1	1.4	1.8	7	15	21	26
	•	•			•	•	055	.059	–	.28	.39	.55	.78	.87	1.2	1.5	1.9	7	15	21	26
	•	•	•	•	•	•	06	.061	–	.30	.42	.60	.85	.95	1.3	1.6	2.1	8	15	21	26
	•	•			•	•	065	.064	–	.33	.46	.65	.92	1.0	1.5	1.8	2.3	8	15	20	25
		•			•	•	07	.066	–	.35	.49	.70	.99	1.1	1.6	1.9	2.5	8	15	20	25
	•	•	•	•	•	•	08	.071	–	.40	.57	.80	1.1	1.3	1.8	2.2	2.8	9	15	20	25
	•	•			•	•	085	.073	–	.43	.60	.85	1.2	1.3	1.9	2.3	3.0	9	15	19	24
	•	•			•	•	09	.075	–	.45	.64	.90	1.3	1.4	2.0	2.5	3.2	9	15	19	24

Highlighted column shows the rated pressure.

S PERFORMANCE DATA:
STANDARD ANGLE SPRAY

Spray Angle at 40 psi	Nozzle Type/ Inlet Conn. (in.)										Capacity Size	Equiv. Orifice Dia. (in.)	Flow Rate Capacity (gallons per minute)										Spray Angle (°)			
	H-U					H-DU		U					5 psi	10 psi	20 psi	40 psi	80 psi	100 psi	200 psi	300 psi	500 psi	20 psi	40 psi	80 psi	200 psi	
	1/8	1/4	3/8	1/2	3/4	1/8	1/4	1	1-1/4	2																
110°		•									20	.109	.71	1.0	1.4	2.0	2.8	3.2	4.5	5.5	7.1	105	110	117	118	
95°	•	•		•		•	•				10	.079	.35	.50	.71	1.0	1.4	1.6	2.2	2.7	3.5	89	95	100	105	
	•	•		•		•	•				15	.094	.53	.75	1.1	1.5	2.1	2.4	3.4	4.1	5.3	90	95	100	105	
	•	•	•				•				20	.109	.71	1.0	1.4	2.0	2.8	3.2	4.5	5.5	7.1	90	95	100	105	
	•	•		•		•	•				30	.133	1.1	1.5	2.1	3.0	4.2	4.7	6.7	8.2	10.6	91	95	101	105	
		•	•	•			•				40	.153	1.4	2.0	2.8	4.0	5.7	6.3	8.9	11.0	14.1	92	95	100	105	
		•		•			•				50	.172	1.8	2.5	3.5	5.0	7.1	7.9	11.2	13.7	17.7	93	95	99	103	
		•		•			•				60	.188	2.1	3.0	4.2	6.0	8.5	9.5	13.4	16.4	21	93	95	99	103	
		•	•	•			•				70	.203	2.5	3.5	4.9	7.0	9.9	11.1	15.7	19.2	25	93	95	99	103	
				•							80	.217	2.8	4.0	5.7	8.0	11.3	12.6	17.9	22	28	93	95	99	102	
				•							100	.243	3.5	5.0	7.1	10.0	14.1	15.8	22	27	35	93	95	99	102	
			•							150	.297	5.3	7.5	10.6	15.0	21	24	34	41	53	93	95	99	102		
				•						400	.472	14.1	20	28	40	57	63	89	110	141	93	95	99	102		
80°	•	•	•	•		•	•				10	.079	.35	.50	.71	1.0	1.4	1.6	2.2	2.7	3.5	73	80	84	87	
	•	•		•		•	•				15	.094	.53	.75	1.1	1.5	2.1	2.4	3.4	4.1	5.3	74	80	83	86	
	•	•	•	•		•	•				20	.109	.71	1.0	1.4	2.0	2.8	3.2	4.5	5.5	7.1	74	80	83	86	
	•	•	•	•		•	•				30	.133	1.1	1.5	2.1	3.0	4.2	4.7	6.7	8.2	10.6	74	80	83	86	
	•	•	•	•		•	•				40	.153	1.4	2.0	2.8	4.0	5.7	6.3	8.9	11.0	14.1	74	80	83	86	
		•	•	•			•				50	.172	1.8	2.5	3.5	5.0	7.1	7.9	11.2	13.7	17.7	74	80	83	85	
		•	•	•			•				60	.188	2.1	3.0	4.2	6.0	8.5	9.5	13.4	16.4	21	75	80	83	85	
		•	•	•			•				70	.203	2.5	3.5	4.9	7.0	9.9	11.1	15.7	19.2	25	75	80	83	86	
			•	•							100	.243	3.5	5.0	7.1	10.0	14.1	15.8	22	27	35	75	80	83	86	
			•	•							150	.297	5.3	7.5	10.6	15.0	21	24	34	41	53	73	80	84	86	
				•	•						200	.343	7.1	10.0	14.1	20	28	32	45	55	71	74	80	82	85	
					•						400	.472	14.1	20	28	40	57	63	89	110	141	78	80	81	83	
								•		500	.528	17.7	25	35	50	71	79	112	137	177	78	80	81	83		
								•		580	.569	21	29	41	58	82	92	130	159	205	78	80	81	83		
65°	•	•	•			•	•				10	.079	.35	.50	.71	1.0	1.4	1.6	2.2	2.7	3.5	56	65	71	74	
	•	•									12	.084	.42	.60	.85	1.2	1.7	1.9	2.7	3.3	4.2	56	65	71	73	
	•	•	•	•		•	•				15	.094	.53	.75	1.1	1.5	2.1	2.4	3.4	4.1	5.3	56	65	70	73	
	•	•		•		•	•				20	.109	.71	1.0	1.4	2.0	2.8	3.2	4.5	5.5	7.1	57	65	70	73	
	•										25	.121	.88	1.3	1.8	2.5	3.5	4.0	5.6	6.8	8.8	57	65	69	73	
	•	•	•			•	•				30	.133	1.1	1.5	2.1	3.0	4.2	4.7	6.7	8.2	10.6	58	65	69	72	
	•	•	•			•	•				40	.153	1.4	2.0	2.8	4.0	5.7	6.3	8.9	11.0	14.1	59	65	68	72	
	•	•	•	•			•				50	.172	1.8	2.5	3.5	5.0	7.1	7.9	11.2	13.7	17.7	60	65	68	71	
		•	•	•			•				60	.188	2.1	3.0	4.2	6.0	8.5	9.5	13.4	16.4	21	60	65	68	71	

Highlighted column shows the rated pressure.



FLAT
SPRAY

VEEJET® NOZZLES

S STANDARD ANGLE SPRAY

S PERFORMANCE DATA:
STANDARD ANGLE SPRAY

Spray Angle at 40 psi	Nozzle Type/ Inlet Conn. (in.)										Capacity Size	Equiv. Orifice Dia. (in.)	Flow Rate Capacity (gallons per minute)										Spray Angle (°)			
	H-U					H-DU		U					5 psi	10 psi	20 psi	40 psi	80 psi	100 psi	200 psi	300 psi	500 psi	20 psi	40 psi	80 psi	200 psi	
	1/8	1/4	3/8	1/2	3/4	1/8	1/4	1	1-1/4	2																
65°		•	•	•		•	•				70	.203	2.5	3.5	4.9	7.0	9.9	11.1	15.7	19.2	25	60	65	68	71	
			•	•							100	.243	3.5	5.0	7.1	10.0	14.1	15.8	22	27	35	58	65	69	70	
			•	•							150	.297	5.3	7.5	10.6	15.0	21	24	34	41	53	59	65	68	70	
				•	•						200	.343	7.1	10.0	14.1	20	28	32	45	55	71	60	65	67	69	
					•						250	.373	8.8	12.5	17.7	25	35	40	56	68	88	60	65	67	69	
					•						300	.409	10.6	15.0	21	30	42	47	67	82	106	60	65	67	69	
						•					400	.472	14.1	20	28	40	57	63	89	110	141	60	65	67	69	
								•	•		500	.528	17.7	25	35	50	71	79	112	137	177	60	65	66	68	
50°							•				02	.035	.07	.10	.14	.20	.28	.32	.45	.55	.71	39	50	57	63	
							•				03	.043	.11	.15	.21	.30	.42	.47	.67	.82	1.1	40	50	56	62	
							•				04	.050	.14	.20	.28	.40	.57	.63	.89	1.1	1.4	42	50	56	61	
							•				05	.056	.18	.25	.35	.50	.71	.79	1.1	1.4	1.8	44	50	56	61	
							•				055	.059	.19	.28	.39	.55	.78	.87	1.2	1.5	1.9	44	50	56	61	
							•				06	.061	.21	.30	.42	.60	.85	.95	1.3	1.6	2.1	45	50	56	60	
							•				07	.066	.25	.35	.49	.70	.99	1.1	1.6	1.9	2.5	45	50	56	60	
							•				08	.071	.28	.40	.57	.80	1.1	1.3	1.8	2.2	2.8	45	50	55	60	
		•	•	•			•	•				10	.079	.35	.50	.71	1.0	1.4	1.6	2.2	2.7	3.5	45	50	55	59
			•	•	•		•	•				15	.094	.53	.75	1.1	1.5	2.1	2.4	3.4	4.1	5.3	45	50	55	59
		•	•	•	•			•				20	.109	.71	1.0	1.4	2.0	2.8	3.2	4.5	5.5	7.1	45	50	55	59
		•	•	•	•				•			30	.133	1.1	1.5	2.1	3.0	4.2	4.7	6.7	8.2	10.6	45	50	55	59
		•	•	•			•	•				40	.153	1.4	2.0	2.8	4.0	5.7	6.3	8.9	11.0	14.1	46	50	54	59
		•	•	•				•				50	.172	1.8	2.5	3.5	5.0	7.1	7.9	11.2	13.7	17.7	46	50	54	59
			•	•					•			60	.188	2.1	3.0	4.2	6.0	8.5	9.5	13.4	16.4	21	46	50	54	59
			•	•	•					•		70	.203	2.5	3.5	4.9	7.0	9.9	11.1	15.7	19.2	25	46	50	54	59
			•	•								80	.217	2.8	4.0	5.7	8.0	11.3	12.6	17.9	22	28	45	50	53	58
				•								85	.224	3.0	4.3	6.0	8.5	12.0	13.4	19.0	23	30	45	50	53	57
			•									90	.230	3.2	4.5	6.4	9.0	12.7	14.2	20	25	32	45	50	53	56
				•	•							100	.243	3.5	5.0	7.1	10.0	14.1	15.8	22	27	35	44	50	52	54
			•								110	.255	3.9	5.5	7.8	11.0	15.6	17.4	25	30	39	45	50	53	54	
			•								120	.266	4.2	6.0	8.5	12.0	17.0	19.0	27	33	42	44	50	53	55	
			•								135	.282	4.8	6.8	9.5	13.5	19.1	21	30	37	48	45	50	52	55	
			•	•							150	.297	5.3	7.5	10.6	15.0	21	24	34	41	53	45	50	52	55	
				•							200	.343	7.1	10.0	14.1	20	28	32	45	55	71	46	50	52	55	
				•							250	.384	8.8	12.5	17.7	25	35	40	56	68	88	46	50	52	55	
					•						400	.472	14.1	20	28	40	57	63	89	110	141	46	50	52	55	

Highlighted column shows the rated pressure.



S PERFORMANCE DATA:
STANDARD ANGLE SPRAY

Spray Angle at 40 psi	Nozzle Type/ Inlet Conn. (in.)											Capacity Size	Equiv. Orifice Dia. (in.)	Flow Rate Capacity (gallons per minute)										Spray Angle (°)			
	H-U					H-DU		U						5 psi	10 psi	20 psi	40 psi	80 psi	100 psi	200 psi	300 psi	500 psi	20 psi	40 psi	80 psi	200 psi	
	1/8	1/4	3/8	1/2	3/4	1/8	1/4	1	1-1/4	2																	
50°								•	•			500	.528	17.7	25	35	50	71	79	112	137	177	49	50	51	54	
								•				580	.569	21	29	41	58	82	92	130	159	205	49	50	51	53	
									•			750	.647	27	38	53	75	106	119	168	205	265	49	50	51	53	
									•			1000	.747	35	50	71	100	141	158	224	274	354	49	50	51	53	
										•		1500	.915	53	75	106	150	212	237	335	411	530	49	50	51	52	
										•		2000	1.056	71	100	141	200	283	316	447	548	707	49	50	51	52	
40°	•	•	•			•	•					10	.079	.35	.50	.71	1.0	1.4	1.6	2.2	2.7	3.5	32	40	45	48	
	•	•	•	•		•	•					15	.094	.53	.75	1.1	1.5	2.1	2.4	3.4	4.1	5.3	32	40	45	48	
	•	•	•	•		•	•					20	.109	.71	1.0	1.4	2.0	2.8	3.2	4.5	5.5	7.1	32	40	45	48	
	•	•	•			•	•					30	.133	1.1	1.5	2.1	3.0	4.2	4.7	6.7	8.2	10.6	33	40	45	48	
	•	•	•			•	•					40	.153	1.4	2.0	2.8	4.0	5.7	6.3	8.9	11.0	14.1	34	40	45	48	
		•	•	•			•					50	.172	1.8	2.5	3.5	5.0	7.1	7.9	11.2	13.7	17.7	35	40	45	48	
		•	•	•			•					60	.188	2.1	3.0	4.2	6.0	8.5	9.5	13.4	16.4	21	35	40	45	48	
		•	•	•			•					70	.203	2.5	3.5	4.9	7.0	9.9	11.1	15.7	19.2	25	35	40	45	48	
		•										80	.217	2.8	4.0	5.7	8.0	11.3	12.6	17.9	22	28	35	40	44	47	
			•	•								100	.243	3.5	5.0	7.1	10.0	14.1	15.8	22	27	35	34	40	43	46	
			•	•								150	.297	5.3	7.5	10.6	15.0	21	24	34	41	53	35	40	43	44	
				•								200	.343	7.1	10.0	14.1	20	28	32	45	55	71	36	40	42	44	
25°								•	•			500	.528	17.7	25	35	50	71	79	112	137	177	38	40	41	45	
	•	•				•	•					10	.079	.35	.50	.71	1.0	1.4	1.6	2.2	2.7	3.5	18	25	31	37	
	•	•	•			•	•					15	.094	.53	.75	1.1	1.5	2.1	2.4	3.4	4.1	5.3	18	25	31	37	
	•	•	•			•	•					20	.109	.71	1.0	1.4	2.0	2.8	3.2	4.5	5.5	7.1	19	25	31	37	
	•	•	•			•	•					30	.133	1.1	1.5	2.1	3.0	4.2	4.7	6.7	8.2	10.6	20	25	30	36	
		•	•			•	•					40	.153	1.4	2.0	2.8	4.0	5.7	6.3	8.9	11.0	14.1	21	25	29	35	
		•	•			•						50	.172	1.8	2.5	3.5	5.0	7.1	7.9	11.2	13.7	17.7	21	25	29	35	
		•	•			•						60	.188	2.1	3.0	4.2	6.0	8.5	9.5	13.4	16.4	21	22	25	29	35	
		•	•	•			•					70	.203	2.5	3.5	4.9	7.0	9.9	11.1	15.7	19.2	25	22	25	29	35	
			•	•								100	.243	3.5	5.0	7.1	10.0	14.1	15.8	22	27	35	23	25	28	32	
			•	•								150	.297	5.3	7.5	10.6	15.0	21	24	34	41	53	24	25	28	30	
				•								200	.343	7.1	10.0	14.1	20	28	32	45	55	71	24	25	26	29	
									•	•			500	.528	17.7	25	35	50	71	79	112	137	177	24	25	26	29
										•			750	.647	27	38	53	75	106	119	168	205	265	24	25	26	28
									•			1000	.747	35	50	71	100	141	158	224	274	354	24	25	26	28	
15°	•	•				•	•					10	.079	.35	.50	.71	1.0	1.4	1.6	2.2	2.7	3.5	10	15	19	24	
	•	•	•			•	•					15	.094	.53	.75	1.1	1.5	2.1	2.4	3.4	4.1	5.3	10	15	19	24	
	•	•	•			•	•					20	.109	.71	1.0	1.4	2.0	2.8	3.2	4.5	5.5	7.1	10	15	19	23	

Highlighted column shows the rated pressure.



**FLAT
SPRAY**

VEEJET® NOZZLES

S STANDARD ANGLE SPRAY

**S PERFORMANCE DATA:
STANDARD ANGLE SPRAY**

Spray Angle at 40 psi	Nozzle Type/ Inlet Conn. (in.)										Capacity Size	Equiv. Orifice Dia. (in.)	Flow Rate Capacity (gallons per minute)										Spray Angle (°)			
	H-U					H-DU		U					5 psi	10 psi	20 psi	40 psi	80 psi	100 psi	200 psi	300 psi	500 psi	20 psi	40 psi	80 psi	200 psi	
	1/8	1/4	3/8	1/2	3/4	1/8	1/4	1	1-1/4	2																
15°	•	•	•			•	•				30	.133	1.1	1.5	2.1	3.0	4.2	4.7	6.7	8.2	10.6	10	15	19	21	
	•	•	•			•	•				40	.153	1.4	2.0	2.8	4.0	5.7	6.3	8.9	11.0	14.1	10	15	18	21	
		•	•	•			•					50	.172	1.8	2.5	3.5	5.0	7.1	7.9	11.2	13.7	17.7	11	15	18	21
		•	•				•					60	.188	2.1	3.0	4.2	6.0	8.5	9.5	13.4	16.4	21	11	15	18	21
		•	•	•			•					70	.203	2.5	3.5	4.9	7.0	9.9	11.1	15.7	19.2	25	11	15	18	21
			•	•								100	.243	3.5	5.0	7.1	10.0	14.1	15.8	22	27	35	13	15	17	18
			•									120	.266	4.2	6.0	8.5	12.0	17.0	19.0	27	33	42	13	15	17	18
				•								150	.297	5.3	7.5	10.6	15.0	21	24	34	41	53	14	15	17	18
					•					•		200	.343	7.1	10.0	14.1	20	28	32	45	55	71	14	15	17	18
									•		500	.528	17.7	25	35	50	71	79	112	137	177	14	15	16	17	
									•		1000	.747	35	50	71	100	141	158	224	274	354	14	15	16	17	
0°	•	•					•				03	.041	.11	.15	.21	.30	.42	.47	.67	.82	1.1					
	•	•					•	•			04	.047	.14	.20	.28	.40	.57	.63	.89	1.1	1.4					
	•	•					•	•			05	.053	.18	.25	.35	.50	.71	.79	1.1	1.4	1.8					
	•	•					•	•			055	.055	.19	.28	.39	.55	.78	.87	1.2	1.5	1.9					
	•	•					•	•			06	.058	.21	.30	.42	.60	.85	.95	1.3	1.6	2.1					
	•	•					•	•			065	.060	.23	.33	.46	.65	.92	1.0	1.5	1.8	2.3					
		•					•	•			07	.062	.25	.35	.49	.70	.99	1.1	1.6	1.9	2.5					
	•	•					•	•			08	.067	.28	.40	.57	.80	1.1	1.3	1.8	2.2	2.8					
	•										085	.069	.30	.43	.60	.85	1.2	1.3	1.9	2.3	3.0					
	•	•					•	•			09	.071	.32	.45	.64	.90	1.3	1.4	2.0	2.5	3.2					
	•	•					•	•			10	.075	.35	.50	.71	1.0	1.4	1.6	2.2	2.7	3.5					
		•						•			12	.082	.42	.60	.85	1.2	1.7	1.9	2.7	3.3	4.2					
	•	•					•	•			15	.091	.53	.75	1.1	1.5	2.1	2.4	3.4	4.1	5.3					
	•	•	•				•	•			20	.106	.71	1.0	1.4	2.0	2.8	3.2	4.5	5.5	7.1					
	•	•					•	•			30	.129	1.1	1.5	2.1	3.0	4.2	4.7	6.7	8.2	10.6					
	•	•					•	•			40	.149	1.4	2.0	2.8	4.0	5.7	6.3	8.9	11.0	14.1					
		•						•			50	.167	1.8	2.5	3.5	5.0	7.1	7.9	11.2	13.7	17.7					
		•						•			60	.183	2.1	3.0	4.2	6.0	8.5	9.5	13.4	16.4	21					
		•	•					•			70	.198	2.5	3.5	4.9	7.0	9.9	11.1	15.7	19.2	25					
		•	•								80	.211	2.8	4.0	5.7	8.0	11.3	12.6	17.9	22	28					
		•								100	.236	3.5	5.0	7.1	10.0	14.1	15.8	22	27	35						
		•								120	.259	4.2	6.0	8.5	12.0	17.0	19.0	27	33	42						
		•		•						150	.289	5.3	7.5	10.6	15.0	21	24	34	41	53						
			•							165	.303	5.8	8.3	11.7	16.5	23	26	37	45	58						
			•							200	.334	7.1	10.0	14.1	20	28	32	45	55	71						

0
Solid Stream

Highlighted column shows the rated pressure.



S PERFORMANCE DATA:
STANDARD ANGLE SPRAY

Spray Angle at 40 psi	Nozzle Type/ Inlet Conn. (in.)										Capacity Size	Equiv. Orifice Dia. (in.)	Flow Rate Capacity (gallons per minute)										Spray Angle (°)			
	H-U					H-DU		U					5 psi	10 psi	20 psi	40 psi	80 psi	100 psi	200 psi	300 psi	500 psi	20 psi	40 psi	80 psi	200 psi	
	1/8	1/4	3/8	1/2	3/4	1/8	1/4	1	1-1/4	2																
0°			•	•							250	.373	8.8	12.5	17.7	25	35	40	56	68	88	0 Solid Stream				
					•						350	.437	12.4	17.5	25	35	49	55	78	96	124					
								•	•		570	.558	20	29	40	57	81	90	127	156	202					
					•						700	.618	25	35	49	70	99	111	157	192	247					
								•			1000	.739	35	50	71	100	141	158	224	274	354					
								•			1100	.775	39	55	78	110	156	174	246	301	389					
									•		1400	.875	49	70	99	140	198	221	313	383	495					
									•		1800	.992	64	90	127	180	255	285	402	493	636					
										•	2000	1.045	71	100	141	200	283	316	447	548	707					
										•	3500	1.383	124	175	247	350	495	553	783	959	1237					

Highlighted column shows the rated pressure.

DIMENSIONS AND WEIGHTS

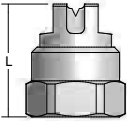
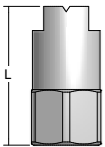
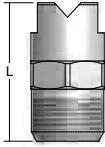
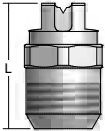
Nozzle	Nozzle Type	Inlet Conn. (in.)	L (in.)	Hex. (in.)	D (Dia.) (in.)	Net Weight (oz.)
	H-DT (F)	1/8	0.750	1/2	-	0.5
		1/4	0.780	5/8	-	0.8
	H-DU (F)	1/8	1.125	1/2	-	0.8
		1/4	1.250	5/8	-	1.3
	H-U (M)	1/8	1.000	9/16	-	0.5
		1/4	1.000	9/16	-	0.8
		3/8	1.250	11/16	-	1.5
		1/2	1.500	7/8	-	2.3
		3/4	2.000	1-1/16	-	5
	H-VV (M)	1/8	0.875	1/2	-	0.5
		1/4	0.906	9/16	-	0.8

Based on the largest/heaviest version of each type.

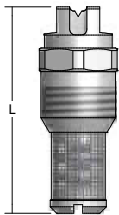
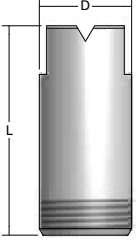
Nozzle	Nozzle Type	Inlet Conn. (in.)	L (in.)	Hex. (in.)	D (Dia.) (in.)	Net Weight (oz.)
	H-VVL (M)	1/8	1.531	1/2	-	0.8
		1/4	1.250	9/16	-	1
	U (M)	1	2.313	-	1.313	9
		1-1/4	3.750	-	1.688	20
		2	5.375	-	2.375	68

Based on the largest/heaviest version of each type.



**FLAT
SPRAY**

QUICK VEEJET® AND PROMAX® QUICK VEEJET NOZZLES

S STANDARD ANGLE SPRAY

OVERVIEW: QUICK VEEJET AND PROMAX QUICK VEEJET

- Ideal for high-maintenance operations – bodies remain on pipe/header; quick quarter-turn removes/installs spray tips in seconds
- Automatic alignment feature saves time
- Miniature versions are ideal when smaller physical size and lower weight are important
- Flat fan type, tapered edge spray pattern
- Spray angles from 0° to 110°
- Uniform spray distribution with flow rates from .035 to 68 gpm (.14 to 255 lpm)
- Operating pressures up to 300 psi (20 bar)
- Choice of metal or ProMax. ProMax features:
 - ProMax material, a special grade of polypropylene, resists build-up and chemical attack; for use up to 150 psi (10 bar)
 - Internal O-ring provides a positive seal between the body and tip; seal remains attached to tip eliminating accidental loss
 - Optional external O-ring protects nozzle from contaminants
 - Tips are color-coded for easy flow rate identification

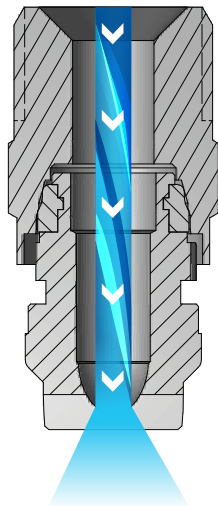

Quick VeeJet and ProMax Quick VeeJet Nozzles

As the liquid exits through the sharp V shape cut of the orifice, it forms into a flat spray pattern. The distribution is tapered from the center of the spray.

QUICK VEEJET AND MINIATURE QUICK VEEJET OPTIONS

S



QLUA Spray Tip + QJLA Body
3/8" to 1/2" male conn.



QJLA Body
3/8" to 1/2" female conn.



QJA Body
1/8" to 1/2" female conn.



QJJA Body
1/8" to 1/2" male conn.



QJJS Body – Miniature version
1/8" to 1/4" male conn.

S



QUA Spray Tip
Flow rates of 1 to 8 gpm at 40 psi
(3.9 to 32 lpm at 2.8 bar)
Use with QJA or QJJA bodies

S



QVVA Spray Tip
Flow rates below 1 gpm at 40 psi
(3.9 lpm at 2.8 bar)
Use with QJA or QJJA bodies

S



QSVV Spray Tip – Miniature version
Flow rates below 1 gpm at 40 psi
(3.9 lpm at 2.8 bar)
Use with QJJS body

QUICK VEEJET® AND PROMAX® QUICK VEEJET NOZZLES

S STANDARD ANGLE SPRAY

FLAT SPRAY

PROMAX QUICK VEEJET AND PROMAX MINIATURE QUICK VEEJET OPTIONS



OPTA Spray Tip + QPPA Body
1/4" to 3/8" male conn.
Optional external O-ring



QMVV Miniature Spray Tip + QPPM Miniature Body
1/8" to 1/4" male conn.
Options: body strainer, tip strainer and external O-ring

 <p>OPTA Spray Tip – White 1.0 gpm (3.9 lpm) Use with QPPA body</p>	 <p>OPTA Spray Tip – Grey 1.5 gpm (5.9 lpm) Use with QPPA body</p>	 <p>QMVV Spray Tip – White .10 gpm (.38 lpm) Use with QPPM body</p>	 <p>QMVV Spray Tip – Red .15 gpm (.59 lpm) Use with QPPM body</p>
 <p>OPTA Spray Tip – Black 2.0 gpm (7.9 lpm) Use with QPPA body</p>	 <p>OPTA Spray Tip – Orange 3.0 gpm (11.8 lpm) Use with QPPA body</p>	 <p>QMVV Spray Tip – Gray .20 gpm (.79 lpm) Use with QPPM body</p>	 <p>QMVV Spray Tip – Black .30 gpm (1.2 lpm) Use with QPPM body</p>
 <p>OPTA Spray Tip – Green 4.0 gpm (15.8 lpm) Use with QPPA body</p>	 <p>OPTA Spray Tip – Yellow 5.0 gpm (19.7 lpm) Use with QPPA body</p>	 <p>QMVV Spray Tip – Orange .40 gpm (1.6 lpm) Use with QPPM body</p>	 <p>QMVV Spray Tip – Green .50 gpm (2.0 lpm) Use with QPPM body</p>
 <p>OPTA Spray Tip – Blue 6.0 gpm (24 lpm) Use with QPPA body</p>	 <p>OPTA Spray Tip – Red 7.0 gpm (28 lpm) Use with QPPA body</p>	 <p>QMVV Spray Tip – Yellow .60 gpm (2.4 lpm) Use with QPPM body</p>	 <p>QMVV Spray Tip – Blue .80 gpm (3.2 lpm) Use with QPPM body</p>

Capacities at 40 psi (2.8 bar).

**RELATIVE DROP SIZE
IN MICRONS**

 10 to 100	 100 to 500	 500 to 1000	 1000 to 5000
---	--	---	--

Drop size will vary based on flow rate and pressure.

ORDERING INFORMATION

METAL QUICK VEEJET

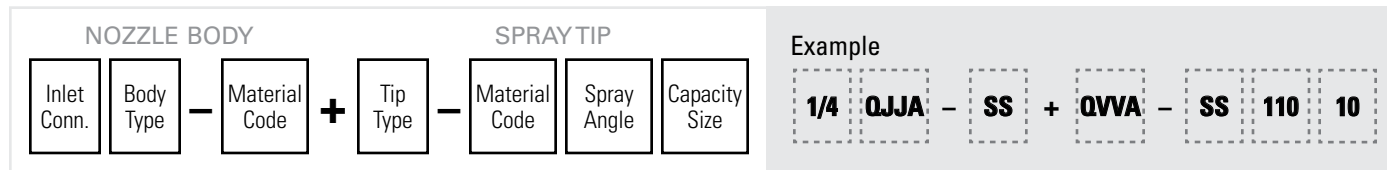

BSPT connections require the addition of a "B" prior to the inlet connection.

PROMAX QUICK VEEJET

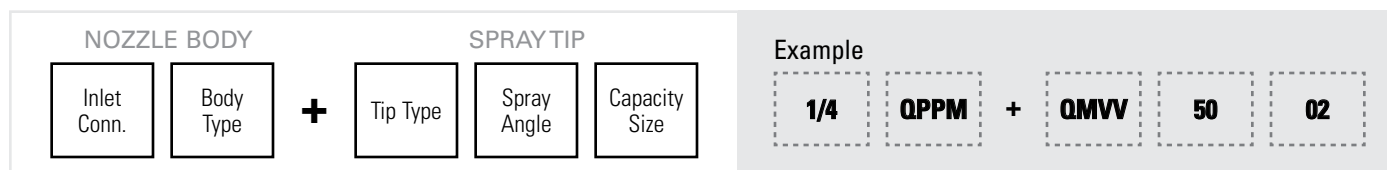

BSPT connections require the addition of a "B" prior to the inlet connection.

Options for miniature ProMax Quick VeeJet nozzles:

1/8" conn.: Kynar body strainer: CP39212-1-KY

1/4" conn.: Kynar body strainer: CP39212-2-KY

Kynar tip strainer: CP45095

External O-ring: CP7717-2/13-VI

Optional external O-ring for standard ProMax Quick VeeJet nozzle: CP7717-2/17-VI

QUICK REFERENCE GUIDE

Model	Connection	Connection Size (in.)	Materials	Page Number	
				Performance Data	Dimensions and Weights
QJJS body	M	1/8 to 1/4	Brass, 303 stainless steel (SS)	–	C23
QSVV spray tip	NA	NA		C17–C22	
QJA and QJLA bodies	F	1/8 to 1/2		–	
QJJA and QJJLA bodies	M	1/8 to 1/2		–	
QLUA, QUA and QVVA spray tips	NA	NA		C17–C22	
QPPM body	M	1/8 to 1/4	ProMax	–	C17–C22
QMVV spray tips	NA	NA		C17–C22	
QPPA body	M	1/8 to 1/2		–	
QPTA spray tips	NA	NA		C17–C22	

F = female thread; M = male thread; NA = not applicable. There is no material code for brass. Leave material code blank when ordering. For ProMax, the material code is built into part number. Other materials available upon request.

For more dimensions and sizes, contact your sales engineer.

See page B16 for maximum operating pressures for ProMax QuickJet nozzles at various temperatures.



QUICK VEEJET® AND PROMAX® QUICK VEEJET NOZZLES

S STANDARD ANGLE SPRAY

FLAT SPRAY

PERFORMANCE DATA: STANDARD ANGLE SPRAY																					
Spray Angle at 40 psi	Quick VeeJet Tip Type						Capacity Size	Equiv. Orifice Dia. (in.)	Flow Rate Capacity (gallons per minute)									Spray Angle (°)			
	QSVV	QVVA	QUA	QLUA	QMVV	QPTA			5 psi	10 psi	20 psi	40 psi	80 psi	100 psi	175* psi	200** psi	300 psi	20 psi	40 psi	80 psi	200 psi
110°	•	•					01	.026	.035	.05	.07	.10	.14	.16	.21	.22	.27	94	110	121	124
	•	•			•		015	.032	.05	.08	.11	.15	.21	.24	.31	.34	.41	97	110	121	124
	•	•			•		02	.036	.07	.10	.14	.20	.28	.32	.42	.45	.55	98	110	120	123
	•	•			•		03	.043	.11	.15	.21	.30	.42	.47	.63	.67	.82	99	110	120	123
		•			•		04	.050	.14	.20	.28	.40	.57	.63	.84	.89	1.1	100	110	119	122
		•			•		05	.056	.18	.25	.35	.50	.71	.79	1.0	1.1	1.4	100	110	118	122
		•			•		06	.061	.21	.30	.42	.60	.85	.95	1.3	1.3	1.6	101	110	117	122
	•	•			•		08	.071	.28	.40	.57	.80	1.1	1.3	1.7	1.8	2.2	102	110	117	121
		•					10	.079	.35	.50	.71	1.0	1.4	1.6	2.1	2.2	2.7	103	110	117	119
		•					15	.094	.53	.75	1.1	1.5	2.1	2.4	3.1	3.4	4.1	104	110	117	118
		•					20	.109	.71	1.0	1.4	2.0	2.8	3.2	4.2	4.5	5.5	105	110	117	118
95°	•	•					01	.026	.035	.05	.07	.10	.14	.16	.21	.22	.27	81	95	105	113
		•			•		015	.032	.05	.08	.11	.15	.21	.24	.31	.34	.41	82	95	105	113
		•			•		02	.036	.07	.10	.14	.20	.28	.32	.42	.45	.55	82	95	105	113
		•			•		03	.043	.11	.15	.21	.30	.42	.47	.63	.67	.82	83	95	104	111
		•			•		04	.050	.14	.20	.28	.40	.57	.63	.84	.89	1.1	84	95	103	108
		•			•		05	.056	.18	.25	.35	.50	.71	.79	1.0	1.1	1.4	84	95	102	107
		•			•		06	.061	.21	.30	.42	.60	.85	.95	1.3	1.3	1.6	86	95	101	106
		•			•		08	.071	.28	.40	.57	.80	1.1	1.3	1.7	1.8	2.2	87	95	100	105
			•			•	10	.079	.35	.50	.71	1.0	1.4	1.6	2.1	2.2	2.7	89	95	100	105
			•			•	15	.094	.53	.75	1.1	1.5	2.1	2.4	3.1	3.4	4.1	90	95	100	105
			•			•	20	.109	.71	1.0	1.4	2.0	2.8	3.2	4.2	4.5	5.5	90	95	100	105
			•			•	30	.133	1.1	1.5	2.1	3.0	4.2	4.7	6.3	6.7	8.2	91	95	101	105
			•			•	40	.153	1.4	2.0	2.8	4.0	5.7	6.3	8.4	8.9	11.0	92	95	100	105
			•			•	50	.172	1.8	2.5	3.5	5.0	7.1	7.9	10.5	11.2	13.7	93	95	99	103
			•			•	60	.188	2.1	3.0	4.2	6.0	8.5	9.5	12.5	13.4	16.4	93	95	99	103
			•			•	70	.203	2.5	3.5	4.9	7.0	9.9	11.1	14.6	15.7	19.2	93	95	99	103
				•			100	.243	3.5	5.0	7.1	10.0	14.1	15.8	21	22	27	93	95	99	102
	•					150	.297	5.3	7.5	10.6	15.0	21	24	31	34	41	93	95	99	102	
80°	•	•					0050	.018	–	–	.035	.050	.07	.08	.10	.11	.14	61	80	95	101
	•	•					0067	.021	–	.033	.05	.067	.09	.11	.14	.15	.18	67	80	94	99
	•	•					01	.026	–	.05	.07	.10	.14	.16	.21	.22	.27	68	80	89	92
	•	•					015	.032	–	.08	.11	.15	.21	.24	.31	.34	.41	68	80	89	92
	•	•			•		02	.036	.07	.10	.14	.20	.28	.32	.42	.45	.55	69	80	88	91

*Maximum pressure for QMVV is 175 psi.

**Maximum pressure for QPTA is 200 psi.

Highlighted column shows the rated pressure.



FLAT
SPRAY

QUICK VEEJET® AND PROMAX® QUICK VEEJET NOZZLES

S STANDARD ANGLE SPRAY

S PERFORMANCE DATA:
STANDARD ANGLE SPRAY

Spray Angle at 40 psi	Quick VeeJet Tip Type						Capacity Size	Equiv. Orifice Dia. (in.)	Flow Rate Capacity (gallons per minute)									Spray Angle (°)			
	QSVV	QVVA	QUA	QLUA	QMVV	QPTA			5 psi	10 psi	20 psi	40 psi	80 psi	100 psi	175* psi	200** psi	300 psi	20 psi	40 psi	80 psi	200 psi
80°	•	•			•		03	.043	.11	.15	.21	.30	.42	.47	.63	.67	.82	70	80	87	90
	•	•			•		04	.050	.14	.20	.28	.40	.57	.63	.84	.89	1.1	71	80	86	89
		•			•		05	.056	.18	.25	.35	.50	.71	.79	1.0	1.1	1.4	71	80	86	89
	•	•			•		06	.061	.21	.30	.42	.60	.85	.95	1.3	1.3	1.6	72	80	85	88
	•	•			•		08	.071	.28	.40	.57	.80	1.1	1.3	1.7	1.8	2.2	72	80	84	87
			•			•	10	.079	.35	.50	.71	1.0	1.4	1.6	2.1	2.2	2.7	73	80	84	87
			•			•	15	.094	.53	.75	1.1	1.5	2.1	2.4	3.1	3.4	4.1	74	80	83	86
			•			•	20	.109	.71	1.0	1.4	2.0	2.8	3.2	4.2	4.5	5.5	74	80	83	86
			•			•	30	.133	1.1	1.5	2.1	3.0	4.2	4.7	6.3	6.7	8.2	74	80	83	86
			•			•	40	.153	1.4	2.0	2.8	4.0	5.7	6.3	8.4	8.9	11.0	74	80	83	86
			•			•	50	.172	1.8	2.5	3.5	5.0	7.1	7.9	10.5	11.2	13.7	74	80	83	85
			•			•	60	.188	2.1	3.0	4.2	6.0	8.5	9.5	12.5	13.4	16.4	75	80	83	85
			•			•	70	.203	2.5	3.5	4.9	7.0	9.9	11.1	14.6	15.7	19.2	75	80	83	86
				•			100	.243	3.5	5.0	7.1	10.0	14.1	15.8	21	22	27	75	80	83	86
			•			150	.297	5.3	7.5	10.6	15.0	21	24	31	34	41	73	80	84	86	
			•			200	.343	7.1	10.0	14.1	20	28	32	42	45	55	74	80	82	85	
73°		•					0023	.012	-	-	.016	.023	.032	.036	.05	.051	.063	50	73	89	97
		•					0039	.016	-	.020	.028	.039	.055	.062	.08	.087	.11	53	73	87	93
		•					0077	.023	-	.039	.055	.077	.11	.12	.16	.17	.21	53	73	86	92
		•					0116	.028	.041	.058	.082	.12	.16	.18	.24	.26	.32	54	73	85	90
		•					0154	.032	.054	.077	.11	.15	.22	.24	.32	.34	.42	55	73	84	88
		•					0231	.038	.082	.12	.16	.23	.33	.37	.48	.52	.63	56	73	83	87
		•					0308	.044	.11	.15	.22	.31	.44	.49	.64	.69	.84	58	73	82	86
		•					0385	.049	.14	.19	.27	.39	.54	.61	.81	.86	1.1	59	73	81	85
		•					0462	.054	.16	.23	.33	.46	.65	.73	.97	1.0	1.3	60	73	80	84
		•					0616	.062	.22	.31	.44	.62	.87	.97	1.3	1.4	1.7	63	73	79	83
		•					0770	.069	.27	.39	.54	.77	1.1	1.2	1.6	1.7	2.1	64	73	77	82
		•					0924	.076	.33	.46	.65	.92	1.3	1.5	1.9	2.1	2.5	65	73	77	80
65°	•						0017	.011	-	-	.012	.017	.024	.027	.04	.038	.047	44	65	77	86
	•						0025	.013	-	-	.018	.025	.035	.040	.05	.06	.07	45	65	77	84
	•						0033	.015	-	-	.023	.033	.047	.052	.07	.07	.09	47	65	76	83
	•						0050	.018	-	-	.035	.050	.07	.08	.10	.11	.14	48	65	75	82
	•						0067	.021	-	.033	.05	.067	.09	.11	.14	.15	.18	50	65	75	81
	•						01	.026	-	.05	.07	.10	.14	.16	.21	.22	.27	51	65	74	80
	•						015	.032	-	.08	.11	.15	.21	.24	.31	.34	.41	51	65	74	80
	•	•			•		02	.036	.07	.10	.14	.20	.28	.32	.42	.45	.55	52	65	73	79

*Maximum pressure for QMVV is 175 psi.

**Maximum pressure for QPTA is 200 psi.

Highlighted column shows the rated pressure.



QUICK VEEJET® AND PROMAX® QUICK VEEJET NOZZLES

S STANDARD ANGLE SPRAY

FLAT SPRAY

S PERFORMANCE DATA:
STANDARD ANGLE SPRAY

Spray Angle at 40 psi	Quick VeeJet Tip Type						Capacity Size	Equiv. Orifice Dia. (in.)	Flow Rate Capacity (gallons per minute)									Spray Angle (°)			
	QSVV	QVVA	QUA	QLUA	QMVV	QPTA			5 psi	10 psi	20 psi	40 psi	80 psi	100 psi	175* psi	200** psi	300 psi	20 psi	40 psi	80 psi	200 psi
65°	•	•			•		03	.043	.11	.15	.21	.30	.42	.47	.63	.67	.82	53	65	72	78
		•			•		04	.050	.14	.20	.28	.40	.57	.63	.84	.89	1.1	53	65	72	76
		•			•		05	.056	.18	.25	.35	.50	.71	.79	1.0	1.1	1.4	53	65	72	76
		•			•		06	.061	.21	.30	.42	.60	.85	.95	1.3	1.3	1.6	54	65	72	75
		•			•		08	.071	.28	.40	.57	.80	1.1	1.3	1.7	1.8	2.2	55	65	71	74
			•			•	10	.079	.35	.50	.71	1.0	1.4	1.6	2.1	2.2	2.7	56	65	71	74
			•			•	15	.094	.53	.75	1.1	1.5	2.1	2.4	3.1	3.4	4.1	56	65	70	73
			•			•	20	.109	.71	1.0	1.4	2.0	2.8	3.2	4.2	4.5	5.5	57	65	70	73
			•			•	30	.133	1.1	1.5	2.1	3.0	4.2	4.7	6.3	6.7	8.2	58	65	69	72
			•			•	40	.153	1.4	2.0	2.8	4.0	5.7	6.3	8.4	8.9	11.0	59	65	68	72
			•			•	50	.172	1.8	2.5	3.5	5.0	7.1	7.9	10.5	11.2	13.7	60	65	68	71
			•			•	60	.188	2.1	3.0	4.2	6.0	8.5	9.5	12.5	13.4	16.4	60	65	68	71
			•			•	70	.203	2.5	3.5	4.9	7.0	9.9	11.1	14.6	15.7	19.2	60	65	68	71
				•			100	.243	3.5	5.0	7.1	10.0	14.1	15.8	21	22	27	58	65	69	70
				•			150	.297	5.3	7.5	10.6	15.0	21	24	31	34	41	59	65	68	70
			•			200	.343	7.1	10.0	14.1	20	28	32	42	45	55	60	65	67	69	
50°		•					0017	.011	–	–	.012	.017	.024	.027	.04	.038	.047	27	50	65	74
		•					0025	.013	–	–	.018	.025	.035	.040	.05	.06	.07	29	50	64	71
		•					0033	.015	–	–	.023	.033	.047	.052	.07	.07	.09	30	50	62	68
		•					0050	.018	–	–	.035	.050	.07	.08	.10	.11	.14	32	50	60	66
		•					0067	.021	–	–	.05	.067	.09	.11	.14	.15	.18	35	50	60	66
		•					01	.026	–	.05	.07	.10	.14	.16	.21	.22	.27	37	50	59	65
		•					015	.032	–	.08	.11	.15	.21	.24	.31	.34	.41	38	50	58	64
		•			•		02	.036	–	.10	.14	.20	.28	.32	.42	.45	.55	39	50	57	63
		•			•		03	.043	.11	.15	.21	.30	.42	.47	.63	.67	.82	40	50	56	62
		•			•		04	.050	.14	.20	.28	.40	.57	.63	.84	.89	1.1	42	50	56	61
		•			•		05	.056	.18	.25	.35	.50	.71	.79	1.0	1.1	1.4	44	50	56	61
		•			•		06	.061	.21	.30	.42	.60	.85	.95	1.3	1.3	1.6	45	50	56	60
		•			•		08	.071	.28	.40	.57	.80	1.1	1.3	1.7	1.8	2.2	45	50	55	60
			•			•	10	.079	.35	.50	.71	1.0	1.4	1.6	2.1	2.2	2.7	45	50	55	59
			•			•	15	.094	.53	.75	1.1	1.5	2.1	2.4	3.1	3.4	4.1	45	50	55	59
			•			•	20	.109	.71	1.0	1.4	2.0	2.8	3.2	4.2	4.5	5.5	45	50	55	59
			•			•	30	.133	1.1	1.5	2.1	3.0	4.2	4.7	6.3	6.7	8.2	45	50	55	59
			•			•	40	.153	1.4	2.0	2.8	4.0	5.7	6.3	8.4	8.9	11.0	46	50	54	59
			•			•	50	.172	1.8	2.5	3.5	5.0	7.1	7.9	10.5	11.2	13.7	46	50	54	59
			•			•	60	.188	2.1	3.0	4.2	6.0	8.5	9.5	12.5	13.4	16.4	46	50	54	59

*Maximum pressure for QMVV is 175 psi.

**Maximum pressure for QPTA is 200 psi.

Highlighted column shows the rated pressure.



QUICK VEEJET® AND PROMAX® QUICK VEEJET NOZZLES

S STANDARD ANGLE SPRAY

S PERFORMANCE DATA:
STANDARD ANGLE SPRAY

Spray Angle at 40 psi	Quick VeeJet Tip Type						Capacity Size	Equiv. Orifice Dia. (in.)	Flow Rate Capacity (gallons per minute)										Spray Angle (°)			
	QSVV	QVVA	QUA	QLUA	QMVV	QPTA			5 psi	10 psi	20 psi	40 psi	80 psi	100 psi	175* psi	200** psi	300 psi	20 psi	40 psi	80 psi	200 psi	
50°			●			●	70	.203	2.5	3.5	4.9	7.0	9.9	11.1	14.6	15.7	19.2	46	50	54	59	
				●			100	.243	3.5	5.0	7.1	10.0	14.1	15.8	21	22	27	44	50	52	54	
				●			120	.266	4.2	6.0	8.5	12.0	17.0	19.0	25	27	33	44	50	53	55	
				●			150	.297	5.3	7.5	10.6	15.0	21	24	31	34	41	45	50	52	55	
				●			200	.343	7.1	10.0	14.1	20	28	32	42	45	55	46	50	52	55	
40°		●					0017	.011	–	–	.012	.017	.024	.027	.04	.038	.047	21	40	54	61	
		●					0025	.013	–	–	.018	.025	.035	.040	.05	.06	.07	22	40	53	60	
		●					0033	.015	–	–	.023	.033	.047	.052	.07	.07	.09	22	40	53	60	
		●					0050	.018	–	–	.035	.050	.07	.08	.10	.11	.14	22	40	53	60	
		●					0067	.021	–	–	.05	.067	.09	.11	.14	.15	.18	24	40	53	60	
		●					01	.026	–	–	.07	.10	.14	.16	.21	.22	.27	26	40	52	59	
		●					015	.032	–	–	.11	.15	.21	.24	.31	.34	.41	27	40	52	59	
		●			●		02	.036	–	.10	.14	.20	.28	.32	.42	.45	.55	29	40	51	58	
		●			●		03	.043	–	.15	.21	.30	.42	.47	.63	.67	.82	30	40	50	57	
		●			●		04	.050	–	.20	.28	.40	.57	.63	.84	.89	1.1	30	40	50	56	
		●			●		05	.056	–	.25	.35	.50	.71	.79	1.0	1.1	1.4	31	40	49	55	
		●			●		06	.061	–	.30	.42	.60	.85	.95	1.3	1.3	1.6	31	40	49	55	
		●			●		08	.071	.28	.40	.57	.80	1.1	1.3	1.7	1.8	2.2	31	40	47	53	
			●			●	10	.079	.35	.50	.71	1.0	1.4	1.6	2.1	2.2	2.7	32	40	45	48	
			●			●	15	.094	.53	.75	1.1	1.5	2.1	2.4	3.1	3.4	4.1	32	40	45	48	
			●			●	20	.109	.71	1.0	1.4	2.0	2.8	3.2	4.2	4.5	5.5	32	40	45	48	
			●			●	30	.133	1.1	1.5	2.1	3.0	4.2	4.7	6.3	6.7	8.2	33	40	45	48	
			●			●	40	.153	1.4	2.0	2.8	4.0	5.7	6.3	8.4	8.9	11.0	34	40	45	48	
			●			●	50	.172	1.8	2.5	3.5	5.0	7.1	7.9	10.5	11.2	13.7	35	40	45	48	
			●			●	60	.188	2.1	3.0	4.2	6.0	8.5	9.5	12.5	13.4	16.4	35	40	45	48	
		●			●	70	.203	2.5	3.5	4.9	7.0	9.9	11.1	14.6	15.7	19.2	35	40	45	48		
			●			100	.243	3.5	5.0	7.1	10.0	14.1	15.8	21	22	27	34	40	43	46		
			●			150	.297	5.3	7.5	10.6	15.0	21	24	31	34	41	35	40	43	44		
			●			200	.343	7.1	10.0	14.1	20	28	32	42	45	55	36	40	42	44		
25°		●					0017	.011	–	–	–	.017	.024	.027	.04	.038	.047	–	25	35	47	
		●					0025	.013	–	–	–	.025	.035	.040	.05	.06	.07	–	25	35	45	
		●					0033	.015	–	–	–	.033	.047	.052	.07	.07	.09	–	25	34	44	
		●					0050	.018	–	–	–	.050	.07	.08	.10	.11	.14	–	25	34	43	
		●					0067	.021	–	–	–	.067	.09	.11	.14	.15	.18	–	25	34	42	
		●					01	.026	–	–	.07	.10	.14	.16	.21	.22	.27	14	25	34	42	
		●					015	.032	–	–	.11	.15	.21	.24	.31	.34	.41	15	25	34	41	

*Maximum pressure for QMVV is 175 psi.

**Maximum pressure for QPTA is 200 psi.

Highlighted column shows the rated pressure.



QUICK VEEJET® AND PROMAX® QUICK VEEJET NOZZLES

S STANDARD ANGLE SPRAY

FLAT SPRAY

S PERFORMANCE DATA:
STANDARD ANGLE SPRAY

Spray Angle at 40 psi	Quick VeeJet Tip Type						Capacity Size	Equiv. Orifice Dia. (in.)	Flow Rate Capacity (gallons per minute)									Spray Angle (°)				
	QSVV	QVVA	QUA	QLUA	QMVV	QPTA			5 psi	10 psi	20 psi	40 psi	80 psi	100 psi	175* psi	200** psi	300 psi	20 psi	40 psi	80 psi	200 psi	
25°		•			•		02	.036	–	–	.14	.20	.28	.32	.42	.45	.55	15	25	33	40	
		•			•		03	.043	–	–	.21	.30	.42	.47	.63	.67	.82	15	25	33	40	
		•			•		04	.050	–	.20	.28	.40	.57	.63	.84	.89	1.1	1.6	25	32	39	40
		•			•		05	.056	–	.25	.35	.50	.71	.79	1.0	1.1	1.4	1.6	25	32	39	40
		•			•		06	.061	–	.30	.42	.60	.85	.95	1.3	1.3	1.6	1.7	25	31	38	40
		•			•		08	.071	–	.40	.57	.80	1.1	1.3	1.7	1.8	2.2	1.7	25	31	38	40
			•			•	10	.079	–	.50	.71	1.0	1.4	1.6	2.1	2.2	2.7	18	25	31	37	40
			•			•	15	.094	–	.75	1.1	1.5	2.1	2.4	3.1	3.4	4.1	18	25	31	37	40
			•			•	20	.109	–	1.0	1.4	2.0	2.8	3.2	4.2	4.5	5.5	19	25	31	37	40
			•			•	30	.133	1.1	1.5	2.1	3.0	4.2	4.7	6.3	6.7	8.2	20	25	30	36	40
			•			•	40	.153	1.4	2.0	2.8	4.0	5.7	6.3	8.4	8.9	11.0	21	25	29	35	40
			•			•	50	.172	1.8	2.5	3.5	5.0	7.1	7.9	10.5	11.2	13.7	21	25	29	35	40
			•			•	60	.188	2.1	3.0	4.2	6.0	8.5	9.5	12.5	13.4	16.4	22	25	29	35	40
			•			•	70	.203	2.5	3.5	4.9	7.0	9.9	11.1	14.6	15.7	19.2	22	25	29	35	40
				•			100	.243	3.5	5.0	7.1	10.0	14.1	15.8	21	22	27	23	25	28	32	40
				•			150	.297	5.3	7.5	10.6	15.0	21	24	31	34	41	24	25	28	30	40
			•			200	.343	7.1	10.0	14.1	20	28	32	42	45	55	24	25	26	29	40	
15°		•					0017	.011	–	–	–	.017	.024	.027	.04	.038	.047	–	15	30	37	40
		•					0025	.013	–	–	–	.025	.035	.040	.05	.06	.07	–	15	28	34	40
		•					0033	.015	–	–	–	.033	.047	.052	.07	.07	.09	–	15	27	32	40
		•					0050	.018	–	–	–	.050	.07	.08	.10	.11	.14	–	15	26	30	40
		•					0067	.021	–	–	–	.067	.09	.11	.14	.15	.18	–	15	25	29	40
		•					01	.026	–	–	–	.10	.14	.16	.21	.22	.27	–	15	24	28	40
		•					015	.032	–	–	–	.15	.21	.24	.31	.34	.41	–	15	23	27	40
		•					02	.036	–	–	.14	.20	.28	.32	.42	.45	.55	6	15	22	27	40
		•					03	.043	–	–	.21	.30	.42	.47	.63	.67	.82	6	15	22	27	40
		•					04	.050	–	–	.28	.40	.57	.63	.84	.89	1.1	7	15	21	26	40
		•					05	.055	–	–	.35	.50	.71	.79	1.0	1.1	1.4	7	15	21	26	40
		•					06	.061	–	–	.42	.60	.85	.95	1.3	1.3	1.6	8	15	21	26	40
		•					08	.071	–	–	.57	.80	1.1	1.3	1.7	1.8	2.2	9	15	20	25	40
			•				10	.079	.35	.50	.71	1.0	1.4	1.6	2.1	2.2	2.7	10	15	19	24	40
			•				15	.094	.53	.75	1.1	1.5	2.1	2.4	3.1	3.4	4.1	10	15	19	24	40
			•				20	.109	.71	1.0	1.4	2.0	2.8	3.2	4.2	4.5	5.5	10	15	19	23	40
		•				30	.133	1.1	1.5	2.1	3.0	4.2	4.7	6.3	6.7	8.2	10	15	19	21	40	
		•				40	.153	1.4	2.0	2.8	4.0	5.7	6.3	8.4	8.9	11.0	10	15	18	21	40	
		•				50	.172	1.8	2.5	3.5	5.0	7.1	7.9	10.5	11.2	13.7	11	15	18	21	40	

*Maximum pressure for QMVV is 175 psi.

**Maximum pressure for QPTA is 200 psi.

Highlighted column shows the rated pressure.



FLAT
SPRAY

QUICK VEEJET® AND PROMAX® QUICK VEEJET NOZZLES

S STANDARD ANGLE SPRAY

S PERFORMANCE DATA:
STANDARD ANGLE SPRAY

Spray Angle at 40 psi	Quick VeeJet Tip Type						Capacity Size	Equiv. Orifice Dia. (in.)	Flow Rate Capacity (gallons per minute)									Spray Angle (°)			
	QSVV	QVVA	QUA	QLUA	QMVV	QPTA			5 psi	10 psi	20 psi	40 psi	80 psi	100 psi	175* psi	200** psi	300 psi	20 psi	40 psi	80 psi	200 psi
15°			•				60	.188	2.1	3.0	4.2	6.0	8.5	9.5	12.5	13.4	16.4	11	15	18	21
			•				70	.203	2.5	3.5	4.9	7.0	9.9	11.1	14.6	15.7	19.2	11	15	18	21
				•			100	.243	3.5	5.0	7.1	10.0	14.1	15.8	21	22	27	13	15	17	18
				•			120	.266	4.2	6.0	8.5	12.0	17.0	19.0	25	27	33	13	15	17	18
				•			150	.297	5.3	7.5	10.6	15.0	21	24	31	34	41	14	15	17	18
				•			200	.343	7.1	10.0	14.1	20	28	32	42	45	55	14	15	17	18
0°		•					0009	.008	.003	.003	.005	.009	.013	.014	.020	.020	.025	0 Solid Stream			
		•					0012	.010	.004	.006	.008	.012	.017	.019	.027	.027	.033				
		•					0019	.012	.007	.009	.013	.019	.027	.030	.043	.043	.052				
	•	•					0021	.013	.007	.010	.011	.023	.033	.040	.047	.047	.052				
		•					0050	.019	.018	.025	.035	.050	.07	.08	.10	.11	.14				
		•					0067	.023	.024	.033	.05	.067	.09	.11	.14	.15	.18				
		•					01	.028	.035	.05	.07	.10	.14	.16	.21	.22	.27				
		•					015	.034	.05	.08	.11	.15	.21	.24	.31	.34	.41				
		•					02	.039	.07	.10	.14	.20	.28	.32	.42	.45	.55				
		•	•				03	.041	.11	.15	.21	.30	.42	.47	.63	.67	.82				
		•	•				04	.047	.14	.20	.28	.40	.57	.63	.84	.89	1.1				
		•	•				05	.053	.18	.25	.35	.50	.71	.79	1.0	1.1	1.4				
		•	•				06	.058	.21	.30	.42	.60	.85	.95	1.3	1.3	1.6				
		•	•				08	.067	.28	.40	.57	.80	1.1	1.3	1.7	1.8	2.2				
			•				10	.075	.35	.50	.71	1.0	1.4	1.6	2.1	2.2	2.7				
			•				15	.091	.53	.75	1.1	1.5	2.1	2.4	3.1	3.4	4.1				
			•				20	.106	.71	1.0	1.4	2.0	2.8	3.2	4.2	4.5	5.5				
			•				30	.129	1.1	1.5	2.1	3.0	4.2	4.7	6.3	6.7	8.2				
			•				40	.149	1.4	2.0	2.8	4.0	5.7	6.3	8.4	8.9	11.0				
			•				50	.167	1.8	2.5	3.5	5.0	7.1	7.9	10.5	11.2	13.7				
			•				60	.183	2.1	3.0	4.2	6.0	8.5	9.5	12.5	13.4	16.4				
			•				70	.198	2.5	3.5	4.9	7.0	9.9	11.1	14.6	15.7	19.2				
			•				80	.211	2.8	4.0	5.7	8.0	11.3	12.6	16.7	17.9	22				
				•			100	.236	3.5	5.0	7.1	10.0	14.1	15.8	21	22	27				
				•			120	.259	4.2	6.0	8.5	12.0	17.0	19.0	25	27	33				
			•			150	.289	5.3	7.5	10.6	15.0	21	24	31	34	41					
			•			200	.334	7.1	10.0	14.1	20	28	32	42	45	55					
			•			250	.373	8.8	12.5	17.7	25	35	40	52	56	68					

*Maximum pressure for QMVV is 175 psi.

**Maximum pressure for QPTA is 200 psi.

Highlighted column shows the rated pressure.



QUICK VEEJET® AND PROMAX® QUICK VEEJET NOZZLES

S STANDARD ANGLE SPRAY

**FLAT
SPRAY**

DIMENSIONS AND WEIGHTS

Nozzle	Nozzle Type	Inlet Conn. (in.)	L (in.)	Hex. (in.)	W (Width) (in.)	Net Weight (oz.)
	QJJS (M) + QSVV	1/8, 1/4	1.094	9/16	–	1.0
	QJA (F) + QVVA	1/8, 1/4, 3/8, 1/2	2.156	1	–	2.0
	QJJA (M) + QVVA	1/8, 1/4, 3/8, 1/2	2.063	7/8	–	2.8
	QJA (F) + QUA	1/8, 1/4, 3/8, 1/2	2.000	1	–	3.5
	QJJA (M) + QUA	1/8, 1/4, 3/8, 1/2	1.906	7/8	–	3.7
	QJLA (F) + QLUA	3/8, 1/2	2.313	1-1/8	–	4.8
	QJJLA (M) + QLUA	3/8, 1/2	2.313	1-1/8	–	4.8

Based on the largest/heaviest version of each type.

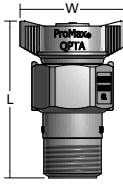
Nozzle	Nozzle Type	Inlet Conn. (in.)	L (in.)	Hex. (in.)	W (Width) (in.)	Net Weight (oz.)
	QPPM (M) + QMVV	1/8, 1/4	1.188	5/8	0.687	0.1
	QPPA (M) + QPTA	1/8, 1/4, 3/8, 1/2	1.750	7/8	1.250	0.4

Based on the largest/heaviest version of each type.

BODY TYPES

Inlet Conn. (in.)	Quick VeeJet and ProMax Quick VeeJet Bodies						
	Conn. F		Conn. M				
	QJA	QJLA	QJJS	QJJA	QJJLA	QPPM	QPPA
1/8	•		•	•		•	•
1/4	•		•	•		•	•
3/8	•	•		•	•		•
1/2	•	•		•	•		•



FLAT
SPRAY

UNIJET® NOZZLES

S STANDARD ANGLE SPRAY

OVERVIEW: UNIJET

- A large choice of interchangeable spray tips, body types/sizes, materials, spray angles, flow rates and accessories allows use of different components in a single header to match performance to different operations
- Save on nozzle replacement costs – bodies can be reused, only spray tips are replaced
- Design allows easy tip change out in place – remove tips by unscrewing the retainer cap
- Recessed orifices to protect against damage
- Flat fan type, tapered edge spray pattern
- Spray angles from 0° to 110°
- Uniform spray distribution with flow rates from .003 to 25 gpm (.013 to 94 lpm)
- Operating pressures up to 500 psi (35 bar)

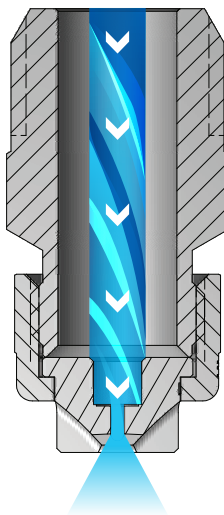

UniJet VeeJet® Nozzles

As the liquid exits through the sharp V shape cut of the orifice, it forms into a flat spray pattern. The distribution is tapered from the center of the spray.

UNIJET OPTIONS

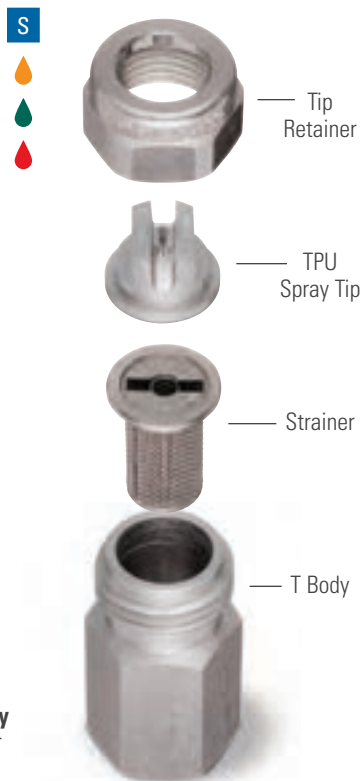

TPU Spray Tip + T Body
Use with screen strainer and tip retainer



TT Body/Cap
1/8" to 1/2" male conn.



T Body/Cap
1/8" to 1/2" female conn.



13802 Spray Tip
Self-aligning tip
Wrench flats on top of tip
Straight alignment flats connection
Use with self-aligning T or TT bodies

RELATIVE DROP SIZE
IN MICRONS

10 to 100	100 to 500	500 to 1000	1000 to 5000
-----------	------------	-------------	--------------

Drop size will vary based on flow rate and pressure.

ORDERING INFORMATION

UNIJET

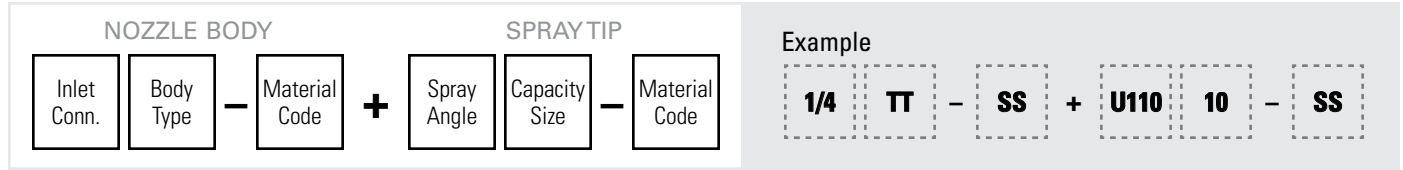

BSPT connections require the addition of a "B" prior to the nozzle body inlet connection.

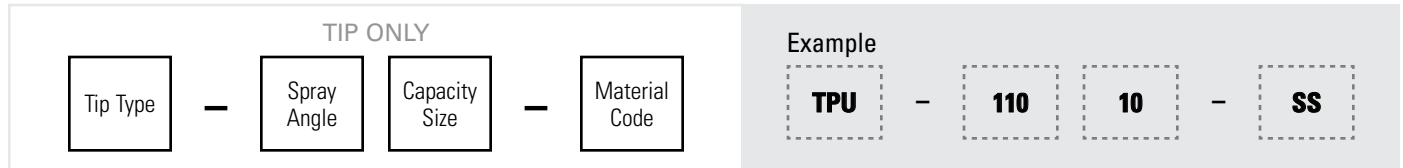

UniJet nozzle assemblies include a pre-sized wire mesh based on orifice diameter. When ordering just a UniJet spray tip, the mesh is not included. See Accessories, page F6 for a mesh selection guide and ordering information.

QUICK REFERENCE GUIDE

Model	Connection	Connection Size (in.)	Materials	Page Number	
				Performance Data	Dimensions and Weights
T body	F	1/8 to 1/2	Brass, 303 stainless steel (SS)	–	C31
TT body	M			–	
TPU spray tip	NA	NA	Brass, 303 stainless steel (SS)	C25–C31	
13802 spray tip	NA	NA	Brass, 303 stainless steel (SS), 316 stainless steel (316 SS)	C25–C31	

F = female thread; M = male thread; NA = not applicable. There is no material code for brass. Leave material code blank when ordering. Other materials available upon request. For more dimensions and sizes, contact your sales engineer.

S PERFORMANCE DATA: STANDARD ANGLE SPRAY

Spray Angle at 40 psi	UniJet Tip Type		Capacity Size	Equiv. Orifice Dia. (in.)	Flow Rate Capacity (gallons per minute)								Spray Angle (°)				
	13802	TPU			5 psi	10 psi	20 psi	40 psi	80 psi	100 psi	200 psi	300 psi	500 psi	20 psi	40 psi	80 psi	200 psi
110°	●	●	0033	.015	–	–	.023	.033	.047	.052	.07	.09	.12	91	110	116	121
	●	●	0050	.018	–	–	.035	.050	.07	.08	.11	.14	.18	91	110	118	124
	●	●	0067	.021	–	–	.05	.067	.09	.11	.15	.18	.24	92	110	118	124
	●	●	01	.026	.035	.05	.07	.10	.14	.16	.22	.27	.35	94	110	121	124
	●	●	015	.032	.05	.08	.11	.15	.21	.24	.34	.41	.53	97	110	121	124
	●	●	02	.035	.07	.10	.14	.20	.28	.32	.45	.55	.71	98	110	120	123
	●	●	03	.043	.11	.15	.21	.30	.42	.47	.67	.82	1.1	99	110	120	123
	●	●	04	.050	.14	.20	.28	.40	.57	.63	.89	1.1	1.4	100	110	119	122
	●	●	05	.056	.18	.25	.35	.50	.71	.79	1.1	1.4	1.8	100	110	118	122

Other body types may be available. Contact your sales engineer for further information.

Highlighted column shows the rated pressure.



**FLAT
SPRAY**

UNIJET® NOZZLES

S STANDARD ANGLE SPRAY

**S PERFORMANCE DATA:
STANDARD ANGLE SPRAY**

Spray Angle at 40 psi	UniJet Tip Type		Capacity Size	Equiv. Orifice Dia. (in.)	Flow Rate Capacity (gallons per minute)									Spray Angle (°)			
	13802	TPU			5 psi	10 psi	20 psi	40 psi	80 psi	100 psi	200 psi	300 psi	500 psi	20 psi	40 psi	80 psi	200 psi
110°	●	●	06	.061	.21	.30	.42	.60	.85	.95	1.3	1.6	2.1	101	110	117	122
	●	●	07	.066	.25	.35	.49	.70	.99	1.1	1.6	1.9	2.5	102	110	117	121
	●	●	08	.071	.28	.40	.57	.80	1.1	1.3	1.8	2.2	2.8	102	110	117	121
	●	●	10	.079	.35	.50	.71	1.0	1.4	1.6	2.2	2.7	3.5	103	110	117	119
	●	●	12	.087	.42	.60	.85	1.2	1.7	1.9	2.7	3.3	4.2	103	110	117	119
	●	●	15	.097	.53	.75	1.1	1.5	2.1	2.4	3.4	4.1	5.3	104	110	117	118
	●	●	20	.112	.71	1.0	1.4	2.0	2.8	3.2	4.5	5.5	7.1	105	110	117	118
	●	●	30	.133	1.1	1.5	2.1	3.0	4.2	4.7	6.7	8.2	10.6	105	110	117	118
95°	●	●	01	.026	.035	.05	.07	.10	.14	.16	.22	.27	.35	81	95	105	113
	●	●	015	.032	.05	.08	.11	.15	.21	.24	.34	.41	.53	82	95	105	113
	●	●	02	.035	.07	.10	.14	.20	.28	.32	.45	.55	.71	82	95	105	113
	●	●	03	.043	.11	.15	.21	.30	.42	.47	.67	.82	1.1	83	95	104	111
	●	●	04	.050	.14	.20	.28	.40	.57	.63	.89	1.1	1.4	84	95	103	108
	●	●	05	.056	.18	.25	.35	.50	.71	.79	1.1	1.4	1.8	84	95	102	107
	●	●	06	.061	.21	.30	.42	.60	.85	.95	1.3	1.6	2.1	86	95	101	106
	●	●	07	.066	.25	.35	.49	.70	.99	1.1	1.6	1.9	2.5	86	95	101	106
	●	●	08	.071	.28	.40	.57	.80	1.1	1.3	1.8	2.2	2.8	87	95	100	105
	●	●	09	.075	.32	.45	.64	.90	1.3	1.4	2.0	2.5	3.2	89	95	100	105
	●	●	10	.079	.35	.50	.71	1.0	1.4	1.6	2.2	2.7	3.5	89	95	100	105
	●	●	11	.083	.39	.55	.78	1.1	1.6	1.7	2.5	3.0	3.9	89	95	100	105
	●	●	12	.087	.42	.60	.85	1.2	1.7	1.9	2.7	3.3	4.2	89	95	100	105
	●	●	13	.090	.46	.65	.92	1.3	1.8	2.1	2.9	3.6	4.6	89	95	100	105
	●	●	14	.093	.49	.70	.99	1.4	2.0	2.2	3.1	3.8	4.9	89	95	100	105
	●	●	15	.097	.53	.75	1.1	1.5	2.1	2.4	3.4	4.1	5.3	90	95	100	105
	●	●	16	.100	.57	.80	1.1	1.6	2.3	2.5	3.6	4.4	5.7	90	95	100	105
	●	●	18	.106	.64	.90	1.3	1.8	2.5	2.8	4.0	4.9	6.4	90	95	100	105
	●	●	20	.112	.71	1.0	1.4	2.0	2.8	3.2	4.5	5.5	7.1	90	95	100	105
	●	●	30	.133	1.1	1.5	2.1	3.0	4.2	4.7	6.7	8.2	10.6	91	95	101	105
●	●	40	.153	1.4	2.0	2.8	4.0	5.7	6.3	8.9	11.0	14.1	92	95	100	105	
●	●	50	.172	1.8	2.5	3.5	5.0	7.1	7.9	11.2	13.7	17.7	93	95	99	103	
●	●	60	.188	2.1	3.0	4.2	6.0	8.5	9.5	13.4	16.4	21	93	95	99	103	
●	●	70	.203	2.5	3.5	4.9	7.0	9.9	11.1	15.7	19.2	25	93	95	99	103	
80°	●	●	0050	.018	–	–	.035	.050	.07	.08	.11	.14	.18	61	80	95	101
	●	●	0067	.021	–	.033	.05	.067	.09	.11	.15	.18	.24	67	80	94	99
	●	●	01	.026	–	.05	.07	.10	.14	.16	.22	.27	.35	68	80	89	92
	●	●	015	.032	–	.08	.11	.15	.21	.24	.34	.41	.53	68	80	89	92
	●	●	02	.035	.07	.10	.14	.20	.28	.32	.45	.55	.71	69	80	88	91
	●	●	03	.043	.11	.15	.21	.30	.42	.47	.67	.82	1.1	70	80	87	90
	●	●	04	.050	.14	.20	.28	.40	.57	.63	.89	1.1	1.4	71	80	86	89
	●	●	045	.053	.16	.23	.32	.45	.64	.71	1.0	1.2	1.6	71	80	86	89
	●	●	05	.056	.18	.25	.35	.50	.71	.79	1.1	1.4	1.8	71	80	86	89
	●	●	06	.061	.21	.30	.42	.60	.85	.95	1.3	1.6	2.1	72	80	85	88

Other body types may be available. Contact your sales engineer for further information.

Highlighted column shows the rated pressure.

S PERFORMANCE DATA:
STANDARD ANGLE SPRAY

Spray Angle at 40 psi	UniJet Tip Type		Capacity Size	Equiv. Orifice Dia. (in.)	Flow Rate Capacity (gallons per minute)									Spray Angle (°)			
	13802	TPU			5 psi	10 psi	20 psi	40 psi	80 psi	100 psi	200 psi	300 psi	500 psi	20 psi	40 psi	80 psi	200 psi
80°	•	•	07	.066	.25	.35	.49	.70	.99	1.1	1.6	1.9	2.5	72	80	85	88
	•	•	08	.071	.28	.40	.57	.80	1.1	1.3	1.8	2.2	2.8	72	80	84	87
	•	•	09	.075	.32	.45	.64	.90	1.3	1.4	2.0	2.5	3.2	73	80	84	87
	•	•	10	.079	.35	.50	.71	1.0	1.4	1.6	2.2	2.7	3.5	73	80	84	87
	•	•	11	.083	.39	.55	.78	1.1	1.6	1.7	2.5	3.0	3.9	73	80	83	86
	•	•	12	.087	.42	.60	.85	1.2	1.7	1.9	2.7	3.3	4.2	73	80	83	86
	•	•	13	.090	.46	.65	.92	1.3	1.8	2.1	2.9	3.6	4.6	73	80	83	86
	•	•	14	.093	.49	.70	.99	1.4	2.0	2.2	3.1	3.8	4.9	73	80	83	86
	•	•	15	.097	.53	.75	1.1	1.5	2.1	2.4	3.4	4.1	5.3	74	80	83	86
	•	•	16	.100	.57	.80	1.1	1.6	2.3	2.5	3.6	4.4	5.7	74	80	83	86
	•	•	17	.103	.60	.85	1.2	1.7	2.4	2.7	3.8	4.7	6.0	74	80	83	86
	•	•	20	.112	.71	1.0	1.4	2.0	2.8	3.2	4.5	5.5	7.1	74	80	83	86
	•	•	25	.121	.88	1.3	1.8	2.5	3.5	4.0	5.6	6.8	8.8	74	80	83	86
	•	•	30	.133	1.1	1.5	2.1	3.0	4.2	4.7	6.7	8.2	10.6	74	80	83	86
	•	•	40	.153	1.4	2.0	2.8	4.0	5.7	6.3	8.9	11.0	14.1	74	80	83	86
	•	•	50	.172	1.8	2.5	3.5	5.0	7.1	7.9	11.2	13.7	17.7	74	80	83	85
	•	•	60	.188	2.1	3.0	4.2	6.0	8.5	9.5	13.4	16.4	21	75	80	83	85
•	•	70	.203	2.5	3.5	4.9	7.0	9.9	11.1	15.7	19.2	25	75	80	83	86	
73°	•	•	0023	.012	–	–	.016	.023	.032	.036	.051	.063	.081	50	73	89	97
	•	•	0039	.016	–	.020	.028	.039	.055	.062	.087	.11	.14	53	73	87	93
	•	•	0077	.023	–	.039	.055	.077	.11	.12	.17	.21	.27	53	73	86	92
	•	•	0116	.028	.041	.058	.082	.12	.16	.18	.26	.32	.41	54	73	85	90
	•	•	0154	.032	.054	.077	.11	.15	.22	.24	.34	.42	.54	55	73	84	88
	•	•	0231	.038	.082	.12	.16	.23	.33	.37	.52	.63	.82	56	73	83	87
	•	•	0308	.044	.11	.15	.22	.31	.44	.49	.69	.84	1.1	58	73	82	86
	•	•	0385	.049	.14	.19	.27	.39	.54	.61	.86	1.1	1.4	59	73	81	85
	•	•	0462	.054	.16	.23	.33	.46	.65	.73	1.0	1.3	1.6	60	73	80	84
	•	•	0616	.062	.22	.31	.44	.62	.87	.97	1.4	1.7	2.2	63	73	79	83
	•	•	0770	.069	.27	.39	.54	.77	1.1	1.2	1.7	2.1	2.7	64	73	77	82
•	•	0924	.076	.33	.46	.65	.92	1.3	1.5	2.1	2.5	3.3	65	73	77	80	
65°	•	•	0017	.011	–	–	.012	.017	.024	.027	.038	.047	.06	44	65	77	86
	•	•	0025	.013	–	–	.018	.025	.035	.040	.06	.07	.09	45	65	77	84
	•	•	0033	.015	–	–	.023	.033	.047	.052	.07	.09	.12	47	65	76	83
	•	•	0050	.018	–	–	.035	.050	.07	.08	.11	.14	.18	48	65	75	82
	•	•	0067	.021	–	.033	.05	.067	.09	.11	.15	.18	.24	50	65	75	81
	•	•	01	.026	–	.05	.07	.10	.14	.16	.22	.27	.35	51	65	74	80
	•	•	015	.032	–	.08	.11	.15	.21	.24	.34	.41	.53	51	65	74	80
	•	•	02	.035	.07	.10	.14	.20	.28	.32	.45	.55	.71	52	65	73	79
	•	•	025	.039	.09	.13	.18	.25	.35	.40	.56	.68	.88	52	65	73	79
	•	•	03	.043	.11	.15	.21	.30	.42	.47	.67	.82	1.1	53	65	72	78
	•	•	035	.047	.12	.18	.25	.35	.49	.55	.78	.96	1.2	53	65	72	78
	•	•	04	.050	.14	.20	.28	.40	.57	.63	.89	1.1	1.4	53	65	72	76

Other body types may be available. Contact your sales engineer for further information.

Highlighted column shows the rated pressure.



**FLAT
SPRAY**

UNIJET® NOZZLES

S STANDARD ANGLE SPRAY

**S PERFORMANCE DATA:
STANDARD ANGLE SPRAY**

Spray Angle at 40 psi	UniJet Tip Type		Capacity Size	Equiv. Orifice Dia. (in.)	Flow Rate Capacity (gallons per minute)									Spray Angle (°)			
	13802	TPU			5 psi	10 psi	20 psi	40 psi	80 psi	100 psi	200 psi	300 psi	500 psi	20 psi	40 psi	80 psi	200 psi
65°	●	●	05	.056	.18	.25	.35	.50	.71	.79	1.1	1.4	1.8	53	65	72	76
	●	●	055	.059	.19	.28	.39	.55	.78	.87	1.2	1.5	1.9	53	65	72	76
	●	●	06	.061	.21	.30	.42	.60	.85	.95	1.3	1.6	2.1	54	65	72	75
	●	●	07	.066	.25	.35	.49	.70	.99	1.1	1.6	1.9	2.5	54	65	72	75
	●	●	08	.071	.28	.40	.57	.80	1.1	1.3	1.8	2.2	2.8	55	65	71	74
	●	●	09	.075	.32	.45	.64	.90	1.3	1.4	2.0	2.5	3.2	55	65	71	74
	●	●	10	.079	.35	.50	.71	1.0	1.4	1.6	2.2	2.7	3.5	56	65	71	74
	●	●	11	.083	.39	.55	.78	1.1	1.6	1.7	2.5	3.0	3.9	56	65	71	74
	●	●	12	.087	.42	.60	.85	1.2	1.7	1.9	2.7	3.3	4.2	56	65	71	74
	●	●	13	.090	.46	.65	.92	1.3	1.8	2.1	2.9	3.6	4.6	56	65	71	74
	●	●	14	.093	.49	.70	.99	1.4	2.0	2.2	3.1	3.8	4.9	56	65	71	74
	●	●	15	.097	.53	.75	1.1	1.5	2.1	2.4	3.4	4.1	5.3	56	65	70	73
	●	●	20	.112	.71	1.0	1.4	2.0	2.8	3.2	4.5	5.5	7.1	57	65	70	73
	●	●	30	.133	1.1	1.5	2.1	3.0	4.2	4.7	6.7	8.2	10.6	58	65	69	72
	●	●	40	.153	1.4	2.0	2.8	4.0	5.7	6.3	8.9	11.0	14.1	59	65	68	72
	●	●	50	.172	1.8	2.5	3.5	5.0	7.1	7.9	11.2	13.7	17.7	60	65	68	71
●	●	60	.188	2.1	3.0	4.2	6.0	8.5	9.5	13.4	16.4	21	60	65	68	71	
●	●	70	.203	2.5	3.5	4.9	7.0	9.9	11.1	15.7	19.2	25	60	65	68	71	
50°	●	●	0017	.011	–	–	.012	.017	.024	.027	.038	.047	.06	27	50	65	74
	●	●	0025	.013	–	–	.018	.025	.035	.040	.06	.07	.09	29	50	64	71
	●	●	0033	.015	–	–	.023	.033	.047	.052	.07	.09	.12	30	50	62	68
	●	●	0050	.018	–	–	.035	.050	.07	.08	.11	.14	.18	32	50	60	66
	●	●	0067	.021	–	–	.05	.067	.09	.11	.15	.18	.24	35	50	60	66
	●	●	01	.026	–	.05	.07	.10	.14	.16	.22	.27	.35	37	50	59	65
	●	●	015	.032	–	.08	.11	.15	.21	.24	.34	.41	.53	38	50	58	64
	●	●	02	.035	–	.10	.14	.20	.28	.32	.45	.55	.71	39	50	57	63
	●	●	025	.039	.09	.13	.18	.25	.35	.40	.56	.68	.88	40	50	57	63
	●	●	03	.043	.11	.15	.21	.30	.42	.47	.67	.82	1.1	40	50	56	62
	●	●	035	.047	.12	.18	.25	.35	.49	.55	.78	.96	1.2	40	50	56	61
	●	●	04	.050	.14	.20	.28	.40	.57	.63	.89	1.1	1.4	42	50	56	61
	●	●	05	.056	.18	.25	.35	.50	.71	.79	1.1	1.4	1.8	44	50	56	61
	●	●	06	.061	.21	.30	.42	.60	.85	.95	1.3	1.6	2.1	45	50	56	60
	●	●	07	.066	.25	.35	.49	.70	.99	1.1	1.6	1.9	2.5	45	50	56	60
	●	●	075	.068	.27	.38	.53	.75	1.1	1.2	1.7	2.1	2.7	45	50	55	60
	●	●	08	.071	.28	.40	.57	.80	1.1	1.3	1.8	2.2	2.8	45	50	55	60
	●	●	09	.075	.32	.45	.64	.90	1.3	1.4	2.0	2.5	3.2	45	50	55	59
	●	●	10	.079	.35	.50	.71	1.0	1.4	1.6	2.2	2.7	3.5	45	50	55	59
	●	●	13	.090	.46	.65	.92	1.3	1.8	2.1	2.9	3.6	4.6	45	50	55	59
●	●	15	.097	.53	.75	1.1	1.5	2.1	2.4	3.4	4.1	5.3	45	50	55	59	
●	●	20	.112	.71	1.0	1.4	2.0	2.8	3.2	4.5	5.5	7.1	45	50	55	59	
●	●	30	.133	1.1	1.5	2.1	3.0	4.2	4.7	6.7	8.2	10.6	45	50	55	59	
●	●	40	.153	1.4	2.0	2.8	4.0	5.7	6.3	8.9	11.0	14.1	46	50	54	59	

Other body types may be available. Contact your sales engineer for further information.

Highlighted column shows the rated pressure.



**S PERFORMANCE DATA:
STANDARD ANGLE SPRAY**

Spray Angle at 40 psi	UniJet Tip Type		Capacity Size	Equiv. Orifice Dia. (in.)	Flow Rate Capacity (gallons per minute)									Spray Angle (°)			
	13802	TPU			5 psi	10 psi	20 psi	40 psi	80 psi	100 psi	200 psi	300 psi	500 psi	20 psi	40 psi	80 psi	200 psi
50°	●	●	50	.172	1.8	2.5	3.5	5.0	7.1	7.9	11.2	13.7	17.7	46	50	54	59
	●	●	60	.188	2.1	3.0	4.2	6.0	8.5	9.5	13.4	16.4	21	46	50	54	59
	●	●	70	.203	2.5	3.5	4.9	7.0	9.9	11.1	15.7	19.2	25	46	50	54	59
40°	●	●	0017	.011	–	–	.012	.017	.024	.027	.038	.047	.06	21	40	54	61
	●	●	0025	.013	–	–	.018	.025	.035	.040	.06	.07	.09	22	40	53	60
	●	●	0033	.015	–	–	.023	.033	.047	.052	.07	.09	.12	22	40	53	60
	●	●	0050	.018	–	–	.035	.050	.07	.08	.11	.14	.18	22	40	53	60
	●	●	0067	.021	–	–	.05	.067	.09	.11	.15	.18	.24	24	40	53	60
	●	●	01	.026	–	–	.07	.10	.14	.16	.22	.27	.35	26	40	52	59
	●	●	015	.032	–	–	.11	.15	.21	.24	.34	.41	.53	27	40	52	59
	●	●	02	.035	–	.10	.14	.20	.28	.32	.45	.55	.71	29	40	51	58
	●	●	025	.039	–	.13	.18	.25	.35	.40	.56	.68	.88	29	40	51	58
	●	●	03	.043	–	.15	.21	.30	.42	.47	.67	.82	1.1	30	40	50	57
	●	●	04	.050	–	.20	.28	.40	.57	.63	.89	1.1	1.4	30	40	50	56
	●	●	05	.056	–	.25	.35	.50	.71	.79	1.1	1.4	1.8	31	40	49	55
	●	●	055	.059	–	.28	.39	.55	.78	.87	1.2	1.5	1.9	31	40	49	55
	●	●	06	.061	–	.30	.42	.60	.85	.95	1.3	1.6	2.1	31	40	49	55
	●	●	07	.066	.25	.35	.49	.70	.99	1.1	1.6	1.9	2.5	31	40	49	55
	●	●	08	.071	.28	.40	.57	.80	1.1	1.3	1.8	2.2	2.8	31	40	47	53
	●	●	09	.075	.32	.45	.64	.90	1.3	1.4	2.0	2.5	3.2	32	40	45	48
	●	●	10	.079	.35	.50	.71	1.0	1.4	1.6	2.2	2.7	3.5	32	40	45	48
	●	●	11	.083	.39	.55	.78	1.1	1.6	1.7	2.5	3.0	3.9	32	40	45	48
	●	●	12	.087	.42	.60	.85	1.2	1.7	1.9	2.7	3.3	4.2	32	40	45	48
	●	●	13	.090	.46	.65	.92	1.3	1.8	2.1	2.9	3.6	4.6	32	40	45	48
	●	●	15	.097	.53	.75	1.1	1.5	2.1	2.4	3.4	4.1	5.3	32	40	45	48
	●	●	20	.112	.71	1.0	1.4	2.0	2.8	3.2	4.5	5.5	7.1	32	40	45	48
	●	●	25	.121	.88	1.3	1.8	2.5	3.5	4.0	5.6	6.8	8.8	32	40	45	48
	●	●	30	.133	1.1	1.5	2.1	3.0	4.2	4.7	6.7	8.2	10.6	33	40	45	48
	●	●	40	.153	1.4	2.0	2.8	4.0	5.7	6.3	8.9	11.0	14.1	34	40	45	48
	●	●	50	.172	1.8	2.5	3.5	5.0	7.1	7.9	11.2	13.7	17.7	35	40	45	48
	●	●	60	.188	2.1	3.0	4.2	6.0	8.5	9.5	13.4	16.4	21	35	40	45	48
●	●	70	.203	2.5	3.5	4.9	7.0	9.9	11.1	15.7	19.2	25	35	40	45	48	
25°	●	●	0017	.011	–	–	–	.017	.024	.027	.038	.047	.06	–	25	35	47
	●	●	0025	.013	–	–	–	.025	.035	.040	.06	.07	.09	–	25	35	45
	●	●	0033	.015	–	–	–	.033	.047	.052	.07	.09	.12	–	25	34	44
	●	●	0050	.018	–	–	–	.050	.07	.08	.11	.14	.18	–	25	34	43
	●	●	0067	.021	–	–	–	.067	.09	.11	.15	.18	.24	–	25	34	42
	●	●	01	.026	–	–	.07	.10	.14	.16	.22	.27	.35	14	25	34	42
	●	●	015	.032	–	–	.11	.15	.21	.24	.34	.41	.53	15	25	34	41
	●	●	02	.035	–	–	.14	.20	.28	.32	.45	.55	.71	15	25	33	40
	●	●	03	.043	–	–	.21	.30	.42	.47	.67	.82	1.1	15	25	33	40
	●	●	04	.050	–	.20	.28	.40	.57	.63	.89	1.1	1.4	16	25	32	39

Other body types may be available. Contact your sales engineer for further information.

Highlighted column shows the rated pressure.



FLAT
SPRAY

UNIJET® NOZZLES

S STANDARD ANGLE SPRAY

S PERFORMANCE DATA:
STANDARD ANGLE SPRAY

Spray Angle at 40 psi	UniJet Tip Type		Capacity Size	Equiv. Orifice Dia. (in.)	Flow Rate Capacity (gallons per minute)									Spray Angle (°)			
	13802	TPU			5 psi	10 psi	20 psi	40 psi	80 psi	100 psi	200 psi	300 psi	500 psi	20 psi	40 psi	80 psi	200 psi
25°	●	●	05	.056	–	.25	.35	.50	.71	.79	1.1	1.4	1.8	16	25	32	39
	●	●	055	.059	–	.28	.39	.55	.78	.87	1.2	1.5	1.9	16	25	32	39
	●	●	06	.061	–	.30	.42	.60	.85	.95	1.3	1.6	2.1	17	25	31	38
	●	●	07	.066	–	.35	.49	.70	.99	1.1	1.6	1.9	2.5	17	25	31	38
	●	●	08	.071	–	.40	.57	.80	1.1	1.3	1.8	2.2	2.8	17	25	31	38
	●	●	09	.075	–	.45	.64	.90	1.3	1.4	2.0	2.5	3.2	17	25	31	38
	●	●	10	.079	–	.50	.71	1.0	1.4	1.6	2.2	2.7	3.5	18	25	31	37
	●	●	13	.090	–	.65	.92	1.3	1.8	2.1	2.9	3.6	4.6	18	25	31	37
	●	●	15	.097	–	.75	1.1	1.5	2.1	2.4	3.4	4.1	5.3	18	25	31	37
	●	●	20	.112	–	1.0	1.4	2.0	2.8	3.2	4.5	5.5	7.1	19	25	31	37
	●	●	30	.133	1.1	1.5	2.1	3.0	4.2	4.7	6.7	8.2	10.6	20	25	30	36
	●	●	40	.153	1.4	2.0	2.8	4.0	5.7	6.3	8.9	11.0	14.1	21	25	29	35
	●	●	50	.172	1.8	2.5	3.5	5.0	7.1	7.9	11.2	13.7	17.7	21	25	29	35
	●	●	60	.188	2.1	3.0	4.2	6.0	8.5	9.5	13.4	16.4	21	22	25	29	35
●	●	70	.203	2.5	3.5	4.9	7.0	9.9	11.1	15.7	19.2	25	22	25	29	35	
15°	●	●	0017	.011	–	–	–	.017	.024	.027	.038	.047	.06	–	15	30	37
	●	●	0025	.013	–	–	–	.025	.035	.040	.06	.07	.09	–	15	28	34
	●	●	0033	.015	–	–	–	.033	.047	.052	.07	.09	.12	–	15	27	32
	●	●	0050	.018	–	–	–	.050	.07	.08	.11	.14	.18	–	15	26	30
	●	●	0067	.021	–	–	–	.067	.09	.11	.15	.18	.24	–	15	25	29
	●	●	01	.026	–	–	–	.10	.14	.16	.22	.27	.35	–	15	24	28
	●	●	015	.032	–	–	–	.15	.21	.24	.34	.41	.53	–	15	23	27
	●	●	02	.035	–	–	.14	.20	.28	.32	.45	.55	.71	6	15	22	27
	●	●	03	.043	–	–	.21	.30	.42	.47	.67	.82	1.1	6	15	22	27
	●	●	04	.050	–	–	.28	.40	.57	.63	.89	1.1	1.4	7	15	21	26
	●	●	05	.056	–	–	.35	.50	.71	.79	1.1	1.4	1.8	7	15	21	26
	●	●	055	.059	–	–	.39	.55	.78	.87	1.2	1.5	1.9	7	15	21	26
	●	●	06	.061	–	–	.42	.60	.85	.95	1.3	1.6	2.1	8	15	21	26
	●	●	07	.066	–	–	.49	.70	.99	1.1	1.6	1.9	2.5	8	15	21	26
	●	●	08	.071	–	–	.57	.80	1.1	1.3	1.8	2.2	2.8	9	15	20	25
	●	●	09	.075	–	–	.64	.90	1.3	1.4	2.0	2.5	3.2	9	15	20	25
	●	●	10	.079	–	–	.71	1.0	1.4	1.6	2.2	2.7	3.5	10	15	19	24
	●	●	11	.083	–	.55	.78	1.1	1.6	1.7	2.5	3.0	3.9	10	15	19	24
	●	●	12	.087	.42	.60	.85	1.2	1.7	1.9	2.7	3.3	4.2	10	15	19	24
	●	●	15	.097	.53	.75	1.1	1.5	2.1	2.4	3.4	4.1	5.3	10	15	19	24
	●	●	20	.112	.71	1.0	1.4	2.0	2.8	3.2	4.5	5.5	7.1	10	15	19	23
	●	●	30	.133	1.1	1.5	2.1	3.0	4.2	4.7	6.7	8.2	10.6	10	15	19	21
	●	●	40	.153	1.4	2.0	2.8	4.0	5.7	6.3	8.9	11.0	14.1	10	15	18	21
	●	●	50	.172	1.8	2.5	3.5	5.0	7.1	7.9	11.2	13.7	17.7	11	15	18	21
●	●	60	.188	2.1	3.0	4.2	6.0	8.5	9.5	13.4	16.4	21	11	15	18	21	
●	●	70	.203	2.5	3.5	4.9	7.0	9.9	11.1	15.7	19.2	25	11	15	18	21	

Other body types may be available. Contact your sales engineer for further information.

Highlighted column shows the rated pressure.



S PERFORMANCE DATA:
STANDARD ANGLE SPRAY

Spray Angle at 40 psi	UniJet Tip Type		Capacity Size	Equiv. Orifice Dia. (in.)	Flow Rate Capacity (gallons per minute)									Spray Angle (°)			
	13802	TPU			5 psi	10 psi	20 psi	40 psi	80 psi	100 psi	200 psi	300 psi	500 psi	20 psi	40 psi	80 psi	200 psi
0°		●	0009	.008	.003	.003	.005	.009	.013	.014	.020	.025	.032	0 Solid Stream			
		●	0012	.010	.004	.006	.008	.012	.017	.019	.027	.033	.042				
		●	0019	.012	.007	.009	.013	.019	.027	.030	.043	.052	.067				
		●	0021	.013	.007	.010	.011	.023	.033	.040	.047	.052	.074				
		●	0033	.016	.01	.02	.023	.033	.047	.052	.07	.09	.12				
		●	0050	.019	.018	.025	.035	.050	.07	.08	.11	.14	.18				
		●	0067	.023	.024	.033	.05	.067	.09	.11	.15	.18	.24				
		●	01	.028	.035	.05	.07	.10	.14	.16	.22	.27	.35				
		●	015	.034	.05	.08	.11	.15	.21	.24	.34	.41	.53				
		●	02	.039	.07	.10	.14	.20	.28	.32	.45	.55	.71				
		●	03	.041	.11	.15	.21	.30	.42	.47	.67	.82	1.1				
		●	04	.047	.14	.20	.28	.40	.57	.63	.89	1.1	1.4				
		●	045	.052	.16	.23	.32	.45	.64	.71	1.0	1.2	1.6				
		●	05	.053	.18	.25	.35	.50	.71	.79	1.1	1.4	1.8				
		●	055	.055	.19	.28	.39	.55	.78	.87	1.2	1.5	1.9				
		●	06	.058	.21	.30	.42	.60	.85	.95	1.3	1.6	2.1				
		●	065	.060	.23	.33	.46	.65	.92	1.0	1.5	1.8	2.3				
		●	07	.062	.25	.35	.49	.70	.99	1.1	1.6	1.9	2.5				
		●	08	.067	.28	.40	.57	.80	1.1	1.3	1.8	2.2	2.8				
		●	09	.071	.32	.45	.64	.90	1.3	1.4	2.0	2.5	3.2				
	●	10	.075	.35	.50	.71	1.0	1.4	1.6	2.2	2.7	3.5					
	●	11	.079	.39	.55	.78	1.1	1.6	1.7	2.5	3.0	3.9					
	●	12	.082	.42	.60	.85	1.2	1.7	1.9	2.7	3.3	4.2					
	●	15	.091	.53	.75	1.1	1.5	2.1	2.4	3.4	4.1	5.3					
	●	20	.106	.71	1.0	1.4	2.0	2.8	3.2	4.5	5.5	7.1					
	●	30	.129	1.1	1.5	2.1	3.0	4.2	4.7	6.7	8.2	10.6					
	●	40	.149	1.4	2.0	2.8	4.0	5.7	6.3	8.9	11.0	14.1					

Other body types may be available. Contact your sales engineer for further information.

Highlighted column shows the rated pressure.

DIMENSIONS AND WEIGHTS

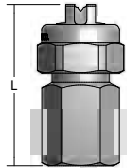
Nozzle	Nozzle Type	Inlet Conn. (in.)	L (in.)	Hex. (in.)	Net Weight (oz.)
	T (F) + TPU TT (M) + TPU	1/4	1.610	13/16	2.3

Based on the largest/heaviest version of each type.

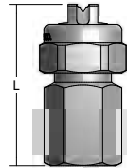
Nozzle	Nozzle Type	Inlet Conn. (in.)	L (in.)	Hex. (in.)	Net Weight (oz.)
	T (F) + 13802 TT (M) + 13802	1/4	1.891	13/16	2.3

Based on the largest/heaviest version of each type.



FLAT
SPRAY

WASHJET® NOZZLES

S HIGH IMPACT STANDARD ANGLE SPRAY

OVERVIEW: WASHJET

- High-impact sprays and high pressure operation ensure optimal cleaning – ideal for pressure washing
 - Long wear life – 400 series stainless steel material
 - Flat spray nozzles provide an even edge fan type spray pattern
 - Uniform spray distribution from .27 to 78 gpm (1.0 to 290 lpm) by using optional internal guide vane to stabilize liquid turbulence
 - Spray angles from 0° (solid stream) to 65° for MEG, WEG and MEG-SSTC; 0° to 80° for IMEG
 - Operating pressures from 300 to 4000 psi (20 to 275 bar)
 - MEG-SSTC nozzles have tungsten carbide orifice inserts for maximum erosion resistance
 - IMEG® versions are ideal for critical, demanding operations
- Features:
- Patented design that optimizes fluid dynamics by minimizing turbulence
 - Higher impact per unit area than MEG nozzles

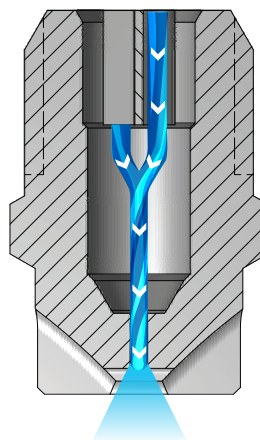

WashJet Nozzles
As the liquid exits through the rounded U shape of the orifice, it forms into a flat spray pattern. The distribution is even at pressures above 300 psi (20 bar).

WASHJET OPTIONS

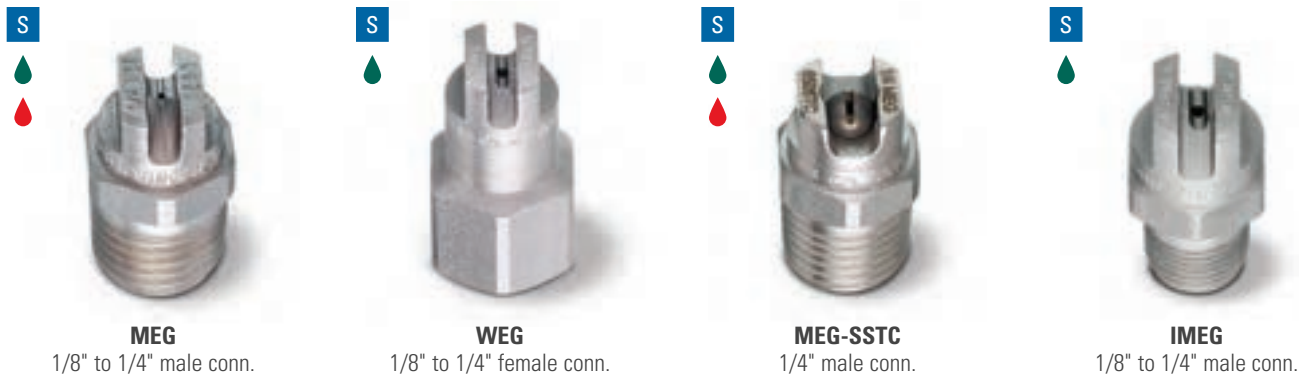

ORDERING INFORMATION

WASHJET MEG, WEG, MEG-SSTC AND IMEG WITH GUIDE VANE

Inlet Conn.	Nozzle Type	–	Spray Angle	Capacity Size	Example
					1/4 MEG – 15 04

BSPT connections require the addition of a "B" prior to the inlet connection.

WASHJET MEG, WEG, MEG-SSTC AND IMEG WITHOUT GUIDE VANE

Inlet Conn.	Nozzle Type	–	Spray Angle	Capacity Size	Example
					1/4 SAMEG – 15 04

BSPT connections require the addition of a "B" prior to the inlet connection.

WASHJET® NOZZLES

S HIGH IMPACT STANDARD ANGLE SPRAY

FLAT
SPRAY

OVERVIEW: QUICK-CONNECT WASHJET

- QCMEG and QCIMEG fit in Parker® ST fitting or equivalent
- Color-coded nozzle guards for easy spray angle identification
- Locating ribs on nozzle guards for fast alignment and easy spray pattern direction
- High impact sprays and high pressure operation ensure effective cleaning
- Long wear life – 400 series stainless steel material
- Uniform spray distribution from .55 to 15 gpm (2.0 to 57 lpm) by using optional internal guide vane to stabilize liquid turbulence
- Spray angles from 0° (solid stream) to 40°
- QCIMEG versions are ideal for critical, demanding operations. Features:
 - Patented design that optimizes fluid dynamics by minimizing turbulence
 - Higher impact per unit area than QCMEG nozzles

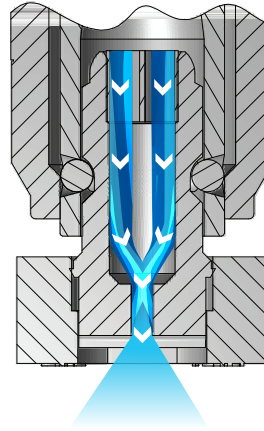

Quick-Connect WashJet Nozzles

As the liquid exits through the rounded U shape of the orifice, it forms into a flat spray pattern. The distribution is even at pressures above 300 psi (20 bar).

QUICK-CONNECT WASHJET OPTIONS



QCMEG
1/4" quick-connect



QCIMEG
1/4" quick-connect

ORDERING INFORMATION

QUICK-CONNECT WASHJET QCMEG AND QCIMEG WITH GUIDE VANE

Nozzle Type	—	Spray Angle	Capacity Size	Example
				QCMEG — 15 05

QUICK-CONNECT WASHJET QCMEG AND QCIMEG WITHOUT GUIDE VANE

Nozzle Type	—	Spray Angle	Capacity Size	Example
				SAQCMEG — 15 05

RELATIVE DROP SIZE IN MICRONS

10 to 100	100 to 500	500 to 1000	1000 to 5000
-----------	------------	-------------	--------------

Drop size will vary based on flow rate and pressure.

**FLAT
SPRAY**

WASHJET® NOZZLES

S HIGH IMPACT STANDARD ANGLE SPRAY

QUICK REFERENCE GUIDE

Model	Connection	Connection Size (in.)	Materials	Page Number	
				Performance Data	Dimensions and Weights
MEG	M	1/8 to 1/4	Hardened stainless steel	C34–C35	C37
WEG	F	1/8 to 1/4		C35	
MEG-SSTC	M	1/4		C34–C35	
IMEG®	M	1/8 to 1/4		C36	
QCMEG	NA	NA		C36	
QCIMEG	NA	NA		C37	

F = female thread; M = male thread; NA = not applicable. Material is built into part number for ordering. For more dimensions and sizes, contact your sales engineer.

**S PERFORMANCE DATA:
STANDARD ANGLE SPRAY**



Nozzle Type and Spray Angle																	Capacity Size	Flow Rate Capacity (gallons per minute)													
1/8 MEG					1/4 MEG					1/4 MEG-SSTC								40 psi	300 psi	500 psi	750 psi	1000 psi	1500 psi	2000 psi	2500 psi	3000 psi					
0°*	5°	15°	25°	40°	50°	65°	0°*	5°	15°	25°	40°	50°	65°	0°*	5°	15°		25°	40°	50°	65°										
									•					•		•				•		01	.10	.27	.35	.43	.50	.61	.71	.79	.87
									•													015	.15	.41	.53	.65	.75	.92	1.1	1.2	1.3
•	•	•	•	•			•	•	•	•	•			•	•	•		•	•	•		02	.20	.55	.71	.87	1.0	1.2	1.4	1.6	1.7
														•								025	.25	.68	.88	1.1	1.3	1.5	1.8	2.0	2.2
•		•	•	•	•		•	•	•	•	•	•	•	•	•		•			•	•	03	.30	.82	1.1	1.3	1.5	1.8	2.1	2.4	2.6
							•		•	•	•											035	.35	.96	1.2	1.5	1.8	2.1	2.5	2.8	3.0
•		•	•	•	•	•	•	•	•	•	•	•	•	•	•		•	•		•	•	04	.40	1.1	1.4	1.7	2.0	2.4	2.8	3.2	3.5
•		•	•	•	•	•	•	•	•	•	•	•	•	•	•		•	•		•	•	045	.45	1.2	1.6	1.9	2.3	2.8	3.2	3.6	3.9
•	•	•	•	•	•	•	•	•	•	•	•	•	•	•	•		•	•	•	•		05	.50	1.4	1.8	2.2	2.5	3.1	3.5	4.0	4.3
•		•	•	•	•	•	•	•	•	•	•	•	•	•	•		•	•		•		055	.55	1.5	1.9	2.4	2.8	3.4	3.9	4.3	4.8
•	•	•	•	•	•	•	•	•	•	•	•	•	•	•	•		•	•	•			06	.60	1.6	2.1	2.6	3.0	3.7	4.2	4.7	5.2
•		•	•	•	•		•		•	•	•	•	•									065	.65	1.8	2.3	2.8	3.3	4.0	4.6	5.1	5.6
•	•	•	•	•	•	•	•	•	•	•	•	•	•	•	•		•	•	•	•		07	.70	1.9	2.5	3.0	3.5	4.3	4.9	5.5	6.1
•		•	•	•	•		•		•	•	•	•										075	.75	2.1	2.7	3.2	3.8	4.6	5.3	5.9	6.5
•		•	•	•	•	•	•	•	•	•	•	•	•	•	•		•	•	•		•	08	.80	2.2	2.8	3.5	4.0	4.9	5.7	6.3	6.9
•		•	•	•	•		•		•	•	•											085	.85	2.3	3.0	3.7	4.3	5.2	6.0	6.7	7.4
•		•	•	•	•	•	•	•	•	•	•	•	•	•	•		•	•	•		•	09	.90	2.5	3.2	3.9	4.5	5.5	6.4	7.1	7.8
		•	•				•			•												095	.95	2.6	3.4	4.1	4.8	5.8	6.7	7.5	8.2
•		•	•	•	•	•	•		•	•	•	•	•	•	•		•	•				10	1.0	2.7	3.5	4.3	5.0	6.1	7.1	7.9	8.7
•			•				•		•	•	•											11	1.1	3.0	3.9	4.8	5.5	6.7	7.8	8.7	9.5
•		•	•																			115	1.2	3.1	4.1	5.0	5.8	7.0	8.1	9.1	10.0
•				•			•	•	•	•	•	•	•	•	•		•					12	1.2	3.3	4.2	5.2	6.0	7.3	8.5	9.5	10.4
•							•		•	•	•											125	1.3	3.4	4.4	5.4	6.3	7.7	8.8	9.9	10.8

*0° = Solid Stream.
Highlighted column shows the rated pressure.

S PERFORMANCE DATA: STANDARD ANGLE SPRAY

Nozzle Type and Spray Angle																	Capacity Size	Flow Rate Capacity (gallons per minute)													
1/8 MEG					1/4 MEG					1/4 MEG-SSTC								40 psi	300 psi	500 psi	750 psi	1000 psi	1500 psi	2000 psi	2500 psi	3000 psi					
0°*	5°	15°	25°	40°	50°	65°	0°*	5°	15°	25°	40°	50°	65°	0°*	5°	15°	25°	40°	50°	65°											
•							•		•	•	•											13	1.3	3.6	4.6	5.6	6.5	8.0	9.2	10.3	11.3
	•								•	•												14	1.4	3.8	4.9	6.1	7.0	8.6	9.9	11.1	12.1
•		•	•				•	•	•	•	•	•	•	•		•		•		•		15	1.5	4.1	5.3	6.5	7.5	9.2	10.6	11.9	13.0
		•					•		•													16	1.6	4.4	5.7	6.9	8.0	9.8	11.3	12.6	13.9
							•		•	•	•				•							18	1.8	4.9	6.4	7.8	9.0	11.0	12.7	14.2	15.6
•							•	•	•	•	•	•	•	•								20	2.0	5.5	7.1	8.7	10.0	12.2	14.1	15.8	17.3
							•	•	•	•	•											25	2.5	6.8	8.8	10.8	12.5	15.3	17.7	19.8	22
							•	•	•	•	•		•									30	3.0	8.2	10.6	13.0	15.0	18.4	21	24	26
							•		•	•	•											35	3.5	9.6	12.4	15.2	17.5	21	25	28	30
							•	•	•	•	•											40	4.0	11.0	14.1	17.3	20	24	28	32	35
							•		•	•	•											50	5.0	13.7	17.7	22	25	31	35	40	43
							•		•	•	•											60	6.0	16.4	21	26	30	37	42	47	52
							•															70	7.0	19.2	25	30	35	43	49	55	61
							•															80	8.0	22	28	35	40	49	57	63	69
							•															90	9.0	25	32	39	45	55	64	71	78

*0° = Solid Stream.

Highlighted column shows the rated pressure.

S PERFORMANCE DATA: STANDARD ANGLE SPRAY

Nozzle Type and Spray Angle														Capacity Size	Flow Rate Capacity (gallons per minute)																	
1/8 WEG							1/4 WEG								40 psi	300 psi	500 psi	750 psi	1000 psi	1500 psi	2000 psi	2500 psi	3000 psi									
0°*	5°	15°	25°	40°	50°	65°	0°*	5°	15°	25°	40°	50°	65°																			
		•	•	•											03	.30	.82	1.1	1.3	1.5	1.8	2.1	2.4	2.6								
•		•	•	•	•	•	•		•	•	•		•		04	.40	1.1	1.4	1.7	2.0	2.4	2.8	3.2	3.5								
		•	•	•					•	•	•				045	.45	1.2	1.6	1.9	2.3	2.8	3.2	3.6	3.9								
•		•	•	•	•	•	•		•	•	•		•		05	.50	1.4	1.8	2.2	2.5	3.1	3.5	4.0	4.3								
•		•	•	•	•	•	•		•	•					055	.55	1.5	1.9	2.4	2.8	3.4	3.9	4.3	4.8								
•		•	•	•	•	•	•		•	•	•				06	.60	1.6	2.1	2.6	3.0	3.7	4.2	4.7	5.2								
				•					•						065	.65	1.8	2.3	2.8	3.3	4.0	4.6	5.1	5.6								
•		•	•	•	•	•	•		•	•	•		•		07	.70	1.9	2.5	3.0	3.5	4.3	4.9	5.5	6.1								
•		•	•	•	•	•	•		•	•	•				08	.80	2.2	2.8	3.5	4.0	4.9	5.7	6.3	6.9								
•		•	•	•											085	.85	2.3	3.0	3.7	4.3	5.2	6.0	6.7	7.4								
•		•	•	•	•	•	•		•	•	•				09	.90	2.5	3.2	3.9	4.5	5.5	6.4	7.1	7.8								
			•												095	.95	2.6	3.4	4.1	4.8	5.8	6.7	7.5	8.2								
•		•	•	•	•	•	•		•	•	•				10	1.0	2.7	3.5	4.3	5.0	6.1	7.1	7.9	8.7								
							•								15	1.5	4.1	5.3	6.5	7.5	9.2	10.6	11.9	13.0								
		•													16	1.6	4.4	5.7	6.9	8.0	9.8	11.3	12.6	13.9								
•															20	2.0	5.5	7.1	8.7	10.0	12.2	14.1	15.8	17.3								
							•								30	3.0	8.2	10.6	13.0	15.0	18.4	21	24	26								

*0° = Solid Stream.

Highlighted column shows the rated pressure.



**FLAT
SPRAY**

WASHJET® NOZZLES

S HIGH IMPACT STANDARD ANGLE SPRAY

**S PERFORMANCE DATA:
STANDARD ANGLE SPRAY**

Inlet Conn. (in.)	Nozzle Type	Spray Angle at 40 psi								Capacity Size	Flow Rate Capacity (gallons per minute)											
		IMEG®	5°	10°	15°	25°	40°	50°	65°		80°	40 psi	300 psi	500 psi	750 psi	1000 psi	1500 psi	2000 psi	2500 psi	3000 psi	3500 psi	4000 psi
1/8, 1/4	●	●	●	●	●	●	●	●	●	●	03	.30	.82	1.1	1.3	1.5	1.8	2.1	2.4	2.6	2.8	3.0
	●	●	●	●	●	●	●	●	●	●	035	.35	.96	1.2	1.5	1.8	2.1	2.5	2.8	3.0	3.3	3.5
	●	●	●	●	●	●	●	●	●	●	04	.40	1.1	1.4	1.7	2.0	2.4	2.8	3.2	3.5	3.7	4.0
	●	●	●	●	●	●	●	●	●	●	045	.45	1.2	1.6	1.9	2.3	2.8	3.2	3.6	3.9	4.2	4.5
	●	●	●	●	●	●	●	●	●	●	05	.50	1.4	1.8	2.2	2.5	3.1	3.5	4.0	4.3	4.7	5.0
	●	●	●	●	●	●	●	●	●	●	055	.55	1.5	1.9	2.4	2.8	3.4	3.9	4.3	4.8	5.1	5.5
	●	●	●	●	●	●	●	●	●	●	06	.60	1.6	2.1	2.6	3.0	3.7	4.2	4.7	5.2	5.6	6.0
	●	●	●	●	●	●	●	●	●	●	065	.65	1.8	2.3	2.8	3.3	4.0	4.6	5.1	5.6	6.1	6.5
	●	●	●	●	●	●	●	●	●	●	07	.70	1.9	2.5	3.0	3.5	4.3	4.9	5.5	6.1	6.5	7.0
	●	●	●	●	●	●	●	●	●	●	075	.75	2.1	2.7	3.2	3.8	4.6	5.3	5.9	6.5	7.0	7.5
●	●	●	●	●	●	●	●	●	●	08	.80	2.2	2.8	3.5	4.0	4.9	5.7	6.3	6.9	7.5	8.0	

Highlighted column shows the rated pressure.

**S PERFORMANCE DATA:
STANDARD ANGLE SPRAY**

Nozzle Type	Spray Angle at 40 psi				Capacity Size	Flow Rate Capacity (gallons per minute)										
	QCMEG	0°* (Red)	15° (Yellow)	25° (Green)		40° (White)	40 psi	300 psi	500 psi	750 psi	1000 psi	1500 psi	2000 psi	2500 psi	3000 psi	3500 psi
●			●	●	02	.20	.55	.71	.87	1.0	1.2	1.4	1.6	1.7	1.9	2.0
●	●	●	●		03	.30	.82	1.1	1.3	1.5	1.8	2.1	2.4	2.6	2.8	3.0
●	●	●	●	●	035	.35	.96	1.2	1.5	1.8	2.1	2.5	2.8	3.0	3.3	3.5
●	●	●	●	●	04	.40	1.1	1.4	1.7	2.0	2.4	2.8	3.2	3.5	3.7	4.0
●	●	●	●	●	045	.45	1.2	1.6	1.9	2.3	2.8	3.2	3.6	3.9	4.2	4.5
●	●	●	●	●	05	.50	1.4	1.8	2.2	2.5	3.1	3.5	4.0	4.3	4.7	5.0
●	●	●	●	●	055	.55	1.5	1.9	2.4	2.8	3.4	3.9	4.3	4.8	5.1	5.5
●	●	●	●	●	06	.60	1.6	2.1	2.6	3.0	3.7	4.2	4.7	5.2	5.6	6.0
●	●	●	●	●	065	.65	1.8	2.3	2.8	3.3	4.0	4.6	5.1	5.6	6.1	6.5
●	●	●	●	●	07	.70	1.9	2.5	3.0	3.5	4.3	4.9	5.5	6.1	6.5	7.0
●	●	●	●	●	075	.75	2.1	2.7	3.2	3.8	4.6	5.3	5.9	6.5	7.0	7.5
●	●	●	●	●	08	.80	2.2	2.8	3.5	4.0	4.9	5.7	6.3	6.9	7.5	8.0
●		●	●	●	09	.90	2.5	3.2	3.9	4.5	5.5	6.4	7.1	7.8	8.4	9.0
●	●	●	●	●	10	1.0	2.7	3.5	4.3	5.0	6.1	7.1	7.9	8.7	9.4	10.0
●	●	●	●	●	12	1.2	3.3	4.2	5.2	6.0	7.3	8.5	9.5	10.4	11.2	12.0
●		●		●	15	1.5	4.1	5.3	6.5	7.5	9.2	10.6	11.9	13.0	14.0	15.0

*0° = Solid Stream.

Highlighted column shows the rated pressure.



S PERFORMANCE DATA:
STANDARD ANGLE SPRAY

Nozzle Type	Spray Angle at 40 psi				Capacity Size	Flow Rate Capacity (gallons per minute)											
	10° (Orange)	15° (Yellow)	25° (Green)	40° (White)		40 psi	300 psi	500 psi	750 psi	1000 psi	1500 psi	2000 psi	2500 psi	3000 psi	3500 psi	4000 psi	
●			●	●	02	.20	.55	.71	.87	1.0	1.2	1.4	1.6	1.7	1.9	2.0	
●	●	●	●	●	03	.30	.82	1.1	1.3	1.5	1.8	2.1	2.4	2.6	2.8	3.0	
●	●	●	●	●	035	.35	.96	1.2	1.5	1.8	2.1	2.5	2.8	3.0	3.3	3.5	
●	●	●	●	●	04	.40	1.1	1.4	1.7	2.0	2.4	2.8	3.2	3.5	3.7	4.0	
●	●	●	●	●	045	.45	1.2	1.6	1.9	2.3	2.8	3.2	3.6	3.9	4.2	4.5	
●	●	●	●	●	05	.50	1.4	1.8	2.2	2.5	3.1	3.5	4.0	4.3	4.7	5.0	
●	●	●	●	●	055	.55	1.5	1.9	2.4	2.8	3.4	3.9	4.3	4.8	5.1	5.5	
●	●	●	●	●	06	.60	1.6	2.1	2.6	3.0	3.7	4.2	4.7	5.2	5.6	6.0	
●	●	●	●	●	065	.65	1.8	2.3	2.8	3.3	4.0	4.6	5.1	5.6	6.1	6.5	
●	●	●	●	●	07	.70	1.9	2.5	3.0	3.5	4.3	4.9	5.5	6.1	6.5	7.0	
●	●	●	●	●	075	.75	2.1	2.7	3.2	3.8	4.6	5.3	5.9	6.5	7.0	7.5	
●	●	●	●	●	08	.80	2.2	2.8	3.5	4.0	4.9	5.7	6.3	6.9	7.5	8.0	
●		●	●	●	09	.90	2.5	3.2	3.9	4.5	5.5	6.4	7.1	7.8	8.4	9.0	

Highlighted column shows the rated pressure.

DIMENSIONS AND WEIGHTS

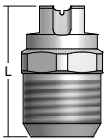
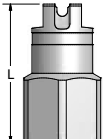
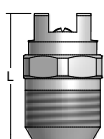
Nozzle	Nozzle Type	Inlet Conn. (in.)	L (in.)	Hex. (in.)	D (Dia.) (in.)	Flats (in.)	Net Weight (oz.)
	MEG (M)	1/8	1.000	9/16	-	0.313	0.6
		1/4	1.000	9/16	-	0.406	0.8
	WEG (F)	1/8	1.125	1/2	-	0.313	0.9
		1/4	1.125	5/8	-	0.313	0.7
	MEG-SSTC (M)	1/4	0.906	9/16	-	0.406	0.6

Based on the largest/heaviest version of each type.

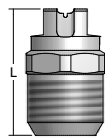
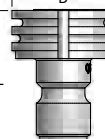
Nozzle	Nozzle Type	Inlet Conn. (in.)	L (in.)	Hex. (in.)	D (Dia.) (in.)	Flats (in.)	Net Weight (oz.)
	IMEG® (M)	1/8	0.875	1/2	-	0.313	0.6
		1/4	0.906	9/16	-	0.406	0.8
	QCIMEG/ QCIMEG	-	1.219	-	0.969	-	0.8

Based on the largest/heaviest version of each type.

OVERVIEW: UNIJET HIGH PRESSURE SPRAY NOZZLE

- Designed for operations requiring higher impact
- Save on nozzle replacement costs – bodies can be reused, only spray tips are replaced
- Design allows easy tip change out – remove tips by unscrewing the retainer cap
- Flat spray nozzles provide an even edge fan type spray pattern
- Spray angles from 0° to 65°
- Uniform spray distribution across the entire spray pattern and flow rates from .41 to 17.3 gpm (1.5 to 64 lpm)
- Operating pressures from 300 to 3000 psi (20 to 200 bar) – higher than standard tips
- Body assembly consists of high pressure nozzle body, strainer, tip gasket and high pressure tip retainer

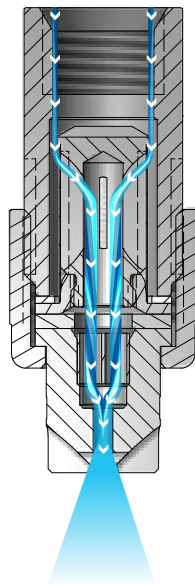

UniJet High Pressure Nozzles

As the liquid exits through the rounded U shape of the orifice, it forms into a flat spray pattern. The distribution is even at pressures above 300 psi (20 bar).

UNIJET HIGH PRESSURE SPRAY NOZZLE

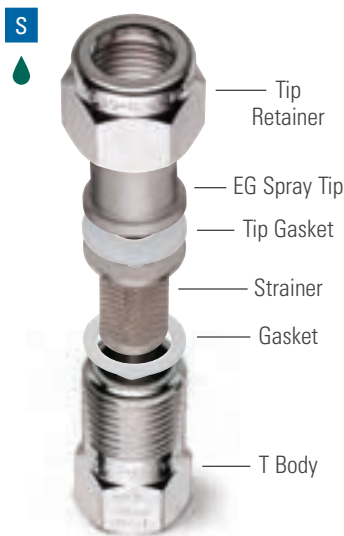

EG Spray Tip + 11430 Assembly

Use with gasket, screen strainer, tip gasket and high pressure tip retainer

ORDERING INFORMATION

UNIJET HIGH PRESSURE

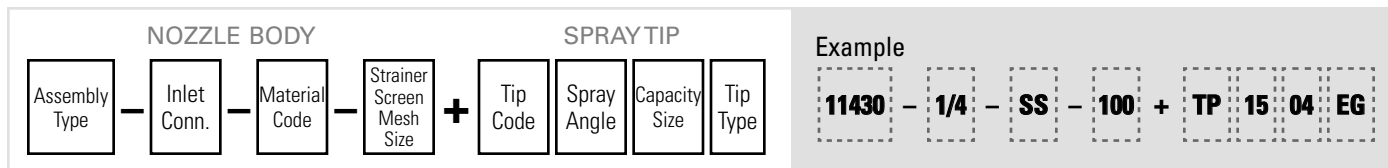

BSPT connections require the addition of a "B" prior to the nozzle body inlet connection.

RELATIVE DROP SIZE IN MICRONS

10 to 100	100 to 500	500 to 1000	1000 to 5000
-----------	------------	-------------	--------------

Drop size will vary based on flow rate and pressure.



QUICK REFERENCE GUIDE

Model	Connection	Connection Size (in.)	Materials	Page Number	
				Performance Data	Dimensions and Weights
11430 body assembly	F	1/4	303 stainless steel (SS)	–	C39
EG spray tip	NA	NA	Hardened stainless steel	C39	

F = female thread; NA = not applicable. No material code is required for hardened stainless steel. Leave material code blank when ordering.
For more dimensions and sizes, contact your sales engineer.

S PERFORMANCE DATA: STANDARD ANGLE SPRAY

UniJet Tip Type	Spray Angle at 40 psi						Capacity Size	Flow Rate Capacity (gallons per minute)								
	EG	0°*	15°	25°	40°	50°		65°	40 psi	300 psi	500 psi	750 psi	1000 psi	1500 psi	2000 psi	2500 psi
•	•						015	.15	.41	.53	.65	.75	.92	1.1	1.2	1.3
•	•						02	.20	.55	.71	.87	1.0	1.2	1.4	1.6	1.7
•	•	•	•				03	.30	.82	1.1	1.3	1.5	1.8	2.1	2.4	2.6
•	•	•	•	•		•	04	.40	1.1	1.4	1.7	2.0	2.4	2.8	3.2	3.5
•	•	•	•	•			045	.45	1.2	1.6	1.9	2.3	2.8	3.2	3.6	3.9
•	•	•	•	•			05	.50	1.4	1.8	2.2	2.5	3.1	3.5	4.0	4.3
•	•	•	•	•			055	.55	1.5	1.9	2.4	2.8	3.4	3.9	4.3	4.8
•	•	•	•	•	•	•	06	.60	1.6	2.1	2.6	3.0	3.7	4.2	4.7	5.2
•	•		•				065	.65	1.8	2.3	2.8	3.3	4.0	4.6	5.1	5.6
•	•	•	•	•	•	•	07	.70	1.9	2.5	3.0	3.5	4.3	4.9	5.5	6.1
•	•	•	•	•		•	08	.80	2.2	2.8	3.5	4.0	4.9	5.7	6.3	6.9
•	•	•	•	•		•	09	.90	2.5	3.2	3.9	4.5	5.5	6.4	7.1	7.8
•	•	•	•	•	•		10	1.0	2.7	3.5	4.3	5.0	6.1	7.1	7.9	8.7
•	•		•				11	1.1	3.0	3.9	4.8	5.5	6.7	7.8	8.7	9.5
•			•				12	1.2	3.3	4.2	5.2	6.0	7.3	8.5	9.5	10.4
•	•	•		•			13	1.3	3.6	4.6	5.6	6.5	8.0	9.2	10.3	11.3
•	•						14	1.4	3.8	4.9	6.1	7.0	8.6	9.9	11.1	12.1
•		•	•	•			15	1.5	4.1	5.3	6.5	7.5	9.2	10.6	11.9	13.0
•	•			•	•		20	2.0	5.5	7.1	8.7	10.0	12.2	14.1	15.8	17.3

*0° = Solid Stream.

Other body types may be available. Contact representative for further information.

Highlighted column shows the rated pressure.

DIMENSIONS AND WEIGHTS

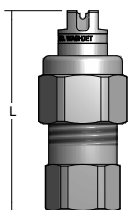
Nozzle	Nozzle Type	Inlet Conn. (in.)	L (in.)	Hex. (in.)	Net Weight (oz.)
	11430 (F) + EG	1/4	2.218	13/16	3.5

Based on the largest/heaviest version of each type.



FLAT
SPRAY

FLOODJET® NOZZLES

W WIDE ANGLE SPRAY

OVERVIEW: FLOODJET

- Ideal for operations requiring wide coverage
- Wide angle, deflected type flat fan spray pattern
- Use when nozzles can be mounted horizontally
- Orifice is protected from damage and is designed to minimize clogging
- Spray angles from 73° to 153°
- Uniform spray distribution from .04 to 110 gpm (.14 to 410 lpm)
- Operating pressures up to 60 psi (4 bar)
- TEK provides a tapered edge spray pattern to eliminate heavy edges while maintaining the wide spray pattern

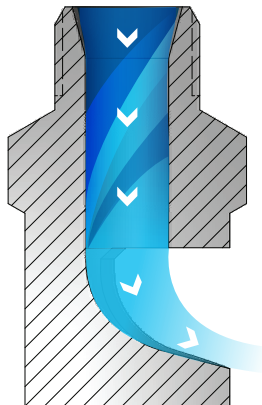

FloodJet Nozzles

As liquid passes through the nozzle, it hits the deflector surface and spreads out to form a flat spray pattern. The distribution is even from the center of the spray. The deflector surface enables the formation of very wide spray angles compared to other flat spray nozzles.

FLOODJET OPTIONS



K
1/8" to 1" male conn.



TEK
1/8" to 1/4" male conn.

ORDERING INFORMATION

FLOODJET K

Inlet Conn.	Nozzle Type	—	Material Code	Capacity Size	Example
					1/8 K — SS 2

BSPT connections require the addition of a "B" prior to the inlet connection.

FLOODJET TEK

Inlet Conn.	Nozzle Type	—	Material Code	Capacity Size	Example
					1/8 TEK — SS 2

BSPT connections require the addition of a "B" prior to the inlet connection.

RELATIVE DROP SIZE
IN MICRONS

10 to 100	100 to 500	500 to 1000	1000 to 5000
-----------	------------	-------------	--------------

Drop size will vary based on flow rate and pressure.

OVERVIEW: QUICK FLOODJET

- Ideal for high-maintenance operations – bodies remain on pipe/header; quick quarter-turn removes/installs spray tips in seconds
- Automatic alignment feature saves time
- Miniature versions are ideal when smaller physical size and lower weight are required
- Wide angle, deflected type flat fan spray pattern
- Spray angles from 73° to 153°
- Uniform spray distribution with flow rates from .01 to 14.7 gpm (.037 to 55 lpm)
- Operating pressures up to 60 psi (4 bar)

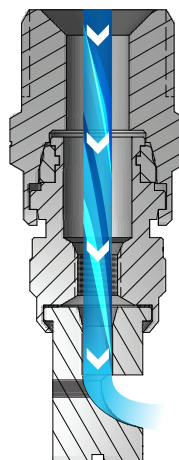

Quick FloodJet Nozzles

As liquid passes through the nozzle, it hits the deflector surface and spreads out to form a flat spray pattern. The distribution is even from the center of the spray. The deflector surface enables the formation of very wide spray angles compared to other flat spray nozzles.

QUICK FLOODJET OPTIONS



QTKA Spray Tip + QJA Body
1/8" to 1/2" female conn.
Use with QJA or QJJA body



QJJA Body
1/8" to 1/2" male conn.



QJJS Body
Miniature version
1/8" to 1/4" male conn.

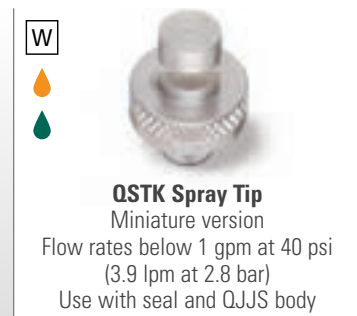

QSTK Spray Tip
Miniature version
Flow rates below 1 gpm at 40 psi
(3.9 lpm at 2.8 bar)
Use with seal and QJJS body

ORDERING INFORMATION

QUICK FLOODJET

NOZZLE BODY			SPRAY TIP			
Inlet Conn.	Body Type	Material Code	+	Tip Type	Material Code	Capacity Size

Example						
3/8	QJA	SS	+	QTKA	SS	1.5

BSPT connections require the addition of a "B" prior to the inlet connection.

**FLAT
SPRAY**

FLOODJET® NOZZLES

W WIDE ANGLE SPRAY

OVERVIEW: UNIJET® FLOODJET

- A large choice of interchangeable spray tips, body types/ sizes, materials, spray angles, flow rates and accessories allows use of different components in a single header to match performance to different operations
- Design allows easy tip change out in place – remove tips by unscrewing the retainer cap
- Wide angle, deflected type flat fan spray pattern
- Spray angles from 73° to 153°
- Uniform spray distribution with flow rates from .06 to 12.2 gpm (.28 to 46 lpm)
- Operating pressures up to 60 psi (4 bar)
- Assembly consists of nozzle body, strainer, spray tip and tip retainer

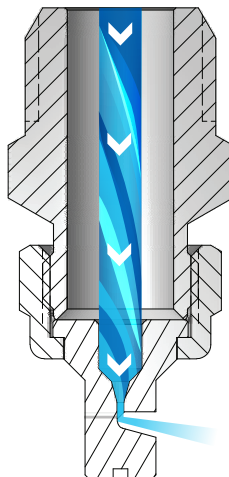

UniJet FloodJet Nozzles

As liquid passes through the nozzle, it hits the deflector surface and spreads out to form a flat spray pattern. The distribution is even from the center of the spray. The deflector surface enables the formation of very wide spray angles compared to other flat spray nozzles.

**UNIJET FLOODJET
OPTIONS**

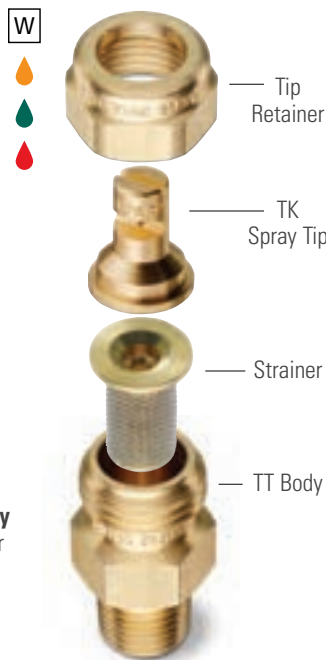

TK Spray Tip + TT Body
Use with screen strainer and tip retainer
1/8" to 1/2" male conn.



ORDERING INFORMATION

UNIJET FLOODJET

NOZZLE BODY			SPRAY TIP			
Inlet Conn.	Body Type	Material Code	+	Tip Type	Material Code	Capacity Size
Example						
1/4	TT	SS	+	TK	SS	2

UniJet nozzle assemblies include a pre-sized wire mesh based on orifice diameter. When ordering just a UniJet spray tip, the mesh is not included. See Accessories, page F6 for a mesh selection guide and ordering information.

BSPT connections require the addition of a "B" prior to the nozzle body inlet connection.

**RELATIVE DROP SIZE
IN MICRONS**

10 to 100	100 to 500	500 to 1000	1000 to 5000
-----------	------------	-------------	--------------

Drop size will vary based on flow rate and pressure.

QUICK REFERENCE GUIDE

Model	Connection	Connection Size (in.)	Materials	Page Number	
				Performance Data	Dimensions and Weights
K nozzle	M	1/8 to 1	Brass, 303 stainless steel (SS), 316 stainless steel (316SS), Polyvinyl chloride (PVC) Brass, 303 stainless steel (SS)	C43–C44	C46
TEK nozzle	M	1/8 to 1/4		C44	
QJA body	F	1/8 to 1/2		–	
QJJA body	M	1/8 to 1/2		–	
QTKA spray tip	NA	NA		C45	
QJJS body	M	1/8 or 1/4		–	
QSTK spray tip	NA	NA		C45	
T body	F	1/8 to 1/2		–	
TT body	M	1/8 to 1/2		–	
TK spray tip	NA	NA		C45–C46	

F = female thread; M = male thread; NA = not applicable. There is no material code for brass. Leave material code blank when ordering. Other materials available upon request. For more dimensions and sizes, contact your sales engineer.

W PERFORMANCE DATA:
WIDE ANGLE SPRAY



Nozzle Type	Inlet Conn. (in.)						Capacity Size	Equiv. Orifice Dia. (in.)	Flow Rate Capacity (gallons per minute)							Spray Angle (°)		
	1/8	1/4	3/8	1/2	3/4	1			3 psi	7 psi	10 psi	20 psi	30 psi	40 psi	60 psi	7 psi	20 psi	60 psi
•	•						.25	.017	–	–	–	.04	.04	.05	.06	–	83	117
•	•						.50	.023	–	–	–	.07	.09	.10	.12	–	89	122
•	•						.75	.029	–	–	.075	.11	.13	.15	.18	–	106	125
•	•						1	.033	–	–	.10	.14	.17	.20	.24	–	103	128
•	•						1.5	.040	–	.13	.15	.21	.26	.30	.37	73	103	125
•	•	•					2	.047	–	.17	.20	.28	.35	.40	.49	83	113	129
•	•	•					2.5	.052	–	.21	.25	.35	.43	.50	.61	98	122	133
•	•	•					3	.057	–	.25	.30	.42	.52	.60	.73	86	112	126
•	•	•					4	.066	–	.33	.40	.57	.69	.80	.98	97	123	132
•	•	•					5	.074	.27	.42	.50	.71	.87	1.0	1.2	114	128	142
•	•	•					7.5	.091	.41	.63	.75	1.1	1.3	1.5	1.8	101	119	134
•	•	•					10	.105	.55	.84	1.0	1.4	1.7	2.0	2.4	115	133	145
•	•	•					12	.115	.66	1.0	1.2	1.7	2.1	2.4	2.9	128	139	153
•	•	•					15	.128	.82	1.3	1.5	2.1	2.6	3.0	3.7	98	113	123
•	•	•					18	.140	.99	1.5	1.8	2.5	3.1	3.6	4.4	106	120	131
•	•	•					20	.148	1.1	1.7	2.0	2.8	3.5	4.0	4.9	110	122	133

Highlighted column shows the rated pressure.



**FLAT
SPRAY**

FLOODJET® NOZZLES

W WIDE ANGLE SPRAY

**W PERFORMANCE DATA:
WIDE ANGLE SPRAY**

Nozzle Type	Inlet Conn. (in.)						Capacity Size	Equiv. Orifice Dia. (in.)	Flow Rate Capacity (gallons per minute)						Spray Angle (°)			
	K	1/8	1/4	3/8	1/2	3/4			1	3 psi	7 psi	10 psi	20 psi	30 psi	40 psi	60 psi	7 psi	20 psi
●		●					22	.155	1.2	1.8	2.2	3.1	3.8	4.4	5.4	113	125	136
●		●					24	.162	1.3	2.0	2.4	3.4	4.2	4.8	5.9	115	131	144
●		●					27	.172	1.5	2.3	2.7	3.8	4.7	5.4	6.6	119	135	148
●			●				30	.181	1.6	2.5	3.0	4.2	5.2	6.0	7.3	100	110	121
●			●				35	.196	1.9	2.9	3.5	4.9	6.1	7.0	8.6	105	118	128
●			●	●			40	.209	2.2	3.3	4.0	5.7	6.9	8.0	9.8	111	126	136
●			●				45	.222	2.5	3.8	4.5	6.4	7.8	9.0	11.0	115	130	140
●				●			50	.234	2.7	4.2	5.0	7.1	8.7	10.0	12.2	117	131	140
●				●			60	.256	3.3	5.0	6.0	8.5	10.4	12.0	14.7	120	134	142
●				●			70	.277	3.8	5.9	7.0	9.9	12.1	14.0	17.1	123	137	146
●				●			80	.296	4.4	6.7	8.0	11.3	13.9	16.0	19.6	127	138	149
●					●		90	.317	4.9	7.5	9.0	12.7	15.6	18.0	22	120	133	140
●					●		100	.334	5.5	8.4	10.0	14.1	17.3	20	24	123	136	145
●					●		110	.350	6.0	9.2	11.0	15.6	19.1	22	27	125	138	148
●					●		120	.366	6.6	10.0	12.0	17.0	21	24	29	129	143	150
●					●		140	.395	7.7	11.7	14.0	19.8	24	28	34	118	127	135
●					●		160	.423	8.8	13.4	16.0	23	28	32	39	121	130	137
●					●		180	.448	9.9	15.1	18.0	25	31	36	44	124	133	139
●					●		210	.484	11.5	17.6	21	30	36	42	51	128	139	145
●						●	300	.579	16.4	25	30	42	52	60	73	110	128	135
●						●	450	.709	25	38	45	64	78	90	110	118	132	138

Highlighted column shows the rated pressure.

**W PERFORMANCE DATA:
WIDE ANGLE SPRAY**

Inlet Conn. (in.)	Nozzle Type	Capacity Size	Equiv. Orifice Dia. (in.)	Flow Rate Capacity (gallons per minute)						Spray Angle (°)			
				3 psi	7 psi	10 psi	20 psi	30 psi	40 psi	60 psi	7 psi	20 psi	60 psi
1/8, 1/4	●	2	.047	–	.17	.20	.28	.35	.40	.49	85	125	134
	●	3	.057	–	.25	.30	.42	.52	.60	.73	85	125	136
	●	5	.074	.27	.42	.50	.71	.87	1.0	1.2	85	127	147
	●	10	.105	.55	.84	1.0	1.4	1.7	2.0	2.4	85	130	150
1/4	●	15	.128	.82	1.3	1.5	2.1	2.6	3.0	3.7	90	130	138
	●	20	.148	1.1	1.7	2.0	2.8	3.5	4.0	4.9	107	130	138

Highlighted column shows the rated pressure.



W PERFORMANCE DATA: WIDE ANGLE SPRAY

Inlet Conn. (in.)	Quick FloodJet Tip Type		Capacity Size	Equiv. Orifice Dia. (in.)	Flow Rate Capacity (gallons per minute)							Spray Angle (°)		
	QSTK	QTKA			3 psi	7 psi	10 psi	20 psi	30 psi	40 psi	60 psi	7 psi	20 psi	60 psi
1/8, 1/4, 3/8, 1/2	●		.25	.017	–	–	–	.04	.04	.05	.06	–	83	117
	●	●	.50	.023	–	–	–	.07	.09	.10	.12	–	89	122
	●	●	.75	.029	–	–	.075	.11	.13	.15	.18	–	106	125
	●	●	1	.033	–	–	.10	.14	.17	.20	.24	–	109	128
	●	●	1.5	.040	–	.13	.15	.21	.26	.30	.37	73	108	125
	●	●	2	.047	–	.17	.20	.28	.35	.40	.49	83	113	129
	●	●	2.5	.052	–	.21	.25	.35	.43	.50	.61	98	122	133
	●	●	3	.057	–	.25	.30	.42	.52	.60	.73	86	112	126
	●	●	4	.066	–	.33	.40	.57	.69	.80	.98	97	123	132
	●	●	5	.074	.27	.42	.50	.71	.87	1.0	1.2	114	128	142
		●	7.5	.091	.41	.63	.75	1.1	1.3	1.5	1.8	101	119	134
		●	10	.105	.55	.84	1.0	1.4	1.7	2.0	2.4	115	133	145
		●	12	.115	.66	1.0	1.2	1.7	2.1	2.4	2.9	128	139	153
		●	15	.128	.82	1.3	1.5	2.1	2.6	3.0	3.7	98	113	123
		●	18	.140	.99	1.5	1.8	2.5	3.1	3.6	4.4	106	120	131
	●	20	.148	1.1	1.7	2.0	2.8	3.5	4.0	4.9	110	122	133	
3/8, 1/2		●	30	.181	1.6	2.5	3.0	4.2	5.2	6.0	7.3	100	110	121
		●	40	.209	2.2	3.3	4.0	5.7	6.9	8.0	9.8	111	126	136
		●	45	.222	2.5	3.8	4.5	6.4	7.8	9.0	11.0	115	130	140
		●	60	.256	3.3	5.0	6.0	8.5	10.4	12.0	14.7	120	134	142

Highlighted column shows the rated pressure.

W PERFORMANCE DATA: WIDE ANGLE SPRAY

Inlet Conn. (in.)	UniJet® FloodJet Tip Type	Capacity Size	Equiv. Orifice Dia. (in.)	Flow Rate Capacity (gallons per minute)							Spray Angle (°)		
	TK			3 psi	7 psi	10 psi	20 psi	30 psi	40 psi	60 psi	7 psi	20 psi	60 psi
1/4	●	.50	.023	–	–	–	.07	.09	.10	.12	–	89	122
	●	.75	.029	–	–	.075	.11	.13	.15	.18	–	106	125
	●	1	.033	–	–	.10	.14	.17	.20	.24	–	109	128
	●	1.5	.040	–	.13	.15	.21	.26	.30	.37	73	108	125
	●	2	.047	–	.17	.20	.28	.35	.40	.49	83	113	129
	●	2.5	.052	–	.21	.25	.35	.43	.50	.61	98	122	133
	●	3	.057	–	.25	.30	.42	.52	.60	.73	86	112	126
	●	4	.066	–	.33	.40	.57	.69	.80	.98	97	123	132
	●	5	.074	.27	.42	.50	.71	.87	1.0	1.2	114	128	142

Other body types may be available. Contact your sales engineer for further information.

Highlighted column shows the rated pressure.



**FLAT
SPRAY**

FLOODJET® NOZZLES

W WIDE ANGLE SPRAY

W PERFORMANCE DATA:
WIDE ANGLE SPRAY

Inlet Conn. (in.)	UniJet® FloodJet Tip Type	Capacity Size	Equiv. Orifice Dia. (in.)	Flow Rate Capacity (gallons per minute)							Spray Angle (°)		
	TK			3 psi	7 psi	10 psi	20 psi	30 psi	40 psi	60 psi	7 psi	20 psi	60 psi
1/4	●	7.5	.091	.41	.63	.75	1.1	1.3	1.5	1.8	101	119	134
	●	10	.105	.55	.84	1.0	1.4	1.7	2.0	2.4	115	133	145
	●	12	.115	.66	1.0	1.2	1.7	2.1	2.4	2.9	128	139	153
	●	15	.128	.82	1.3	1.5	2.1	2.6	3.0	3.7	98	113	123
	●	18	.140	.99	1.5	1.8	2.5	3.1	3.6	4.4	106	120	131
	●	20	.148	1.1	1.7	2.0	2.8	3.5	4.0	4.9	110	122	133
	●	24	.162	1.3	2.0	2.4	3.4	4.2	4.8	5.9	115	131	144
	●	30	.181	1.6	2.5	3.0	4.2	5.2	6.0	7.3	100	110	121
	●	40	.209	2.2	3.3	4.0	5.7	6.9	8.0	9.8	111	126	136
	●	50	.234	2.7	4.2	5.0	7.1	8.7	10.0	12.2	117	131	140

Other body types may be available. Contact your sales engineer for further information.

Highlighted column shows the rated pressure.

DIMENSIONS AND WEIGHTS

Nozzle	Nozzle Type	Inlet Conn. (in.)	L (in.)	Hex. (in.)	D (Dia.) (in.)	Net Weight (oz.)
	K (M)	1/8	1.219	9/16	–	1
		1/4	1.343	9/16	–	1
		3/8	1.750	11/16	–	2
		1/2	2.000	7/8	–	4
		3/4	2.563	1-1/2	–	7
		1	3.625	1-7/8	–	32
	TEK (M)	1/8	1.125	7/16	–	0.6
		1/4	1.520	9/16	–	1.5
	QJA (F) + QTKA	1/8, 1/4, 3/8, 1/2	2.531	1	–	5
	QJJA (M) + QTKA	1/8, 1/4, 3/8, 1/2	2.438	7/8	–	4.5

Based on the largest/heaviest version of each type.

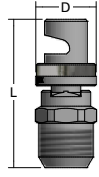
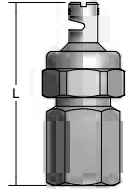
Nozzle	Nozzle Type	Inlet Conn. (in.)	L (in.)	Hex. (in.)	D (Dia.) (in.)	Net Weight (oz.)
	QJJS (M) + QSTK	1/8, 1/4, 3/8, 1/2	1.469	9/16	0.594	1.5
	T (F) + TK	1/4	2.000	13/16	–	2.5
	TT (M) + TK	1/4	2.000	13/16	–	2.3

Based on the largest/heaviest version of each type.



OVERVIEW: FLATJET

- Provides higher impact than other narrow angle nozzles
- Deflected type flat fan spray pattern
- Ideal for conveyor cleaning
- Spray angles from 15° to 50°
- Uniform spray distribution from .24 to 39 gpm (.91 to 144 lpm)
- Operating pressures up to 150 psi (10 bar)

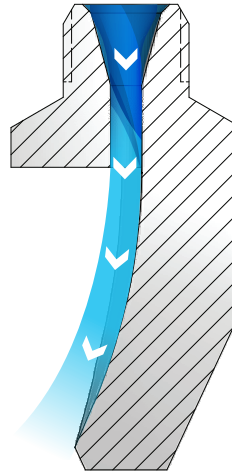

FlatJet Nozzles

As liquid passes through the nozzle, it hits the deflector surface and spreads out to form a flat spray pattern. The distribution is even from the center of the spray. The combination of medium- to large-flow rates and narrow spray angles produce a high impact spray.

FLATJET OPTIONS

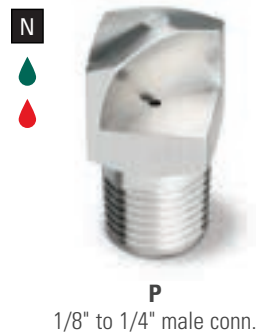

ORDERING INFORMATION

FLATJET P

Inlet Conn.	Nozzle Type	—	Material Code	Spray Angle	Capacity Size	Example
						3/8 P — SS 50 60

BSPT connections require the addition of a "B" prior to the inlet connection.

RELATIVE DROP SIZE IN MICRONS



Drop size will vary based on flow rate and pressure.

**FLAT
SPRAY**

FLATJET® NOZZLES

N NARROW ANGLE SPRAY

QUICK REFERENCE GUIDE

Model	Connection	Connection Size (in.)	Materials	Page Number	
				Performance Data	Dimensions and Weights
P	M	1/8 to 3/4	Brass, Mild steel (I), 303 stainless steel (SS), 316 stainless steel (316SS)	C48-C49	C48-C49

M = male thread. There is no material code for brass. Leave material code blank when ordering. Other materials available upon request.

For more dimensions and sizes, contact your sales engineer.

N PERFORMANCE DATA:
NARROW ANGLE SPRAY





Spray Angle (°) at 40 psi	Nozzle Type	Inlet Conn. (in.)					Capacity Size	Equiv. Orifice Dia. (in.)	Flow Rate Capacity (gallons per minute)							Spray Angle (°)			Dimensions			
		P	1/8	1/4	3/8	1/2			3/4	15 psi	20 psi	40 psi	80 psi	100 psi	150 psi	15 psi	40 psi	100 psi	A Length (in.)	B Deflection Angle (°)	C Bar Size (in. sq.)	Net Weight (oz.)
50	●		●				05	.052	.31	.35	.50	.71	.79	.97	33	50	60	1-7/32	60	5/8	1	
	●		●				10	.074	.61	.71	1.0	1.4	1.6	1.9	34	50	60	1-7/32	60	5/8	1	
	●		●	●			25	.117	1.5	1.8	2.5	3.5	4.0	4.8	42	50	59	1-5/8	42	3/4	3	
	●		●	●			40	.148	2.4	2.8	4.0	5.7	6.3	7.7	39	50	60	1-27/32	45	3/4	3	
	●			●			60	.181	3.7	4.2	6.0	8.5	9.5	11.6	42	50	53	2-5/32	37	1	5	
	●			●			100	.234	6.1	7.1	10.0	14.1	15.8	19.4	43	50	55	2-27/32	40	1-1/4	11.5	
	●			●			125	.261	7.7	8.8	12.5	17.7	19.8	24	38	50	59	2-27/32	38	1-1/4	11	
	●			●			160	.296	9.8	11.3	16.0	23	25	31	44	50	55	2-27/32	37	1-1/4	11	
	●			●			200	.331	12.2	14.1	20	28	32	39	46	50	53	2-27/32	32	1-1/4	11	
40	●			●			40	.148	2.4	2.8	4.0	5.7	6.3	7.7	31	40	50	2-3/8	35	7/8	5	
	●			●			50	.165	3.1	3.5	5.0	7.1	7.9	9.7	31	40	49	2-1/2	33	1	7	
	●			●			60	.181	3.7	4.2	6.0	8.5	9.5	11.6	32	40	49	2-27/32	33	1	8	
	●			●			70	.196	4.3	4.9	7.0	9.9	11.1	13.6	32	40	49	2-31/32	29	1	9	
	●			●			80	.209	4.9	5.7	8.0	11.3	12.6	15.5	32	40	48	3-1/32	26	1	9	
	●			●			90	.222	5.5	6.4	9.0	12.7	14.2	17.4	34	40	44	3-1/32	28	1	8	
	●			●			100	.234	6.1	7.1	10.0	14.1	15.8	19.4	35	40	44	3-13/32	28	1	9	

Highlighted column shows the rated pressure.



N PERFORMANCE DATA:
NARROW ANGLE SPRAY

Spray Angle (°) at 40 psi	Nozzle Type	Inlet Conn. (in.)					Capacity Size	Equiv. Orifice Dia. (in.)	Flow Rate Capacity (gallons per minute)						Spray Angle (°)			Dimensions			
		P	1/8	1/4	3/8	1/2			3/4	15 psi	20 psi	40 psi	80 psi	100 psi	150 psi	15 psi	40 psi	100 psi	A Length (in.)	B Deflection Angle (°)	C Bar Size (in. sq.)
35	•	•					04	.047	.24	.28	.40	.57	.63	.77	20	35	41	29/32	40	7/16	.5
	•		•				10	.074	.61	.71	1.0	1.4	1.6	1.9	18	35	39	1-7/16	36	5/8	2
	•		•	•			20	.105	1.2	1.4	2.0	2.8	3.2	3.9	24	35	40	1-21/32	30	3/4	2
	•			•			25	.117	1.5	1.8	2.5	3.5	4.0	4.8	24	35	39	1-15/16	28	3/4	3
	•			•			30	.128	1.8	2.1	3.0	4.2	4.7	5.8	26	35	41	2-1/16	28	3/4	3
	•			•			40	.148	2.4	2.8	4.0	5.7	6.3	7.7	28	35	38	2-9/32	26	7/8	4
	•			•			50	.165	3.1	3.5	5.0	7.1	7.9	9.7	31	35	38	2-1/2	23	7/8	5
	•				•		60	.181	3.7	4.2	6.0	8.5	9.5	11.6	29	35	39	2-7/8	27	1	8
	•				•		80	.209	4.9	5.7	8.0	11.3	12.6	15.5	26	35	40	3-3/16	24	1	9
	•				•		100	.234	6.1	7.1	10.0	14.1	15.8	19.4	26	35	40	3-1/2	19	1	9
	•					•	160	.296	9.8	11.3	16.0	23	25	31	26	35	40	4-1/2	23	1-1/4	20
	•					•	200	.331	12.2	14.1	20	28	32	39	25	35	40	4-13/16	22	1-1/4	20
25	•		•				40	.148	2.4	2.8	4.0	5.7	6.3	7.7	15	25	34	2-9/16	25	3/4	4
15	•		•				10	.074	–	.71	1.0	1.4	1.6	1.9	–	15	23	1-7/8	22	5/8	2
	•		•				20	.105	–	1.4	2.0	2.8	3.2	3.9	–	15	19	2-1/8	19	5/8	2
	•			•			30	.128	1.8	2.1	3.0	4.2	4.7	5.8	6	15	24	2-27/32	25	3/4	4
	•			•			40	.148	2.4	2.8	4.0	5.7	6.3	7.7	8	15	21	3-5/8	18	7/8	8
	•			•			50	.165	3.1	3.5	5.0	7.1	7.9	9.7	9	15	20	3-9/16	15	7/8	6
	•				•		60	.181	3.7	4.2	6.0	8.5	9.5	11.6	10	15	19	4-15/16	14	1	12
	•				•		80	.209	4.9	5.7	8.0	11.3	12.6	15.5	11	15	18	5-1/8	14	1	12
	•				•		100	.234	6.1	7.1	10.0	14.1	15.8	19.4	11	15	18	5-5/32	14	1	14
	•					•	200	.331	12.2	14.1	20	28	32	39	12	15	18	6-1/2	14	1-1/4	26

Highlighted column shows the rated pressure.



**FLAT
SPRAY**

ULTRA-HIGH PRESSURE NOZZLES

S STANDARD ANGLE SPRAY

OVERVIEW: ULTRA-HIGH PRESSURE FS AND VS

- Ultra-high pressure, high impact flat spray or solid stream
- Operating pressures are up to 10 times higher than other high pressure nozzles – up to 60,000 psi (4000 bar)
- Traditional and quick-connect options;
 - Save on nozzle replacement costs – nozzle bodies can be reused – only spray tips are replaced
- Long wear life – nozzles are hardened stainless steel. Spray tips are available with extra hard sapphire inserts for maximum wear resistance
- Spray angles from 0° to 45°
- Uniform spray distribution from 0.03 to 78 gpm (0.11 to 295 lpm)
- Nozzle bodies include O-ring, gasket (58833 only) and tip retainer

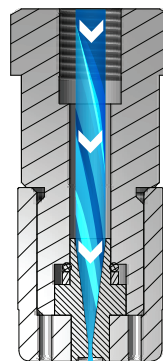

Ultra-High Pressure Nozzles

As liquid passes through the engineered orifice, a very high impact spray pattern is produced in either zero degree (solid stream) or flat spray pattern.

FS AND VS OPTIONS



VS010 Spray Tip + 58834 Body
Operating pressure up to 20,000 psi (1400 bar)



VS625
1/4" male conn.
Operating pressure up to 17,500 psi (1200 bar)

S

VS940
1/16" male conn.
Operating pressure up to 15,000 psi (1000 bar)

58833 Body
3/8" to 1/2" male or female conn.

S

VS020 Spray Tip
Use with 58834 nozzle body
Operating pressure up to 30,000 psi (2000 bar)

S

VS051 Spray Tip
No threads*
Operating pressure up to 60,000 psi (4000 bar)

*Customer supplies holder

S

FS013 Spray Tip
Use with 58834 nozzle body
Operating pressure up to 30,000 psi (2000 bar)

S

FS020 Spray Tip
Use with 58833 nozzle body
Operating pressure up to 30,000 psi (2000 bar)

RELATIVE DROP SIZE IN MICRONS

10 to 100	100 to 500	500 to 1000	1000 to 5000
-----------	------------	-------------	--------------

Drop size will vary based on flow rate and pressure.

ORDERING INFORMATION

ULTRA-HIGH PRESSURE VS625 AND VS940



ULTRA-HIGH PRESSURE D58834 BODY WITH FS013, VS010 OR VS020 SPRAY TIP*

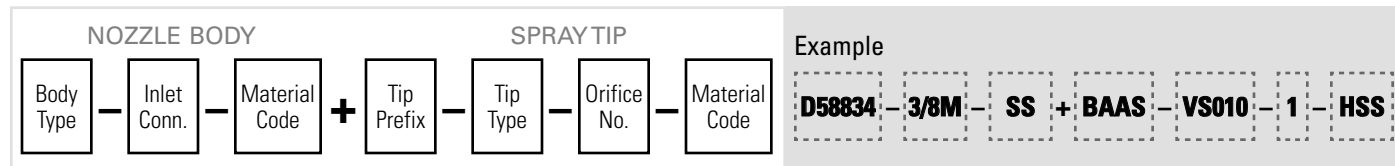

*Note: VS051 is available as a spray tip only.

ULTRA-HIGH PRESSURE D58833 BODY WITH FS020 SPRAY TIP

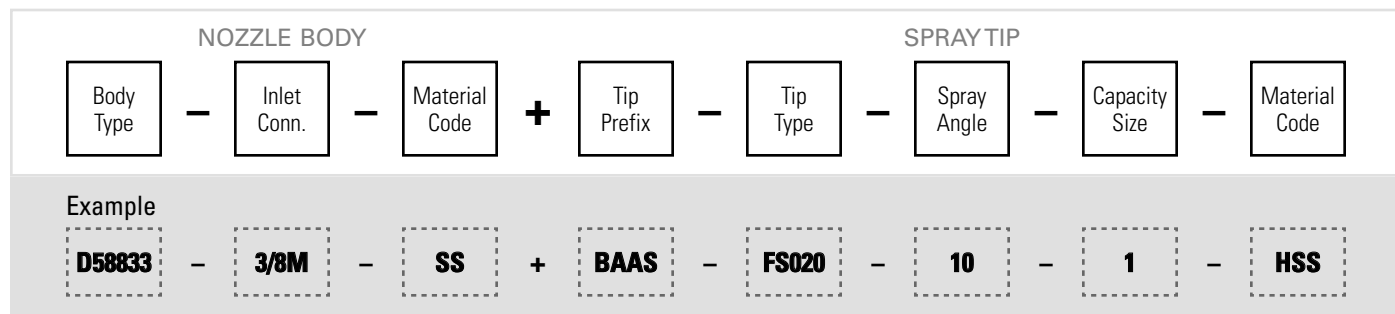

QUICK REFERENCE GUIDE

Model	Connection	Connection Size (in.)	Materials	Page Number	
				Performance Data	Dimensions and Weights
VS625 nozzle	M	1/4	Stainless steel with sapphire insert (SSAP)	C52	C54
VS940 nozzle	M	1/16		C52	
VS010 spray tip	NA	NA	Hardened stainless steel (HSS)	C52	
VS020 spray tip	NA	NA	Stainless steel with sapphire insert (SSAP)	C53	
VS051 spray tip	NA	NA		C53	
FS013 spray tip	NA	NA	Hardened stainless steel (HSS)	C53	
FS020 spray tip	NA	NA		C53	
58833 body	M, F	3/8 to 1/2	Stainless steel (SS)	-	
58834 body	M, F	3/8 to 1/2		-	

F = female thread; M = male thread; NA = not applicable.
For more dimensions and sizes, contact your sales engineer.

**FLAT
SPRAY**

ULTRA-HIGH PRESSURE NOZZLES

S STANDARD ANGLE SPRAY

S PERFORMANCE DATA:
STANDARD ANGLE SPRAY

Nozzle Type	Inlet Conn. (in.)	Spray Angle	Orifice No.	Equiv. Orifice Dia. (in.)	Flow Rate Capacity (gallons per minute)			
					1500 psi	7500 psi	10000 psi	17500 psi
VS625	1/4	0°	0.25	0.010	0.09	0.20	0.23	0.31
•			0.5	0.020	0.36	0.79	0.93	1.2
•			0.75	0.030	0.81	1.8	2.1	2.7
•			1	0.039	1.4	3.2	3.7	4.9
•			1.5	0.059	3.2	7.1	8.4	11.0
•			2	0.079	5.8	12.7	15.0	19.6
•			2.5	0.098	9.0	19.7	23	31

S PERFORMANCE DATA:
STANDARD ANGLE SPRAY

Nozzle Type	Inlet Conn. (in.)	Spray Angle	Orifice No.	Equiv. Orifice Dia. (in.)	Flow Rate Capacity (gallons per minute)		
					7500 psi	10000 psi	15000 psi
VS940	1/16	0°	0.5	0.020	0.8	0.9	1.1
•			0.75	0.030	1.8	2.1	2.6
•			1	0.039	3.2	3.7	4.5
•			1.5	0.059	7.3	8.3	10.2
•			2	0.079	12.9	14.8	18.2
•			2.5	0.098	20	23	28

S PERFORMANCE DATA:
STANDARD ANGLE SPRAY

Tip Type	Spray Angle	Orifice No.	Equiv. Orifice Dia. (in.)	Flow Rate Capacity (gallons per minute)						
				1500 psi	3500 psi	7500 psi	10000 psi	15000 psi	17500 psi	20000 psi
VS010	0°	1	0.039	1.7	2.6	3.9	4.4	5.4	5.8	6.2
•		1.5	0.059	4.0	5.9	8.9	10.2	12.4	13.4	14.3
•		2	0.079	6.8	10.1	15.2	17.5	21	23	25
•		2.5	0.098	11.0	16.3	25	28	34	37	40
•		3	0.118	16.6	25	37	43	52	56	60
•		3.5	0.138	21	33	48	52	68	73	78



S PERFORMANCE DATA:
STANDARD ANGLE SPRAY

Tip Type	Spray Angle	Orifice No.	Equiv. Orifice Dia. (in.)	Flow Rate Capacity (gallons per minute)				
				7500 psi	10000 psi	15000 psi	20000 psi	30000 psi
VS020	0°	0.5	0.020	0.8	0.9	1.1	1.3	1.6
•		0.75	0.030	1.8	2.1	2.6	3.0	3.6
•		1	0.039	3.2	3.7	4.5	5.3	6.4
•		1.5	0.059	7.3	8.3	10.2	11.9	14.4
•		2	0.079	12.9	14.8	18.2	21	26
•		2.5	0.098	20	23	28	33	40

S PERFORMANCE DATA:
STANDARD ANGLE SPRAY

Tip Type	Spray Angle	Orifice No.	Equiv. Orifice Dia. (in.)	Flow Rate Capacity (gallons per minute)			
				15000 psi	30000 psi	40000 psi	60000 psi
VS051	0°	0.1	0.004	0.03	0.05	0.06	0.07
•		0.25	0.010	0.21	0.30	0.34	0.42
•		0.5	0.020	0.84	1.2	1.4	1.7
•		0.75	0.030	1.9	2.7	3.1	3.8
•		1	0.039	3.4	4.7	5.5	6.7

S PERFORMANCE DATA:
STANDARD ANGLE SPRAY

Tip Type	Spray Angle at 300 psi			Capacity Size	Equiv. Orifice Dia. (in.)	Flow Rate Capacity (gallons per minute)				
	10°	20°	45°			1500 psi	7500 psi	10000 psi	15000 psi	30000 psi
FS013	•	•	–	0.54	0.013	0.15	0.33	0.38	0.46	0.65
•	•	•	–	1	0.018	0.27	0.61	0.70	0.85	1.2
•	•	•	–	1.5	0.022	0.41	0.91	1.0	1.3	1.8
•	•	•	•	2	0.026	0.54	1.2	1.4	1.7	2.4
•	•	•	•	3	0.031	0.81	1.8	2.1	2.6	3.6

S PERFORMANCE DATA:
STANDARD ANGLE SPRAY

Tip Type	Spray Angle at 300 psi			Capacity Size	Equiv. Orifice Dia. (in.)	Flow Rate Capacity (gallons per minute)				
	10°	20°	45°			1500 psi	7500 psi	10000 psi	15000 psi	30000 psi
FS020	•	•	•	4.5	0.039	1.2	2.7	3.1	3.8	5.4
•	•	•	•	11	0.059	2.9	6.6	7.7	9.3	13.2
•	•	•	•	19	0.079	5.1	11.4	13.2	16.1	23
•	•	•	•	28	0.098	7.5	16.8	19.5	24	34
•	•	•	•	40	0.118	10.7	24	28	34	48

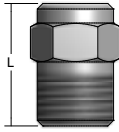
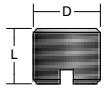
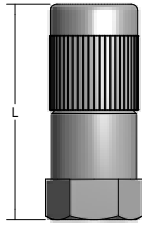
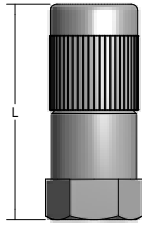

DIMENSIONS AND WEIGHTS

Nozzle	Nozzle Type	Inlet Conn. (in.)	L (in.)	Hex. (in.)	D (Dia.) (in.)	Net Weight (oz.)
	VS625	1/4 (M)	0.87	9/16	–	0.7
	VS940	1/16 (M)	0.26	–	0.31	0.06
	58834 (M) + FS013	3/8	2.75	1-1/16	–	9.7
	58834 (F) + FS013	3/8	2.75	1-1/16	–	9.7
	58834 (M) + FS013	1/2	2.75	1-1/16	–	9.7
	58834 (F) + FS013	1/2	2.75	1-1/16	–	9.7
	58833 (M) + FS020	3/8	2.75	1-1/16	–	9.8
	58833 (F) + FS020	3/8	2.75	1-1/16	–	9.8
	58833 (M) + FS020	1/2	2.75	1-1/16	–	9.8
	58833 (F) + FS020	1/2	2.75	1-1/16	–	9.8

Based on the largest/heaviest version of each type.

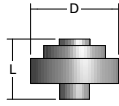
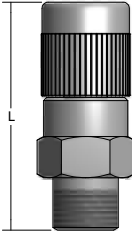
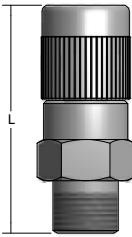
Nozzle	Nozzle Type	Inlet Conn. (in.)	L (in.)	Hex. (in.)	D (Dia.) (in.)	Net Weight (oz.)
	VS051 spray tip	–	0.23	–	0.37	0.06
	58834 (M) + VS010	3/8	2.87	1-1/16	–	9.7
	58834 (F) + VS010	3/8	2.87	1-1/16	–	9.7
	58834 (M) + VS010	1/2	2.87	1-1/16	–	9.7
	58834 (F) + VS010	1/2	2.87	1-1/16	–	9.7
	58834 (M) + VS020	3/8	2.87	1-1/16	–	9.7
	58834 (F) + VS020	3/8	2.87	1-1/16	–	9.7
	58834 (M) + VS020	1/2	2.87	1-1/16	–	9.7
	58834 (F) + VS020	1/2	2.87	1-1/16	–	9.7

Based on the largest/heaviest version of each type.



HOLLOW CONE NOZZLES

GAS COOLING · SULFUR BURNING
DUST CONTROL · WATER AERATING
CHEMICAL PRODUCTION · COOLING
METAL TREATING · WASHING
GAS SCRUBBING · BRINE SPRAYING
PRODUCT DEGREASING



HOLLOW CONE NOZZLES
INTRODUCTION



WIDE RANGE OF CAPACITIES, CONNECTIONS AND MATERIALS TO MATCH YOUR APPLICATION

Styles:

- Conventional
- Quick-connect

Spray patterns:

- Standard
- Extra wide angle
- Wide angle

Spray angles: 43° to 180°

Flow rate range: .05 to 3320 gpm (.19 to 12568 lpm)

Operating pressure range: up to 2000 psi (138 bar)

Connections:

- 1/8" to 6" pipe sizes
- Flange
- Female and male NPT and BSPT

Materials:

- Brass
- Mild steel
- 303 stainless steel
- 309 stainless steel
- 316 stainless steel
- Hardened stainless steel
- Polypropylene
- Polyvinyl chloride
- PTFE
- Other specialty materials available

See Trademark Registration and Ownership, page i-1.

OPTIMIZE THE PERFORMANCE OF HOLLOW CONE NOZZLES:

Prevent clogging problems by using a **T-style strainer**. Our 124 strainers are available in several styles for use in high flow rate applications. Options include self-cleaning versions, large screen sizes to reduce cleaning frequency and more. **See page F4**



For quick and easy in-line manual shut-off, use our **23220 ball valve**. Two activation options – handle or hex Allen wrench. Available with a wide range of connection options. **See page F29**













Accurately monitor liquid pressure with durable, accurate **pressure gauges**. Grade B accuracy, corrosion resistance, impact resistance and psi/bar dual scales are just a few of the features these gauges offer. **See page F38**





**HOLLOW CONE NOZZLES
TABLE OF CONTENTS**



WHIRLJET® NOZZLES:
STANDARD, WIDE AND EXTRA WIDE ANGLE SPRAYS

	PAGE
 AX nozzles	D4
 BX nozzles	D4
 CX nozzles	D4
 CF nozzles	D4
 CRC nozzles	D4
 D nozzles	D4
 AP nozzles	D5
 LAP and LBP nozzles	D5
 E nozzles	D5
 Quick Reference Guide	D6





SPIRALJET® NOZZLES:
STANDARD ANGLE SPRAY

	PAGE
 BSJ nozzles	D18
 Quick Reference Guide	D18

UNIJET® NOZZLES:
STANDARD AND WIDE ANGLE SPRAYS

	PAGE
 T, TT and 11430 UniJet bodies	D20
 TX, D, T-W, TN and TN-SSTC UniJet spray tips	D20
 Quick Reference Guide	D21

WHIRLJET® NOZZLES:
IN-LINE STANDARD, IN-LINE WIDE ANGLE, OFFSET-TYPE
STANDARD AND DEFLECTED SPRAYS

	PAGE
 BD nozzles	D27
 BDM nozzles	D27
 BA nozzles	D27
 DeflectoJet® 8686 nozzles	D27
 Quick Reference Guide	D28



OVERVIEW: WHIRLJET STANDARD, WIDE AND EXTRA WIDE ANGLE NOZZLES

- Hollow cone spray pattern with a circular impact area
- Large, unobstructed flow passages minimize clogging
- Good atomization of liquids at lower pressures – ideal for fluid cooling applications
- Removable caps for easy inspection and cleaning on some models
- Slope-bottom design models reduce the drilling effect of the fluid vortex in the fluid chamber and premature wear
- AX and BX nozzles form smaller drops; ideal for use in air washers and dust suppression applications
- CX, CF, CRC and D nozzles feature higher flow rates; ideal for use in larger, evaporative cooling spray ponds
- AP, LAP and LBP nozzles are constructed of polypropylene and feature excellent corrosion resistance at temperatures up to 160°F (71°C); patented center post design provides extended wear life of the nozzle
- Standard, wide and extra wide spray angles

WhirlJet Nozzles

As liquid enters the nozzle, it passes into a whirlchamber and begins to spin in a circle at high speed. The rotation forces the liquid away from the center toward the edges of the whirlchamber. This causes the liquid to exit the orifice in a hollow cone pattern. Some WhirlJet nozzles have a slope bottom in the whirlchamber that helps extend wear life.

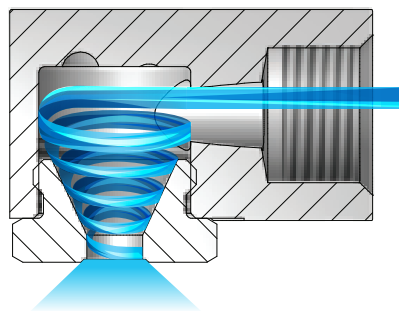

WHIRLJET AX, BX, CX AND D NOZZLES

- Spray angles: Standard – 43° to 91°, Wide – 112° to 120°
- Uniform spray distribution:
 - AX and BX nozzles – from .03 to 38 gpm (.19 to 145 lpm)
 - CX, CRC, CF and D nozzles – from 2.0 to 2362 gpm (7.3 to 9010 lpm)
- Operating pressures from 3.0 to 100 psi (0.2 to 7.0 bar)

Contact your local sales engineer for information about junction boxes.



AX
1/8" to 3/4" female conn.
Slope-bottom design
Removable cap



CX
1" to 2-1/2" female conn.
Slope-bottom design
One-piece cast-type

WHIRLJET OPTIONS

S
W

BX – 1/8" to 3/4" male conn.
Slope-bottom design
Removable cap

S

CRC
1-1/4" to 4" female conn.
Two-piece cast-type

S

CF
4" to 6" flange conn.
Two-piece cast-type

S

D
1/2" to 3/4" male conn.
One-piece cast-type

**RELATIVE DROP SIZE
IN MICRONS**

10 to 100	100 to 500	500 to 1000	1000 to 5000
-----------	------------	-------------	--------------

Drop size will vary based on flow rate and pressure.

WHIRLJET® NOZZLES

HOLLOW CONE

S STANDARD ANGLE SPRAY | **W** WIDE ANGLE SPRAY

WHIRLJET AP, LAP, LBP AND E NOZZLES

- Spray angles: Standard – 43° to 91°, Wide – 112° to 120°, Extra wide – 144° to 165°
- Uniform spray distribution:
 - AP, LAP and LBP nozzles – from .14 to 18.9 gpm (.20 to 15.9 lpm)
 - E nozzles – from .11 to 16.8 gpm (.41 to 64 lpm)
- Operating pressures from 3.0 to 100 psi (0.2 to 7.0 bar)



AP
1/4" to 3/8" female conn.



E
One-piece bar stock
1/4" to 3/8" female conn.

WHIRLJET OPTIONS

LAP
3/8" to 1/2" female conn.

LBP
3/8" male conn.

E
One-piece cast-type
3/8" to 1/2" female conn.

ORDERING INFORMATION

WHIRLJET AX

Inlet Conn.	Nozzle Type	–	Material Code	Capacity Size	Example
					1/4 AX – SS 10

BSPT connections require the addition of a "B" prior to the inlet connection.

WHIRLJET AP-W (9360)

Nozzle Series No.	Inlet Conn.	Nozzle Type	–	Material Code	Capacity Size	Example
						9360 – 3/8 AP – PP 3-5W

BSPT connections require the addition of a "B" prior to the inlet connection.

WHIRLJET CF FLANGE CONNECTION

Inlet Conn.	Nozzle Type	–	Material Code	Capacity Size	Example
					6 CF – SS 550-65

BSPT connections require the addition of a "B" prior to the inlet connection.

WHIRLJET E

Inlet Conn.	Nozzle Type	–	Material Code	Capacity Size	Example
					1/4 E – SS 10

BSPT connections require the addition of a "B" prior to the inlet connection.

HOLLOW
CONE

WHIRLJET® NOZZLES

S STANDARD ANGLE SPRAY | **W** WIDE ANGLE SPRAY

QUICK REFERENCE GUIDE

Model	Connection/ Type	Connection Size (in.)	Materials	Page Number	
				Performance Data	Dimensions and Weights
AX	F	1/8 to 3/4	Brass, Mild steel (I), 303 stainless steel (SS), 316 stainless steel (316SS)	D6-D7	D15
BX	M	1/8 to 3/4		D6-D7	
AX-W	F	1/8 to 1/2		D8	
BX-W	M	1/8 to 1/2		D8	
CX	F, Cast	1 to 2-1/2	Brass, 316 stainless steel (SS)	D9	D16
CF	Flange, Cast	4 to 6		D10	
CRC	F, Cast	1-1/4 to 4		D10	
D	M, Cast	1/2 to 3/4	Brass	D11	D17
AP (9360)	F	1/4 to 3/8	Polypropylene (PP)	D11-D12	
LAP (9360)	F	3/8 to 1/2		D11-D12	
LBP (9360)	M	3/8		D11-D12	
AP-W (9360)	F	1/4 to 3/8		D13	
LAP-W (9360)	F	3/8 to 1/2		D14	
LBP-W (9360)	M	3/8		D14	
E	F	1/4 to 1/2	303 stainless steel (SS)	D14-D15	D17
E	F, Cast	3/8 to 1/2	Brass, 316 stainless steel (SS)	D14-D15	

F = female thread; M = male thread. There is no material code for brass. Leave material code blank when ordering. Other materials available upon request.
For more dimensions and sizes, contact your sales engineer.

S PERFORMANCE DATA:
STANDARD ANGLE SPRAY



Inlet Conn. (in.)	Nozzle Type		Capacity Size	Inlet Dia. Nom. (in.)	Orifice Dia. Nom. (in.)	Flow Rate Capacity (gallons per minute)										Spray Angle (°)		
	AX	BX				3 psi	5 psi	10 psi	15 psi	20 psi	30 psi	40 psi	60 psi	80 psi	100 psi	10 psi	20 psi	80 psi
1/8	●	●	.5	.031	.047	–	–	.05	.06	.07	.09	.10	.12	.14	.16	39	58	69
	●	●	1	.063	.063	–	–	.10	.12	.14	.17	.20	.24	.28	.32	41	64	76
	●	●	2	.078	.078	–	.14	.20	.24	.28	.35	.40	.49	.57	.63	52	61	69
	●	●	3	.094	.094	–	.21	.30	.37	.42	.52	.60	.73	.85	.95	52	64	77
	●	●	5	.125	.125	.27	.35	.50	.61	.71	.87	1.0	1.2	1.4	1.6	56	67	76
	●	●	8	.156	.156	.44	.57	.80	.98	1.1	1.4	1.6	2.0	2.3	2.5	56	65	70
	●	●	10	.172	.172	.55	.71	1.0	1.2	1.4	1.7	2.0	2.4	2.8	3.2	55	65	72

Intermediate capacities: Caps are interchangeable for in-between capacities within each pipe size group. Request Data Sheets 3055, 3986 and 3987.

Spray dimension data: Request Data Sheets 15350 and 15362.

Highlighted column shows the rated pressure.



PERFORMANCE DATA: STANDARD ANGLE SPRAY																		
Inlet Conn. (in.)	Nozzle Type		Capacity Size	Inlet Dia. Nom. (in.)	Orifice Dia. Nom. (in.)	Flow Rate Capacity (gallons per minute)										Spray Angle (°)		
	AX	BX				3 psi	5 psi	10 psi	15 psi	20 psi	30 psi	40 psi	60 psi	80 psi	100 psi	10 psi	20 psi	80 psi
1/4	●	●	1	.063	.063	–	–	.10	.12	.14	.17	.20	.24	.28	.32	47	53	67
	●	●	2	.078	.078	–	–	.20	.24	.28	.35	.40	.49	.57	.63	56	62	71
	●	●	3	.094	.094	–	.21	.30	.37	.42	.52	.60	.73	.85	.95	51	65	78
	●	●	5	.141	.141	.27	.35	.50	.61	.71	.87	1.0	1.2	1.4	1.6	63	73	79
	●	●	8	.156	.156	.44	.57	.80	.98	1.1	1.4	1.6	2.0	2.3	2.5	61	69	73
	●	●	10	.188	.172	.55	.71	1.0	1.2	1.4	1.7	2.0	2.4	2.8	3.2	63	70	74
	●	●	15	.234	.203	.82	1.1	1.5	1.8	2.1	2.6	3.0	3.7	4.2	4.7	63	71	72
3/8	●	●	5	.140	.125	.27	.35	.50	.61	.71	.87	1.0	1.2	1.4	1.6	64	73	79
	●	●	8	.172	.156	.44	.57	.80	.98	1.1	1.4	1.6	2.0	2.3	2.5	62	70	74
	●	●	10	.203	.172	.55	.71	1.0	1.2	1.4	1.7	2.0	2.4	2.8	3.2	64	72	75
	●	●	15	.234	.219	.82	1.1	1.5	1.8	2.1	2.6	3.0	3.7	4.2	4.7	64	72	74
	●	●	20	.281	.250	1.1	1.4	2.0	2.4	2.8	3.5	4.0	4.9	5.7	6.3	63	70	74
	●	●	25	.297	.297	1.4	1.8	2.5	3.1	3.5	4.3	5.0	6.1	7.1	7.9	63	70	74
	●	●	30	.328	.313	1.6	2.1	3.0	3.7	4.2	5.2	6.0	7.3	8.5	9.5	63	70	74
1/2	●	●	25	.375	.250	1.4	1.8	2.5	3.1	3.5	4.3	5.0	6.1	7.1	7.9	63	66	71
	●	●	30	.375	.297	1.6	2.1	3.0	3.7	4.2	5.2	6.0	7.3	8.5	9.5	67	71	75
	●	●	40	.375	.359	2.2	2.8	4.0	4.9	5.7	6.9	8.0	9.8	11.3	12.6	72	76	78
	●	●	50	.375	.438	2.7	3.5	5.0	6.1	7.1	8.7	10.0	12.2	14.1	15.8	74	79	82
	●	●	60	.375	.516	3.3	4.2	6.0	7.3	8.5	10.4	12.0	14.7	17.0	19.0	77	82	86
3/4	●	●	40	.500	.313	2.2	2.8	4.0	4.9	5.7	6.9	8.0	9.8	11.3	12.6	70	73	74
	●	●	50	.500	.344	2.7	3.5	5.0	6.1	7.1	8.7	10.0	12.2	14.1	15.8	72	75	77
	●	●	60	.500	.406	3.3	4.2	6.0	7.3	8.5	10.4	12.0	14.7	17.0	19.0	74	76	79
	●	●	70	.500	.469	3.8	4.9	7.0	8.6	9.9	12.1	14.0	17.1	19.8	22	76	79	83
	●	●	80	.500	.531	4.4	5.7	8.0	9.8	11.3	13.9	16.0	19.6	23	25	78	82	84
	●	●	90	.500	.578	4.9	6.4	9.0	11.0	12.7	15.6	18.0	22	25	28	81	84	84
	●	●	100	.500	.625	5.5	7.1	10.0	12.2	14.1	17.3	20	24	28	32	83	86	86
	●	●	110	.500	.672	6.0	7.8	11.0	13.5	15.6	19.1	22	27	31	35	85	88	88
	●	●	120	.500	.719	6.6	8.5	12.0	14.7	17.0	21	24	29	34	38	87	90	90

Intermediate capacities: Caps are interchangeable for in-between capacities within each pipe size group. Request Data Sheets 3055, 3986 and 3987.

Spray dimension data: Request Data Sheets 15350 and 15362.

Highlighted column shows the rated pressure.



HOLLOW
CONE

WHIRLJET® NOZZLES

W WIDE ANGLE SPRAY

W PERFORMANCE DATA:
WIDE ANGLE SPRAY



Inlet Conn. (in.)	Nozzle Type		Capacity Size	Inlet Dia. Nom. (in.)	Orifice Dia. Nom. (in.)	Flow Rate Capacity (gallons per minute)										Spray Angle (°)		
	AX-W	BX-W				5 psi	7 psi	10 psi	15 psi	20 psi	30 psi	40 psi	60 psi	80 psi	10 psi	20 psi	80 psi	
1/8	●	●	0.5-0.5W	.031	.047	–	–	.05	.06	.07	.09	.10	.12	.14	103	117	98	
	●	●	1-1W	.063	.063	–	–	.10	.12	.14	.17	.20	.25	.28	110	125	110	
	●	●	2-3W	.078	.109	–	.21	.25	.31	.35	.43	.50	.61	.71	114	114	97	
	●	●	3-3W	.094	.109	–	.25	.30	.37	.42	.52	.60	.73	.85	114	114	97	
	●	●	3-5W	.094	.125	–	.29	.34	.42	.48	.59	.68	.83	.96	116	110	95	
	●	●	2-10W	.078	.172	–	.35	.41	.51	.59	.72	.82	1.0	1.2	130	135	120	
	●	●	5-5W	.125	.125	–	.42	.50	.61	.71	.86	1.0	1.2	1.4	116	110	92	
	●	●	5-10W	.125	.172	.46	.54	.65	.80	.92	1.1	1.3	1.6	1.8	126	121	95	
	●	●	8-10W	.156	.172	.64	.75	.90	1.1	1.3	1.6	1.8	2.2	2.5	124	112	90	
1/4	●	●	1-1W	.063	.063	–	–	.10	.12	.14	.17	.20	.25	.28	110	117	111	
	●	●	1-5W	.063	.125	–	–	.17	.21	.24	.29	.34	.42	.48	100	123	124	
	●	●	1-10W	.063	.172	–	–	.21	.26	.30	.36	.42	.51	.60	140	144	139	
	●	●	1-15W	.063	.219	–	–	.24	.29	.34	.42	.48	.59	.68	105	128	132	
	●	●	2-5W	.078	.125	–	.29	.34	.42	.49	.60	.68	.84	.89	118	123	113	
	●	●	2-10W	.078	.172	–	.35	.41	.51	.59	.72	.82	1.0	1.2	138	136	126	
	●	●	5-5W	.141	.125	–	.42	.50	.61	.71	.86	1.0	1.2	1.4	114	113	104	
	●	●	5-10W	.141	.172	.46	.54	.65	.80	.92	1.1	1.3	1.6	1.8	130	130	119	
	●	●	5-15W	.141	.219	.52	.64	.77	.94	1.1	1.3	1.5	1.8	2.2	130	132	120	
	●	●	8-10W	.156	.172	.64	.75	.90	1.1	1.3	1.6	1.8	2.2	2.5	129	122	103	
	●	●	10-10W	.188	.172	.71	.84	1.0	1.2	1.4	1.7	2.0	2.5	2.8	120	108	95	
	●	●	8-15W	.156	.219	.78	.92	1.1	1.4	1.6	1.9	2.2	2.7	3.1	129	122	107	
	●	●	10-15W	.188	.219	.86	1.0	1.2	1.5	1.7	2.1	2.4	3.0	3.4	120	108	97	
●	●	15-15W	.234	.219	1.1	1.3	1.5	1.8	2.1	2.6	3.0	3.7	4.2	101	95	88		
3/8	●	●	5-10W	.141	.172	.46	.54	.65	.80	.92	1.1	1.3	1.6	1.8	130	123	102	
	●	●	5-15W	.141	.219	.52	.64	.77	.94	1.1	1.3	1.5	1.8	2.2	138	131	112	
	●	●	8-10W	.172	.172	.64	.75	.90	1.1	1.3	1.6	1.8	2.2	2.5	122	110	96	
	●	●	10-10W	.203	.172	.71	.84	1.0	1.2	1.4	1.7	2.0	2.5	2.8	116	108	93	
	●	●	8-15W	.172	.219	.78	.92	1.1	1.4	1.6	1.9	2.2	2.7	3.1	133	120	105	
	●	●	10-15W	.203	.219	.86	1.0	1.2	1.5	1.7	2.1	2.4	3.0	3.4	126	115	100	
	●	●	8-25W	.172	.297	.92	1.1	1.3	1.6	1.9	2.3	2.6	3.2	3.7	122	118	109	
	●	●	10-20W	.203	.234	.97	1.1	1.4	1.7	1.9	2.4	2.7	3.3	3.9	118	112	102	
	●	●	15-15W	.234	.219	1.1	1.3	1.5	1.8	2.1	2.6	3.0	3.7	4.2	116	106	95	
	●	●	15-20W	.234	.234	1.2	1.5	1.7	2.1	2.5	3.0	3.5	4.3	4.9	113	108	98	
	●	●	20-20W	.281	.234	1.4	1.7	2.0	2.4	2.8	3.5	4.0	4.9	5.6	106	102	95	
	●	●	15-30W	.234	.313	1.6	1.8	2.2	2.7	3.1	3.8	4.4	5.4	6.2	116	110	102	
	●	●	25-25W	.297	.297	1.8	2.1	2.5	3.1	3.5	4.3	5.0	6.1	7.1	105	100	93	
●	●	25-30W	.297	.313	2.0	2.3	2.8	3.4	4.0	4.9	5.6	6.9	7.9	105	101	94		
1/2	●	●	50-50W	.375	.438	3.5	4.2	5.0	6.1	7.1	8.6	10.0	12.3	14.2	110	102	93	

Intermediate capacities: Caps are interchangeable for in-between capacities within each pipe size group. Request Data Sheets 3055, 3986 and 3987.

Spray dimension data: Request Data Sheets 15350 and 15362.

Highlighted column shows the rated pressure.



S PERFORMANCE DATA:
STANDARD ANGLE SPRAY

Inlet Conn. (in.)	Nozzle Type CX	Capacity Size	Inlet Dia. Nom. (in.)	Orifice Dia. Nom. (in.)	Flow Rate Capacity (gallons per minute)												Spray Angle (°)		
					3 psi	4 psi	5 psi	7 psi	10 psi	15 psi	20 psi	30 psi	40 psi	60 psi	80 psi	100 psi	7 psi	20 psi	60 psi
1	●	7	.688	.453	4.6	5.3	5.9	7.0	8.4	10.2	11.8	14.5	16.7	20	24	26	64	65	66
	●	8	.688	.500	5.2	6.0	6.8	8.0	9.6	11.7	13.5	16.6	19.1	23	27	30	65	66	67
	●	9	.688	.563	5.9	6.8	7.6	9.0	10.8	13.2	15.2	18.6	22	26	30	34	66	67	69
	●	10	.688	.609	6.5	7.6	8.5	10.0	12.0	14.6	16.9	21	24	29	34	38	67	69	71
	●	12	.688	.672	7.9	9.1	10.1	12.0	14.3	17.6	20	25	29	35	41	45	70	73	75
	●	15	.688	.813	9.8	11.3	12.7	15.0	17.9	22	25	31	36	44	51	57	76	79	81
1-1/4	●	10	.844	.563	6.5	7.6	8.5	10.0	12.0	14.6	16.9	21	24	29	34	38	65	67	67
	●	12	.844	.641	7.9	9.1	10.1	12.0	14.3	17.6	20	25	29	35	41	45	68	70	71
	●	14	.844	.719	9.2	10.6	11.8	14.0	16.7	20	24	29	33	41	47	53	71	73	75
	●	16	.844	.797	10.5	12.1	13.5	16.0	19.1	23	27	33	38	47	54	60	74	75	77
	●	20	.844	.953	13.1	15.1	16.9	20	24	29	34	41	48	59	68	76	76	77	79
1-1/2	●	16	1.094	.688	10.5	12.1	13.5	16.0	19.1	23	27	33	38	47	54	60	64	67	69
	●	20	1.094	.859	13.1	15.1	16.9	20	24	29	34	41	48	59	68	76	69	72	74
	●	25	1.094	1.016	16.4	18.9	21	25	30	37	42	52	60	73	85	94	72	74	76
	●	30	1.094	1.125	19.6	23	25	30	36	44	51	62	72	88	101	113	74	76	78
2	●	30	1.438	.938	19.6	23	25	30	36	44	51	62	72	88	101	113	66	67	70
	●	35	1.438	1.063	23	26	30	35	42	51	59	72	84	102	118	132	68	70	73
	●	40	1.438	1.188	26	30	34	40	48	59	68	83	96	117	135	151	70	72	75
	●	45	1.438	1.297	29	34	38	45	54	66	76	93	108	132	152	170	72	74	78
	●	50	1.438	1.422	33	38	42	50	60	73	85	104	120	146	169	189	74	77	82
	●	60	1.438	1.563	39	45	51	60	72	88	101	124	143	176	203	227	77	79	84
2-1/2	●	60	1.875	1.422	39	45	51	60	72	88	101	124	143	176	203	227	67	68	71
	●	70	1.875	1.594	46	53	59	70	84	102	118	145	167	205	237	265	69	71	74
	●	80	1.875	1.734	52	60	68	80	96	117	135	166	191	234	270	302	71	73	77
	●	90	1.875	1.875	59	68	76	90	108	132	152	186	215	263	304	340	73	75	80
	●	100	1.875	2.000	65	76	85	100	120	146	169	207	239	293	338	378	77	79	83

Highlighted column shows the rated pressure.



**HOLLOW
CONE**

WHIRLJET® NOZZLES

S STANDARD ANGLE SPRAY

**S PERFORMANCE DATA:
STANDARD ANGLE SPRAY**

Inlet Conn. (in.)	Nozzle Type		Capacity Size	Inlet Dia. Nom. (in.)	Orifice Dia. Nom. (in.)	Flow Rate Capacity (gallons per minute)										Spray Angle (°)		
	CF	CRC				3 psi	5 psi	7 psi	10 psi	20 psi	30 psi	40 psi	60 psi	80 psi	100 psi	7 psi	20 psi	60 psi
1-1/4		●	10-45	.844	.516	6.5	8.5	10.0	12.0	16.9	21	24	29	34	38	45	49	52
		●	12-45	.844	.563	7.9	10.1	12.0	14.3	20	25	29	35	41	45	45	49	51
		●	14-45	.844	.656	9.2	11.8	14.0	16.7	24	29	33	41	47	53	45	48	51
		●	16-45	.844	.750	10.5	13.5	16.0	19.1	27	33	38	47	54	60	45	48	50
		●	20-45	.844	.875	13.1	16.9	20	24	34	41	48	59	68	76	45	47	49
2		●	30-45	1.438	.938	19.6	25	30	36	51	62	72	88	101	113	45	49	52
		●	35-45	1.438	1.063	23	30	35	42	59	72	84	102	118	132	45	49	51
		●	40-45	1.438	1.188	26	34	40	48	68	83	96	117	135	151	45	48	50
		●	45-45	1.438	1.266	29	38	45	54	76	93	108	132	152	170	45	48	50
		●	50-45	1.438	1.375	33	42	50	60	85	104	120	146	169	189	45	47	49
		●	55-45	1.438	1.453	36	46	55	66	93	114	131	161	186	208	45	47	49
3		●	70	2.250	1.375	46	59	70	84	118	145	167	205	237	265	65	66	69
		●	85	2.250	1.578	56	72	85	102	144	176	203	249	287	321	67	68	71
		●	100	2.250	1.750	65	85	100	120	169	207	239	293	338	378	69	72	74
		●	120	2.250	2.063	79	101	120	143	203	248	287	351	406	454	71	73	77
		●	140	2.250	2.313	92	118	140	167	237	290	335	410	473	529	73	75	80
		●	70-45	2.250	1.375	46	59	70	84	118	145	167	205	237	265	45	49	52
		●	85-45	2.250	1.578	56	72	85	102	144	176	203	249	287	321	45	49	51
		●	100-45	2.250	1.750	65	85	100	120	169	207	239	293	338	378	45	48	51
		●	120-45	2.250	2.016	79	101	120	143	203	248	287	351	406	454	45	48	50
		●	140-45	2.250	2.313	92	118	140	167	237	290	335	410	473	529	45	47	49
4	●	●	150	3.125	2.000	98	127	150	179	254	311	359	439	507	567	66	67	70
	●	●	175	3.125	2.328	115	148	175	209	296	362	418	512	592	661	68	70	71
	●	●	200	3.125	2.688	131	169	200	239	338	414	478	586	676	756	70	72	74
	●	●	225	3.125	2.938	147	190	225	269	380	466	538	659	761	850	72	74	77
	●	●	250	3.125	3.250	164	211	250	299	423	518	598	732	845	945	74	76	81
	●	●	275	3.125	3.625	180	232	275	329	465	569	657	805	930	1039	78	80	83
	●	●	150-45	3.125	2.000	98	127	150	179	254	311	359	439	507	567	45	49	52
	●	●	175-45	3.125	2.328	115	148	175	209	296	362	418	512	592	661	45	49	51
	●	●	200-45	3.125	2.688	131	169	200	239	338	414	478	586	676	756	45	48	51
	●	●	225-45	3.125	2.938	147	190	225	269	380	466	538	659	761	850	45	48	50
	●	●	250-45	3.125	3.250	164	211	250	299	423	518	598	732	845	945	45	47	49
	6	●		250	4.875	2.453	164	211	250	299	423	518	598	732	845	945	65	67
●			300	4.875	2.750	196	254	300	359	507	621	717	878	1014	1134	66	68	70
●			350	4.875	3.000	229	296	350	418	592	725	837	1025	1183	1323	68	70	72
●			400	4.875	3.250	262	338	400	478	676	828	956	1171	1352	1512	70	73	75
●			450	4.875	3.469	295	380	450	538	761	932	1076	1317	1521	1701	72	75	77
●			500	4.875	3.828	327	423	500	598	845	1035	1195	1464	1690	1890	74	76	79
●			550	4.875	4.266	360	465	550	657	930	1139	1315	1610	1859	2079	76	79	83
●			625	4.875	5.125	409	528	625	747	1056	1294	1494	1830	2113	2362	78	81	86
●			440-65	4.875	3.469	288	372	440	526	744	911	1052	1288	1487	1663	60	61	62
●			550-65	4.875	4.266	360	465	550	657	930	1139	1315	1610	1859	2079	64	65	66
●			625-65	4.875	5.125	409	528	625	747	1056	1294	1494	1830	2113	2362	65	66	67

Highlighted column shows the rated pressure.



S PERFORMANCE DATA: STANDARD ANGLE SPRAY

Inlet Conn. (in.)	Nozzle Type	Capacity Size	Inlet Dia. Nom. (in.)	Orifice Dia. Nom. (in.)	Flow Rate Capacity (gallons per minute)												Spray Angle (°)		
					3 psi	4 psi	5 psi	7 psi	10 psi	15 psi	20 psi	30 psi	40 psi	60 psi	80 psi	100 psi	10 psi	20 psi	60 psi
1/2	●	3	.438	.313	2.0	2.3	2.5	3.0	3.6	4.4	5.1	6.2	7.2	8.8	10.1	11.3	62	65	67
	●	4	.438	.391	2.6	3.0	3.4	4.0	4.8	5.9	6.8	8.3	9.6	11.7	13.5	15.1	68	71	73
	●	5	.438	.469	3.3	3.8	4.2	5.0	6.0	7.3	8.5	10.4	12.0	14.6	16.9	18.9	74	77	80
	●	7	.438	.547	4.6	5.3	5.9	7.0	8.4	10.2	11.8	14.5	16.7	20	24	26	77	80	83
3/4	●	4	.563	.359	2.6	3.0	3.4	4.0	4.8	5.9	6.8	8.3	9.6	11.7	13.5	15.1	63	66	67
	●	5	.563	.422	3.3	3.8	4.2	5.0	6.0	7.3	8.5	10.4	12.0	14.6	16.9	18.9	67	69	70
	●	6	.563	.484	3.9	4.5	5.1	6.0	7.2	8.8	10.1	12.4	14.3	17.6	20	23	71	73	77
	●	7	.563	.547	4.6	5.3	5.9	7.0	8.4	10.2	11.8	14.5	16.7	20	24	26	73	75	80
	●	10	.563	.656	6.5	7.6	8.5	10.0	12.0	14.6	16.9	21	24	29	34	38	77	80	84

Highlighted column shows the rated pressure.

S PERFORMANCE DATA: STANDARD ANGLE SPRAY

Nozzle Type/ Inlet Conn. (in.)					Capacity Size	Inlet Dia. Nom. (in.)	Orifice Dia. Nom. (in.)	Flow Rate Capacity (gallons per minute)										Spray Angle (°)		
AP		LAP		LBP				3 psi	5 psi	7 psi	10 psi	20 psi	30 psi	40 psi	60 psi	80 psi	100 psi	10 psi	20 psi	80 psi
1/4	3/8	3/8	1/2	3/8																
●	●				2	.078	.078	–	.14	.17	.20	.28	.35	.40	.49	.57	.63	53	70	80
●	●				2-3	.078	.094	–	.17	.20	.24	.34	.42	.48	.59	.68	.76	61	76	83
●	●				2-5	.078	.109	–	.20	.23	.28	.40	.48	.56	.69	.79	.89	63	81	90
●	●				2-8	.078	.141	–	.23	.28	.33	.47	.57	.66	.81	.93	1.0	71	87	95
●	●				2-10	.078	.172	–	.25	.30	.36	.51	.62	.72	.88	1.0	1.1	72	94	104
●	●				2-15	.078	.203	–	.28	.33	.39	.55	.68	.78	.96	1.1	1.2	77	100	111
●	●				2-20	.078	.234	–	.31	.37	.44	.62	.76	.88	1.1	1.2	1.4	81	103	113
●	●				3-2	.094	.078	–	.18	.22	.26	.37	.45	.52	.64	.74	.82	58	67	76
●	●				3	.094	.094	–	.21	.23	.30	.43	.52	.60	.73	.85	.95	55	79	80
●	●				3-5	.094	.109	–	.25	.30	.36	.51	.62	.72	.88	1.0	1.1	72	82	86
●	●				3-8	.094	.141	–	.31	.37	.44	.62	.76	.88	1.1	1.2	1.4	73	88	92
●	●				3-10	.094	.172	–	.34	.40	.48	.68	.83	.96	1.2	1.4	1.5	81	94	97
●	●				3-15	.094	.203	–	.39	.46	.55	.78	.95	1.1	1.3	1.6	1.7	83	93	100
●	●				3-20	.094	.234	–	.44	.52	.62	.88	1.1	1.2	1.5	1.8	2.0	90	100	107
●	●				5-2	.141	.078	–	–	–	.36	.51	.62	.72	.88	1.0	1.1	49	61	67
●	●				5-3	.141	.094	–	–	.34	.41	.58	.71	.82	1.0	1.2	1.3	57	68	69
●	●				5	.141	.109	–	.35	.42	.50	.70	.86	1.0	1.2	1.4	1.6	70	75	79
●	●				5-8	.141	.141	–	.42	.50	.60	.85	1.0	1.2	1.5	1.7	1.9	80	78	82
●	●				5-10	.141	.172	–	.48	.56	.67	1.0	1.2	1.4	1.7	1.9	2.1	80	87	89
●	●				5-15	.141	.203	–	.57	.67	.80	1.1	1.4	1.6	2.0	2.3	2.6	83	91	95
●	●				5-20	.141	.234	–	.61	.72	.86	1.2	1.5	1.7	2.1	2.4	2.7	88	98	102

Highlighted column shows the rated pressure.



**HOLLOW
CONE**

WHIRLJET® NOZZLES

S STANDARD ANGLE SPRAY

**S PERFORMANCE DATA:
STANDARD ANGLE SPRAY**

Nozzle Type/ Inlet Conn. (in.)					Capacity Size	Inlet Dia. Nom. (in.)	Orifice Dia. Nom. (in.)	Flow Rate Capacity (gallons per minute)										Spray Angle (°)		
AP		LAP		LBP				3 psi	5 psi	7 psi	10 psi	20 psi	30 psi	40 psi	60 psi	80 psi	100 psi	10 psi	20 psi	80 psi
1/4	3/8	3/8	1/2	3/8																
●	●				8-5	.172	.109	–	.42	.50	.60	.85	1.0	1.2	1.5	1.7	1.9	60	68	71
●	●				8	.172	.141	.44	.57	.67	.80	1.1	1.4	1.6	2.0	2.3	2.5	65	72	74
●	●				8-10	.172	.172	.51	.66	.79	.94	1.3	1.6	1.9	2.3	2.7	3.0	73	81	81
●	●				8-15	.172	.203	.59	.76	.90	1.1	1.5	1.9	2.2	2.6	3.1	3.4	78	84	87
●	●				8-20	.172	.234	.65	.83	.99	1.2	1.7	2.0	2.4	2.9	3.3	3.7	84	89	92
●	●				10-5	.188	.109	–	–	.54	.65	.92	1.1	1.3	1.6	1.8	2.0	55	64	67
●	●				10-8	.188	.141	–	.61	.72	.86	1.2	1.5	1.7	2.1	2.4	2.7	60	64	66
●	●				10	.188	.172	.55	.72	.84	1.0	1.4	1.7	2.0	2.4	2.8	3.1	70	76	75
●	●				10-15	.188	.203	.67	.86	1.0	1.2	1.7	2.1	2.4	3.0	3.5	3.9	76	81	79
●	●				10-20	.188	.234	.75	1.0	1.2	1.4	2.0	2.4	2.8	3.5	3.9	4.4	78	85	98
●	●				15-5	.234	.109	–	–	–	.76	1.1	1.3	1.5	1.9	2.2	2.4	52	65	60
●	●				15-8	.234	.141	–	–	.85	1.0	1.4	1.8	2.0	2.5	2.9	3.2	55	68	64
●	●				15-10	.234	.172	–	.85	1.0	1.2	1.7	2.1	2.4	2.9	3.4	3.8	65	75	71
●	●				15	.234	.203	.82	1.1	1.3	1.5	2.1	2.6	3.0	3.7	4.2	4.7	70	72	75
●	●				15-20	.234	.234	.93	1.2	1.4	1.7	2.4	2.9	3.4	4.2	4.8	5.4	78	80	82
		●			20-5	.250	.125	–	–	–	.83	1.2	1.4	1.7	2.0	2.3	2.6	33	40	55
		●			20-8	.250	.172	–	–	.90	1.1	1.5	1.9	2.2	2.6	3.1	3.4	40	47	60
		●			20-10	.250	.188	–	.97	1.2	1.4	2.0	2.4	2.8	3.4	3.9	4.4	39	55	65
		●			20-15	.250	.234	.99	1.3	1.5	1.8	2.5	3.1	3.6	4.4	5.1	5.7	55	63	68
		●			20	.250	.250	1.1	1.4	1.7	2.0	2.8	3.5	4.0	4.9	5.6	6.3	59	66	70
		●			20-25	.250	.297	1.4	1.8	2.1	2.5	3.5	4.3	5.0	6.2	7.1	7.9	60	73	77
		●			20-40	.250	.359	1.6	2.0	2.4	2.9	4.0	5.0	5.7	7.0	8.1	9.0	80	82	86
		●			20-50	.250	.438	1.9	2.5	2.9	3.5	4.9	6.1	7.0	8.5	9.9	11.0	83	90	97
		●			20-60	.250	.516	2.2	2.8	3.3	4.0	5.7	6.9	8.0	9.8	11.3	12.6	86	94	99
		●			25-8	.281	.172	–	–	–	1.2	1.7	2.1	2.4	2.9	3.4	3.8	27	42	57
		●			25-10	.281	.188	.82	1.1	1.3	1.5	2.1	2.6	3.0	3.7	4.2	4.7	35	50	59
		●			25-15	.281	.234	1.0	1.3	1.6	1.9	2.7	3.3	3.8	4.6	5.3	6.0	44	57	64
		●			25-20	.281	.250	1.2	1.5	1.8	2.2	3.1	3.7	4.3	5.3	6.1	6.8	53	63	68
		●			25	.281	.297	1.4	1.8	2.1	2.5	3.5	4.3	5.0	6.2	7.1	7.9	60	70	74
		●			25-40	.281	.359	1.7	2.2	2.7	3.2	4.5	5.5	6.4	7.8	9.0	10.1	69	73	79
		●			25-50	.281	.438	2.1	2.8	3.3	3.9	5.5	6.8	7.8	9.6	11.0	12.3	76	81	85
		●			25-60	.281	.516	2.5	3.2	3.8	4.5	6.4	7.8	9.0	11.0	12.7	14.2	83	86	92
		●	●	●	40-8	.359	.172	–	–	–	1.5	2.2	2.7	3.1	3.7	4.3	4.8	30	41	48
		●	●	●	40-10	.359	.188	–	–	1.5	1.8	2.5	3.1	3.6	4.4	5.1	5.7	34	45	53
		●	●	●	40-15	.359	.234	1.3	1.7	2.0	2.4	3.4	4.2	4.9	5.9	6.9	7.7	44	48	57
		●	●	●	40-20	.359	.250	1.5	1.9	2.2	2.7	3.8	4.6	5.3	6.5	7.5	8.4	45	52	59
		●	●	●	40-25	.359	.297	1.8	2.3	2.7	3.2	4.5	5.5	6.4	7.8	9.0	10.1	48	56	61
		●	●	●	40	.359	.359	2.2	2.8	3.3	4.0	5.7	6.9	8.0	9.8	11.3	12.6	67	71	73
		●	●	●	40-50	.359	.438	2.8	3.6	4.2	5.0	7.1	8.7	10.0	12.3	14.1	15.9	68	80	84
		●	●	●	40-50.1	.359	.422	2.8	3.6	4.2	5.0	7.1	8.7	10.0	12.3	14.1	15.9	40	47	50
		●	●	●	40-60	.359	.516	3.3	4.2	5.0	6.0	8.4	10.3	11.9	14.6	16.7	18.9	80	86	90

Highlighted column shows the rated pressure.



**PERFORMANCE DATA:
WIDE ANGLE SPRAY**

Nozzle Type/ Inlet Conn. (in.)		Capacity Size	Inlet Dia. Nom. (in.)	Orifice Dia. Nom. (in.)	Flow Rate Capacity (gallons per minute)										Spray Angle (°)		
AP-W					3 psi	5 psi	7 psi	10 psi	20 psi	30 psi	40 psi	60 psi	80 psi	100 psi	7 psi	20 psi	80 psi
1/4	3/8																
●	●	2-5W	.078	.125	–	.20	.23	.28	.40	.48	.56	.69	.79	.89	126	135	131
●	●	2-8W	.078	.156	–	.22	.26	.31	.44	.54	.62	.76	.88	.98	121	133	130
●	●	2-10W	.078	.172	–	.24	.28	.34	.48	.59	.68	.83	.96	1.1	121	135	127
●	●	2-15W	.078	.219	–	.27	.32	.38	.54	.66	.76	.93	1.1	1.2	120	133	132
●	●	2-20W	.078	.234	–	.30	.35	.42	.60	.73	.84	1.0	1.2	1.3	111	132	135
●	●	3-5W	.094	.125	–	.25	.30	.36	.51	.62	.72	.88	1.0	1.1	133	131	109
●	●	3-8W	.094	.156	–	.30	.35	.42	.60	.73	.84	1.0	1.2	1.3	133	131	110
●	●	3-10W	.094	.172	–	.37	.44	.52	.74	.90	1.0	1.3	1.5	1.6	128	130	115
●	●	3-15W	.094	.219	–	.40	.47	.56	.79	.97	1.1	1.4	1.6	1.8	128	130	118
●	●	3-20W	.094	.234	–	.42	.49	.59	.83	1.0	1.2	1.5	1.7	1.9	119	134	136
●	●	5-5W	.141	.125	–	.35	.42	.50	.70	.86	1.0	1.2	1.4	1.6	125	112	98
●	●	5-8W	.141	.156	–	.42	.50	.60	.85	1.0	1.2	1.5	1.7	1.9	125	112	97
●	●	5-10W	.141	.172	–	.48	.56	.67	1.0	1.2	1.4	1.7	1.9	2.1	125	118	102
●	●	5-15W	.141	.219	–	.57	.67	.80	1.1	1.4	1.6	2.0	2.3	2.6	130	125	105
●	●	5-20W	.141	.234	–	.61	.72	.86	1.2	1.5	1.7	2.1	2.4	2.7	125	125	112
●	●	8-5W	.172	.125	–	.42	.50	.60	.85	1.0	1.2	1.5	1.7	1.9	119	102	99
●	●	8-8W	.172	.156	.44	.57	.67	.80	1.1	1.4	1.6	2.0	2.3	2.5	112	100	87
●	●	8-10W	.172	.172	.50	.64	.76	.91	1.3	1.6	1.8	2.2	2.6	2.9	115	102	90
●	●	8-15W	.172	.219	.59	.76	.90	1.1	1.5	1.9	2.2	2.6	3.1	3.4	121	110	98
●	●	8-20W	.172	.234	.65	.83	.99	1.2	1.7	2.0	2.4	2.9	3.3	3.7	121	113	106
●	●	10-5W	.188	.125	–	–	.54	.65	.92	1.1	1.3	1.6	1.8	2.0	115	98	85
●	●	10-8W	.188	.156	–	.61	.72	.86	1.2	1.5	1.7	2.1	2.4	2.7	110	95	84
●	●	10-10W	.188	.172	.55	.72	.84	1.0	1.4	1.7	2.0	2.4	2.8	3.1	111	97	89
●	●	10-15W	.188	.219	.67	.86	1.0	1.2	1.7	2.1	2.4	3.0	3.5	3.9	113	104	97
●	●	10-20W	.188	.234	.75	1.0	1.2	1.4	2.0	2.4	2.8	3.5	3.9	4.4	118	107	102
●	●	15-5W	.234	.125	–	–	–	.76	1.1	1.3	1.5	1.9	2.2	2.4	–	91	80
●	●	15-8W	.234	.156	–	–	.85	1.0	1.4	1.8	2.0	2.5	2.9	3.2	102	93	80
●	●	15-10W	.234	.172	–	.85	1.0	1.2	1.7	2.1	2.4	2.9	3.4	3.8	107	97	83
●	●	15-15W	.234	.219	.82	1.1	1.3	1.5	2.1	2.6	3.0	3.7	4.2	4.7	110	98	90
●	●	15-20W	.234	.234	.93	1.2	1.4	1.7	2.4	2.9	3.4	4.2	4.8	5.4	112	105	100

Highlighted column shows the rated pressure.



**HOLLOW
CONE**

WHIRLJET® NOZZLES

W WIDE ANGLE SPRAY

W PERFORMANCE DATA:
WIDE ANGLE SPRAY

Nozzle Type/ Inlet Conn. (in.)			Capacity Size	Inlet Dia. Nom. (in.)	Orifice Dia. Nom. (in.)	Flow Rate Capacity (gallons per minute)										Spray Angle (°)		
LAP-W		LBP-W				3 psi	5 psi	7 psi	10 psi	20 psi	30 psi	40 psi	60 psi	80 psi	100 psi	7 psi	20 psi	80 psi
3/8	1/2	3/8																
●			20-8W	.250	.172	–	–	.90	1.1	1.5	1.9	2.2	2.6	3.1	3.4	99	96	86
●			20-10W	.250	.188	–	.94	1.2	1.4	2.0	2.4	2.8	3.4	3.9	4.4	101	98	88
●			20-15W	.250	.219	.99	1.3	1.5	1.8	2.5	3.1	3.6	4.4	5.1	5.7	104	100	91
●			20-20W	.250	.250	1.1	1.4	1.7	2.0	2.8	3.5	4.0	4.9	5.6	6.3	106	101	93
●			20-25W	.250	.281	1.4	1.8	2.1	2.5	3.5	4.3	5.0	6.2	7.1	7.9	109	104	95
●			20-40W	.250	.344	1.6	2.0	2.4	2.9	4.0	5.0	5.7	7.0	8.1	9.0	110	107	98
●			20-50W	.250	.406	1.9	2.5	2.9	3.5	4.9	6.1	7.0	8.5	9.9	11.0	111	108	100
●			25-8W	.281	.172	–	–	–	1.2	1.7	2.1	2.4	2.9	3.4	3.8	–	89	78
●			25-10W	.281	.188	–	–	1.3	1.5	2.1	2.6	3.0	3.7	4.2	4.7	100	92	81
●			25-15W	.281	.219	–	1.3	1.6	1.9	2.7	3.3	3.8	4.6	5.3	6.0	102	96	85
●			25-20W	.281	.250	1.2	1.5	1.8	2.2	3.1	3.7	4.3	5.3	6.1	6.8	104	99	88
●			25-25W	.281	.281	1.4	1.8	2.1	2.5	3.5	4.3	5.0	6.2	7.1	7.9	107	102	91
●			25-40W	.281	.344	1.7	2.2	2.7	3.2	4.5	5.5	6.4	7.8	9.0	10.1	109	105	94
●			25-50W	.281	.406	2.1	2.8	3.3	3.9	5.5	6.8	7.8	9.6	11.0	12.3	110	108	99
●	●	●	40-10W	.359	.188	–	–	1.5	1.8	2.5	3.1	3.6	4.4	5.1	5.7	95	85	80
●	●	●	40-15W	.359	.219	1.3	1.7	2.0	2.4	3.4	4.2	4.9	5.9	6.9	7.7	97	88	82
●	●	●	40-20W	.359	.250	1.5	1.9	2.2	2.7	3.8	4.6	5.3	6.5	7.5	8.4	100	94	88
●	●	●	40-25W	.359	.281	1.8	2.3	2.7	3.2	4.5	5.5	6.4	7.8	9.0	10.1	103	97	91
●	●	●	40-40W	.359	.344	2.2	2.8	3.3	4.0	5.7	6.9	8.0	9.8	11.3	12.6	106	99	93
●	●	●	40-50W	.359	.406	2.8	3.6	4.2	5.0	7.1	8.7	10.0	12.3	14.1	15.9	109	101	96

Highlighted column shows the rated pressure.

W PERFORMANCE DATA:
EXTRA WIDE ANGLE SPRAY



Inlet Conn. (in.)	Nozzle Type	Capacity Size	Inlet Dia. Nom. (in.)	Orifice Dia. Nom. (in.)	Flow Rate Capacity (gallons per minute)										Spray Angle (°)			
	E Styles				3 psi	5 psi	7 psi	10 psi	15 psi	20 psi	30 psi	40 psi	60 psi	80 psi	100 psi	7 psi	20 psi	80 psi
1/4	●	2	.063	.250	–	–	–	.20	.24	.28	.35	.40	.49	.57	.63	–	165	158
	●	5	.094	.250	.27	.35	.42	.50	.61	.71	.87	1.0	1.2	1.4	1.6	164	154	147
	●	5.8	.109	.250	.32	.41	.49	.58	.71	.82	1.0	1.2	1.4	1.6	1.8	164	154	147
	●	8	.125	.313	.44	.57	.67	.80	.98	1.1	1.4	1.6	2.0	2.3	2.5	164	160	151
	●	10	.141	.313	.55	.71	.84	1.0	1.2	1.4	1.7	2.0	2.4	2.8	3.2	164	154	147

Highlighted column shows the rated pressure.



W PERFORMANCE DATA:
EXTRA WIDE ANGLE SPRAY

Inlet Conn. (in.)	Nozzle Type	Capacity Size	Inlet Dia. Nom. (in.)	Orifice Dia. Nom. (in.)	Flow Rate Capacity (gallons per minute)											Spray Angle (°)		
	E Styles				3 psi	5 psi	7 psi	10 psi	15 psi	20 psi	30 psi	40 psi	60 psi	80 psi	100 psi	7 psi	20 psi	80 psi
3/8	●	8	.109	.484	.44	.57	.67	.80	.98	1.1	1.4	1.6	2.0	2.3	2.5	164	160	157
	●	10	.125	.484	.55	.71	.84	1.0	1.2	1.4	1.7	2.0	2.4	2.8	3.2	164	160	157
	●	15	.172	.484	.82	1.1	1.3	1.5	1.8	2.1	2.6	3.0	3.7	4.2	4.7	165	163	155
	●	20	.203	.484	1.1	1.4	1.7	2.0	2.4	2.8	3.5	4.0	4.9	5.7	6.3	162	152	147
	●	25	.234	.484	1.4	1.8	2.1	2.5	3.1	3.5	4.3	5.0	6.1	7.1	7.9	162	158	154
	●	33	.266	.641	1.8	2.3	2.8	3.3	4.0	4.7	5.7	6.6	8.1	9.3	10.4	162	154	148
	●	53	.375	.641	2.9	3.7	4.4	5.3	6.5	7.5	9.2	10.6	13.0	15.0	16.8	159	152	149
1/2	●	25	.219	.641	1.4	1.8	2.1	2.5	3.1	3.5	4.3	5.0	6.1	7.1	7.9	162	158	154
	●	30	.250	.641	1.6	2.1	2.5	3.0	3.7	4.2	5.2	6.0	7.3	8.5	9.5	163	155	148
	●	40	.297	.641	2.2	2.8	3.3	4.0	4.9	5.7	6.9	8.0	9.8	11.3	12.6	160	152	144
	●	53	.375	.641	2.9	3.7	4.4	5.3	6.5	7.5	9.2	10.6	13.0	15.0	16.8	159	152	149

Highlighted column shows the rated pressure.

DIMENSIONS AND WEIGHTS

Nozzle	Nozzle Type	Inlet Conn. (in.)	L (in.)	A (in.)	B (in.)	C (in.)	E (in.)	Net Weight (oz.)
	AX (F) AX-W (F)	1/8	1.000	0.688	0.469	0.781	–	1.5
		1/4	1.250	0.875	0.531	0.906	–	2.8
		3/8	1.469	1.031	0.688	1.125	–	4.3
		1/2	1.938	1.375	0.785	1.348	–	8.8
		3/4	2.188	1.375	0.879	1.563	–	11
	BX (M) BX-W (M)	1/8	1.188	0.875	0.652	1.375	–	1.5
		1/4	1.375	1.000	0.531	1.563	–	2.5
		3/8	1.563	1.125	0.688	1.563	–	4
		1/2	1.938	1.375	0.844	1.938	–	7
		3/4	2.250	1.625	1.563	1.250	–	10.8
	CX (F)	1	2.625	1.750	1.250	1.844	0.348	11
		1-1/4	3.063	2.063	1.313	2.188	0.438	20
		1-1/2	3.688	2.438	1.500	2.875	0.563	28
		2	4.531	3.688	2.109	3.688	0.719	48
		2-1/2	5.531	3.500	2.688	4.500	0.469	68

Based on the largest/heaviest version of each type.

DIMENSIONS AND WEIGHTS

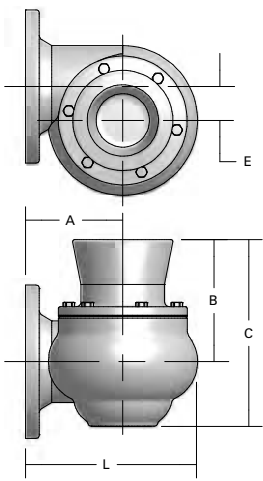
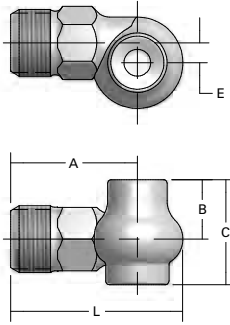
Nozzle	Nozzle Type	Inlet Conn. (in.)	L (in.)	A (in.)	B (in.)	C (in.)	E (in.)	Net Weight (oz.)
	CF (Flange)	4	8.250	4.406	9.250	12.375	1.563	114
		6	12.250	6.875	8.688	13.313	2.438	126
	CRC (F)	1-1/4	3.406	2.125	2.094	3.063	0.406	36
		2	4.844	3.188	3.063	4.656	0.719	80
		3	6.938	4.438	5.938	8.406	1.125	19
		4	9.000	5.563	9.125	12.250	1.563	40
	D (M)	1/2	2.313	1.750	0.719	1.313	0.250	5
		3/4	2.719	2.000	0.938	1.656	0.313	7.5
	AP (F) AP-W (F)	1/4	1.438	1.000	0.866	1.157	0.156	0.4
		3/8	1.469	1.094	0.866	1.157	0.156	0.4

Based on the largest/heaviest version of each type.

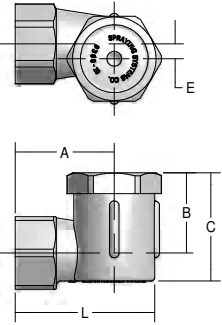
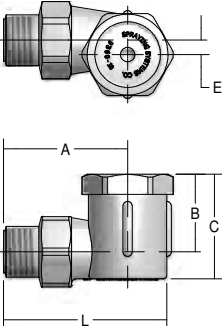
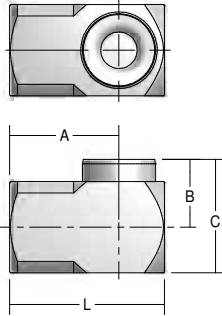
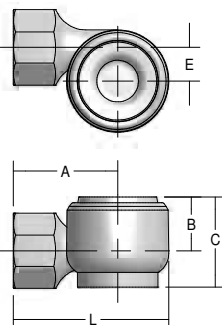

DIMENSIONS AND WEIGHTS

Nozzle	Nozzle Type	Inlet Conn. (in.)	L (in.)	A (in.)	B (in.)	C (in.)	E (in.)	Net Weight (oz.)
	LAP (F) LAP-W (F)	3/8	1.906	1.281	1.182	1.596	0.192	0.6
		1/2	2.031	1.406	1.182	1.596	0.192	0.8
	LBP (M) LBP-W (M)	3/8	2.094	1.563	1.236	1.596	0.192	0.6
	E (F)	1/4	1.250	0.875	0.500	0.750	–	2.3
		3/8	2.000	1.375	0.625	1.250	–	10.7
		1/2	2.375	1.625	0.766	1.625	–	17.3
	E (F) Cast	3/8	1.406	1.219	0.594	1.063	0.375	4.3
		1/2	2.188	1.438	0.688	1.250	0.500	6

Based on the largest/heaviest version of each type.

OVERVIEW: SPIRALJET

- Hollow cone spray pattern with a circular impact area
- Minimal clogging – maximum flow through passages of any nozzle of comparable size
- Spray angles: Standard – 50° to 180°
- Uniform spray distribution from .49 to 3320 gpm (2.0 to 11967 lpm)
- Operating pressures up to 400 psi (25 bar)
- Precision impact blade angles distribute drops and provide excellent coverage – ideal for washing, rinsing and cooling
- Compact size
- BSFJ flange-type nozzles available with reaction-bonded silicon carbide tips on FRP flanges available upon request

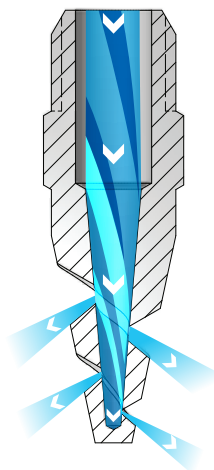

SpiralJet BSJ Nozzles

The liquid entering the nozzle passes through the orifice and exits the voids in the spiral. As it exits, the fluid deflects off the spiral surfaces to form the hollow cone pattern.

SPIRALJET OPTIONS



BSJ – 1/4" to 2" male conn.
Threaded/Hex. body style/brass



BSJ – 1/4" to 4" male conn.
Threaded/Round or flat body style/stainless steel

Custom sizes and other abrasion-resistant materials available. See Quick Reference Guide.

ORDERING INFORMATION

SPIRALJET

Inlet Conn.	Nozzle Type	–	Material Code	Spray Angle	Capacity Size	Example
						1/4 BSJ – SS 120 07

BSPT connections require the addition of a "B" prior to the inlet connection.

QUICK REFERENCE GUIDE

Model	Connection/Type	Connection Size (in.)	Materials	Page Number	
				Performance Data	Dimensions and Weights
BSJ	M, Hex.	1/4 to 2	Brass, 316 stainless steel (316SS)	D19	D19
	M, Flats	1/4 to 4	316 stainless steel (316SS)		
	M, Flats, Cast	1/4 to 4	316 stainless steel (SS)		
	M, Round	1/4 to 4	PTFE (TEF), Polyvinyl chloride (PVC)		

M = male thread. There is no material code for brass. Leave material code blank when ordering. Other materials available upon request. For more dimensions and sizes, contact your sales engineer.

RELATIVE DROP SIZE IN MICRONS

10 to 100	100 to 500	500 to 1000	1000 to 5000
-----------	------------	-------------	--------------

Drop size will vary based on flow rate and pressure.



S PERFORMANCE DATA:
STANDARD ANGLE SPRAY



Inlet Conn. (in.)	Nozzle Type	Spray Angle at 10 psi					Capacity Size	Orifice Dia. Nom. (in.)	Max. Free Passage Dia. (in.)	Flow Rate Capacity (gallons per minute)					
		BSJ	50°	60°	90°	120°				180°	5 psi	10 psi	20 psi	40 psi	100 psi
1/4	•	•	•	•	•	•	07	.094	.094	.49	.70	.99	1.4	2.2	4.4
	•	•	•	•	•	•	13	.125	.125	.92	1.3	1.8	2.6	4.1	8.2
	•	•	•	•	•	•	20	.156	.125	1.4	2.0	2.8	4.0	6.3	12.6
3/8	•	•	•	•	•	•	30	.188	.125	2.1	3.0	4.2	6.0	9.5	19.0
	•	•	•	•	•	•	40	.219	.125	2.8	4.0	5.7	8.0	12.6	25
	•	•	•	•	•	•	53	.250	.125	3.7	5.3	7.5	10.6	16.8	34
	•	•	•	•	•	•	82	.313	.125	5.8	8.2	11.6	16.4	26	52
1/2	•	•	•	•	•	•	120	.375	.188	8.5	12.0	17.0	24	38	76
	•	•	•	•	•	•	164	.438	.188	11.6	16.4	23	33	52	104
3/4	•	•	•	•	•	•	210	.500	.188	14.8	21	30	42	66	133
1	•	•	•	•	•	•	340	.625	.250	24	34	48	68	108	215
	•	•	•	•	•	•	470	.750	.250	33	47	66	94	149	297
1-1/2	•	•	•	•	•	•	640	.875	.313	45	64	91	128	202	405
	•	•	•	•	•	•	820	1.000	.313	58	82	116	164	259	519
	•	•	•	•	•	•	960	1.125	.313	68	96	136	192	304	607
2	•	•	•	•	•	•	1400	1.375	.438	99	140	198	280	443	885
	•	•	•	•	•	•	1780	1.500	.438	126	178	252	356	563	1126
3	•	•	•	•	•	•	2560	1.750	.563	181	256	362	512	810	1619
	•	•	•	•	•	•	3360	2.000	.563	238	336	475	672	1063	2125
4	•	•	•	•	•	•	5250	2.500	.625	371	525	742	1050	1660	3320

Maximum Free Passage Diameter is the maximum diameter as listed of foreign matter that can pass through the nozzle without clogging.
 For all 1/4" and 3/8" connections, optimum spray angle is achieved at 40 psi (2.8 bar).
 *Maximum operating pressure depends on material, size and application. Contact your local sales engineer for specific recommendations.
Highlighted column shows the rated pressure.

DIMENSIONS AND WEIGHTS

Nozzle	Nozzle Type	Inlet Conn. (in.)	L (in.)	Hex. / flats (in.)	Net Weight (oz.)
	BSJ (M)	1/4	1.875	9/16	1
		3/8	1.875	11/16	1.8
		1/2	2.500	7/8	3
		3/4	2.750	1-1/16	5
		1	3.625	1-3/8	11
		1-1/2	4.375	2	27
		2	6.875	2-1/2	48
		3	8.000	3-3/4	8 lbs.
		4	9.000	4-1/2	12.5 lbs.

Based on the largest/heaviest version of each type.

HOLLOW CONE

UNIJET® NOZZLES

S STANDARD ANGLE SPRAY | **W** WIDE ANGLE SPRAY

OVERVIEW: UNIJET

- Quick-connect nozzles reduce maintenance time – bodies remain on pipe/header
- Save on nozzle replacement costs – bodies can be reused, only spray tips are replaced; tips fit on male or female bodies
- Hollow cone spray pattern with a circular impact area
- Excellent atomization at relatively low pressures
- Spray angles: Standard – 13° to 114°, Wide – 130° to 140°
- Uniform spray distribution from 3.6 to 4,920 gph (13.2 to 17,760 lph)
- Operating pressures up to 400 psi (25 bar)
- Orifice inserts, cores and strainers are easily removed for inspection or cleaning
- TN versions provide very fine atomized sprays using liquid pressure alone; compressed air not required
 - Spray angles: Standard – 43° to 91°
 - Uniform spray distribution from .82 to 184 gph (3.1 to 701 lph)
 - Operating pressures up to 2000 psi (140 bar)

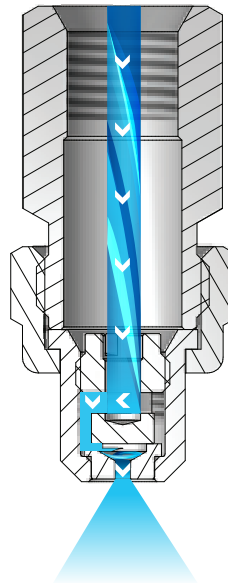

UniJet TX, D and TN Nozzles

As the liquid passes through the nozzle, it is forced to pass through slots in the orifice. These slots make the liquid spin in a circle at a high speed as it exits the orifice, creating the hollow cone pattern.

UNIJET OPTIONS

<p>S W</p> <p>Tip Retainer</p> <p>TX Spray Tip</p> <p>Strainer</p> <p>T Body</p> <p>TX Spray Tip + T Body 1/4" female conn. Use with screen strainer and tip retainer</p>	<p>S</p> <p>Tip Retainer</p> <p>D Disc</p> <p>Core</p> <p>Strainer</p> <p>TT Body</p> <p>D Spray Tip + TT Body 1/4" male conn. Disc and core type Use with slotted strainer and tip retainer</p>
--	--

<p>S</p> <p>TN Spray Tip Fine/hollow cone spray tip</p>	<p>S</p> <p>TN-SSTC Spray Tip High-pressure tungsten carbide orifice tip</p>
---	--

<p>T Body/Cap 1/8" to 1/2" female conn. Use with TX, D, T-W or TN tips</p>	<p>TT Body/Cap 1/8" to 1/2" male conn. Use with TX, D, T-W or TN tips</p>
---	--

11430 High Pressure Body
1/4" female conn.
Use with TN-SSTC tips

ORDERING INFORMATION

UNIJET

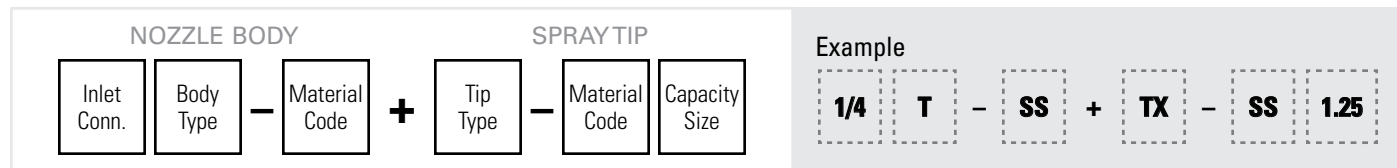

UniJet nozzle assemblies include a pre-sized wire mesh based on orifice diameter. When ordering just a UniJet spray tip, the mesh is not included. See Accessories, page F6 for a mesh selection guide and ordering information.

BSPT connections require the addition of a "B" prior to the nozzle body inlet connection.

UNIJET – DISC AND CORE TYPE

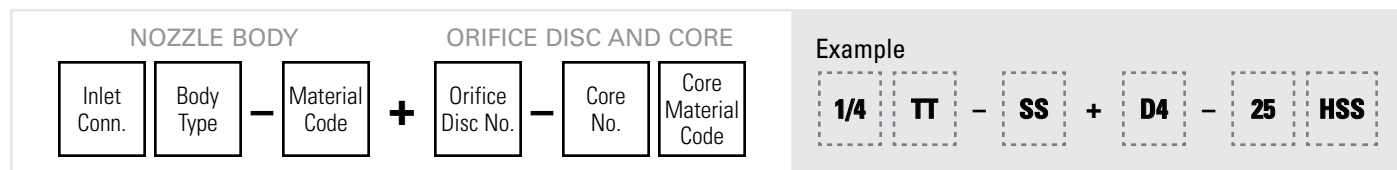

BSPT connections require the addition of a "B" prior to the nozzle body inlet connection.

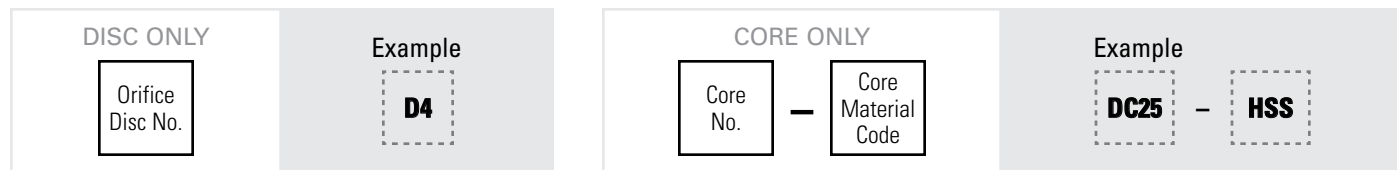

UNIJET HIGH PRESSURE

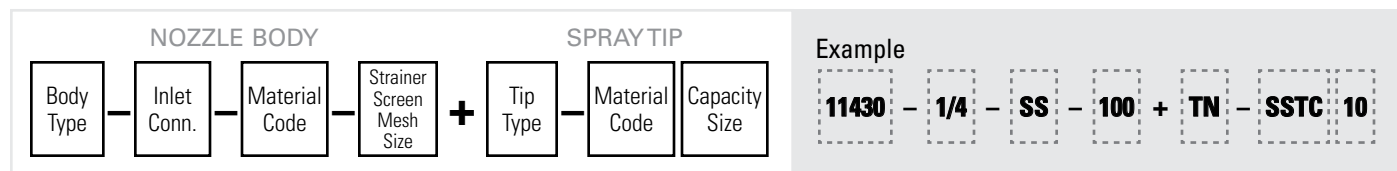

BSPT connections require the addition of a "B" prior to the nozzle body inlet connection.

QUICK REFERENCE GUIDE

Model	Connection	Connection Size (in.)	Materials	Page Number	
				Performance Data	Dimensions and Weights
T body	F	1/8 to 1/2	Brass, 303 stainless steel (SS)	-	D26
TT body	M			-	
11430 body	F	1/4	303 stainless steel (SS)	-	
TX spray tip	NA	NA	Brass, 303 stainless steel (SS)	D22	
D spray tip	NA	NA	Brass, 303 stainless steel (SS), Hardened stainless steel (HSS)	D23–D24	
T-W spray tip	NA	NA	Brass, 303 stainless steel (SS)	D22	
TN spray tip	NA	NA		D25	
TN-SSTC spray tip	NA	NA	303 stainless steel with tungsten carbide orifice (SSTC)	D25–D26	

F = female thread; M = male thread; NA = not applicable. There is no material code for brass. Leave material code blank when ordering. Other materials available upon request. For more dimensions and sizes, contact your sales engineer.

**RELATIVE DROP SIZE
IN MICRONS**



Drop size will vary based on flow rate and pressure.

S PERFORMANCE DATA:
STANDARD ANGLE SPRAY

Body Inlet Conn. (in.)	UniJet Tip Type	Capacity Size	Inlet Openings (in.)	Orifice Dia. Nom. (in.)	Flow Rate Capacity (gallons per hour)										Spray Angle (°)	
					20 psi	30 psi	40 psi	60 psi	80 psi	100 psi	150 psi	200 psi	400 psi	20 psi	40 psi	
1/4	●	.60	One .012 x .010	.014	–	–	–	.73	.85	.95	1.2	1.3	1.9	–	–	
	●	1	One .016 x .015	.020	–	.87	1.0	1.2	1.4	1.6	1.9	2.2	3.2	–	54	
	●	1.25	One .020 x .020	.022	–	1.1	1.3	1.5	1.8	2.0	2.4	2.8	4.0	–	59	
	●	1.5	One .024 x .020	.024	–	1.3	1.5	1.8	2.1	2.4	2.9	3.4	4.7	–	63	
	●	2	One .028 x .024	.028	1.4	1.7	2.0	2.4	2.8	3.2	3.9	4.5	6.3	40	68	
	●	2.5	One .030 x .029	.031	1.8	2.2	2.5	3.1	3.5	4.0	4.8	5.6	7.9	48	70	
	●	3	One .036 x .034	.034	2.1	2.6	3.0	3.7	4.2	4.7	5.8	6.7	9.5	57	72	
	●	4	One .040 x .034	.041	2.8	3.5	4.0	4.9	5.7	6.3	7.7	8.9	12.6	61	73	
	●	5	Two .032 x .032	.044	3.5	4.3	5.0	6.1	7.1	7.9	9.7	11.2	15.8	63	73	
	●	6	Two .040 x .032	.047	4.2	5.2	6.0	7.3	8.5	9.5	11.6	13.4	19.0	65	74	
	●	8	Two .040 x .036	.055	5.7	6.9	8.0	9.8	11.3	12.6	15.5	17.9	25	66	74	
	●	10	Two .050 x .030	.060	7.1	8.7	10.0	12.2	14.1	15.8	19.4	22	32	68	75	
	●	12	Two .050 x .034	.067	8.5	10.4	12.0	14.7	17.0	19.0	23	27	38	69	76	
	●	14	Two .055 x .034	.070	9.9	12.1	14.0	17.1	19.8	22	27	31	44	70	76	
	●	18	Two .060 x .031	.079	12.7	15.6	18.0	22	25	28	35	40	57	71	77	
	●	22	Two .065 x .030	.086	15.6	19.1	22	27	31	35	43	49	70	71	78	
●	26	Two .065 x .030	.094	18.4	23	26	32	37	41	50	58	82	72	78		

Spray angle of all above tips is 80° at 100 psi (7 bar).

Other body types may be available. Contact your sales engineer for more information.

Highlighted column shows the rated pressure.

W PERFORMANCE DATA:
WIDE ANGLE SPRAY

Body Inlet Conn. (in.)	UniJet Tip Type	Capacity Size	Inlet Openings (in.)	Orifice Dia. Nom. (in.)	Flow Rate Capacity (gallons per hour)										Spray Angle (°)		
					10 psi	15 psi	20 psi	30 psi	40 psi	60 psi	80 psi	100 psi	20 psi	40 psi	80 psi		
1/4	●	T2W	Two .016 x .015	.031	–	–	1.4	1.7	2.0	2.4	2.8	3.2	130	140	136		
	●	T3W	Two .020 x .019	.039	–	1.8	2.1	2.6	3.0	3.7	4.2	4.7	138	140	137		
	●	T4W	Two .024 x .021	.044	–	2.4	2.8	3.5	4.0	4.9	5.7	6.3	140	140	138		
	●	T5W	Two .028 x .027	.050	2.5	3.1	3.5	4.3	5.0	6.1	7.1	7.9	140	140	138		
	●	T6W	Two .032 x .026	.055	3.0	3.7	4.2	5.2	6.0	7.3	8.5	9.5	140	140	138		
	●	T8W	Two .036 x .029	.063	4.0	4.9	5.7	6.9	8.0	9.8	11.3	12.6	140	140	136		
	●	T10W	Two .040 x .030	.070	5.0	6.1	7.1	8.7	10.0	12.2	14.1	15.8	140	140	136		
	●	T12W	Two .044 x .029	.078	6.0	7.3	8.5	10.4	12.0	14.7	17.0	19.0	140	140	136		

Other body types may be available. Contact your sales engineer for more information.

Highlighted column shows the rated pressure.



S PERFORMANCE DATA:
STANDARD ANGLE SPRAY

Body Inlet Conn. (in.)	UniJet Tip Type	Orifice Disc No. – Core No.	Orifice Dia. Nom. (in.)	Flow Rate Capacity (gallons per minute)										Spray Angle (°)		
				10 psi	20 psi	30 psi	40 psi	60 psi	80 psi	100 psi	150 psi	200 psi	300 psi	20 psi	40 psi	80 psi
1/4	●	D1-13	.031	–	–	.06	.07	.08	.09	.10	.12	.13	.15	–	51	62
	●	D1.5-13	.036	–	.06	.07	.08	.09	.10	.11	.13	.14	.17	38	55	66
	●	D2-13	.041	–	.06	.08	.08	.10	.11	.12	.14	.16	.18	49	67	72
	●	D3-13	.047	–	.07	.08	.09	.11	.12	.13	.16	.18	.20	53	70	75
	●	D4-13	.063	.07	.09	.11	.12	.14	.16	.17	.20	.23	.27	69	79	83
	●	D1-23	.031	–	–	.06	.07	.08	.10	.11	.12	.14	.16	–	47	58
	●	D1.5-23	.036	–	.06	.08	.09	.10	.12	.13	.16	.18	.21	34	51	62
	●	D2-23	.041	–	.08	.09	.10	.13	.14	.16	.19	.21	.25	51	63	70
	●	D3-23	.047	.07	.09	.10	.12	.14	.16	.18	.21	.24	.28	58	69	75
	●	D4-23	.063	.08	.11	.14	.15	.19	.21	.23	.28	.32	.38	68	82	87
	●	D5-23	.078	.10	.13	.16	.18	.22	.25	.28	.34	.38	.46	79	89	94
	●	D6-23	.094	.11	.15	.19	.21	.26	.29	.32	.39	.45	.54	84	93	98
	●	D1-25	.031	–	–	.09	.10	.12	.14	.16	.19	.21	.26	–	27	43
	●	D1.5-25	.036	–	–	.12	.14	.16	.19	.21	.25	.28	.33	–	38	49
	●	D2-25	.041	–	.12	.14	.16	.19	.22	.25	.29	.34	.41	39	51	58
	●	D3-25	.047	.10	.14	.17	.19	.23	.26	.29	.35	.40	.48	52	61	67
	●	D4-25	.063	.15	.21	.25	.29	.35	.40	.45	.54	.62	.75	67	74	80
	●	D5-25	.078	.18	.25	.30	.35	.42	.48	.54	.65	.75	.90	73	79	84
	●	D6-25	.094	.23	.32	.39	.44	.54	.62	.70	.85	.97	1.2	79	85	89
	●	D7-25	.109	.26	.37	.45	.52	.63	.73	.81	.98	1.2	1.4	85	91	93
●	D8-25	.125	.31	.43	.53	.61	.75	.89	.97	1.2	1.4	1.7	91	96	97	
●	D10-25	.156	.38	.54	.65	.76	.93	1.1	1.2	1.5	1.7	2.1	97	102	103	
●	D12-25	.188	.46	.61	.80	.93	1.2	1.3	1.5	1.8	2.1	2.6	103	109	112	
●	D14-25	.219	.51	.72	.88	1.0	1.3	1.5	1.7	2.0	2.3	2.9	108	113	114	

For nozzles using Orifice Disc Nos. 1, 1.5 and 2 or Core Nos. 13 and 23, Slotted Strainer No. 4514-20 equivalent to 25 mesh screen size is supplied. For all other larger capacity Discs and Cores, Slotted Strainer No. 4514-32 equivalent to 16 mesh screen size is supplied.

Other body types may be available. Contact your sales engineer for more information.

For additional information see Data Sheet 4498-1.

Highlighted column shows the rated pressure.



S PERFORMANCE DATA:
STANDARD ANGLE SPRAY

Body Inlet Conn. (in.)	UniJet Tip Type	Orifice Disc No. – Core No.	Orifice Dia. Nom. (in.)	Flow Rate Capacity (gallons per minute)										Spray Angle (°)		
				10 psi	20 psi	30 psi	40 psi	60 psi	80 psi	100 psi	150 psi	200 psi	300 psi	20 psi	40 psi	80 psi
1/4	●	D1-45	.031	–	–	–	.13	.15	.17	.19	.23	.26	.31	–	22	34
	●	D1.5-45	.036	–	–	.14	.16	.20	.23	.25	.31	.35	.43	–	33	44
	●	D2-45	.041	–	.14	.18	.20	.25	.28	.32	.38	.44	.53	32	46	55
	●	D3-45	.047	–	.17	.20	.23	.28	.33	.36	.44	.51	.62	40	53	60
	●	D4-45	.063	.18	.25	.31	.36	.43	.50	.56	.68	.78	.95	62	69	72
	●	D5-45	.078	.23	.32	.39	.45	.55	.64	.71	.86	.99	1.2	67	73	76
	●	D6-45	.094	.29	.41	.50	.58	.72	.83	.93	1.2	1.3	1.6	73	79	81
	●	D7-45	.109	.33	.48	.59	.68	.84	.97	1.1	1.4	1.6	1.9	81	86	87
	●	D8-45	.125	.41	.59	.72	.84	1.0	1.2	1.4	1.7	1.9	2.4	86	90	90
	●	D10-45	.156	.54	.77	.94	1.1	1.4	1.6	1.8	2.2	2.5	3.1	90	93	93
	●	D12-45	.188	.67	.95	1.2	1.4	1.7	2.0	2.2	2.7	3.1	3.8	97	100	102
	●	D14-45	.219	.75	1.1	1.3	1.5	1.9	2.2	2.5	3.0	3.5	4.3	101	104	105
	●	D16-45	.250	.86	1.3	1.5	1.8	2.2	2.6	2.9	3.5	4.1	5.2	108	111	112
	●	D1-46	.031	–	–	–	.15	.18	.21	.23	.28	.32	.39	–	13	15
	●	D1.5-46	.036	–	–	–	.21	.26	.30	.33	.41	.46	.56	–	15	17
	●	D2-46	.041	–	–	.24	.27	.33	.37	.42	.50	.57	.68	–	18	21
	●	D3-46	.047	–	.23	.28	.32	.39	.45	.51	.61	.70	.86	14	20	24
	●	D4-46	.063	.28	.39	.48	.56	.68	.78	.88	1.1	1.3	1.5	23	29	33
	●	D5-46	.078	.38	.54	.66	.77	.94	1.1	1.3	1.5	1.7	2.1	33	39	42
	●	D6-46	.094	.55	.78	.95	1.1	1.4	1.6	1.7	2.2	2.5	3.1	42	48	50
	●	D7-46	.109	–	.98	1.2	1.4	1.7	2.0	2.2	2.7	3.2	3.9	48	53	56
	●	D8-46	.125	–	–	1.6	1.8	2.3	2.6	2.9	3.6	4.2	5.1	–	60	62
	●	D10-46	.156	–	–	2.2	2.5	3.1	3.5	4.0	4.8	5.6	6.8	–	66	68
	●	D1-56	.031	–	–	–	–	.18	.21	.23	.28	.33	.40	–	–	13
●	D1.5-56	.036	–	–	–	–	.26	.30	.33	.41	.47	.57	–	–	15	

For nozzles using Orifice Disc Nos. 1, 1.5 and 2 or Core Nos. 13 and 23, Slotted Strainer No. 4514-20 equivalent to 25 mesh screen size is supplied. For all other larger capacity Discs and Cores, Slotted Strainer No. 4514-32 equivalent to 16 mesh screen size is supplied.

Other body types may be available. Contact your sales engineer for more information.

For additional information see Data Sheet 4498-1.

Highlighted column shows the rated pressure.



S PERFORMANCE DATA: STANDARD ANGLE SPRAY

Body Inlet Conn. (in.)	UniJet Tip Type	Capacity Size	Orifice Dia. Nom. (in.)	Core No.	Flow Rate Capacity (gallons per hour)									Spray Angle (°)			
	TN				30 psi	40 psi	60 psi	100 psi	200 psi	300 psi	500 psi	700 psi	1000 psi	40 psi	80 psi	300 psi	
1/4	●	.30	.016	106	–	–	–	–	–	–	.82	1.1	1.3	1.5	–	–	51
	●	.40	.016	108	–	–	–	–	–	–	1.1	1.4	1.7	2.0	–	–	58
	●	.60	.016	206	–	–	–	.95	1.3	1.6	2.1	2.5	3.0	–	35	65	
	●	1	.020	210	–	1.0	1.2	1.6	2.2	2.7	3.5	4.2	5.0	45	62	72	
	●	1.5	.020	216	1.3	1.5	1.8	2.4	3.4	4.1	5.3	6.3	7.5	65	70	72	
	●	2	.028	216	1.7	2.0	2.4	3.2	4.5	5.5	7.1	8.4	10.0	70	75	77	
	●	3	.028	220	2.6	3.0	3.7	4.7	6.7	8.2	10.6	12.5	15.0	65	70	73	
	●	4	.042	220	3.5	4.0	4.9	6.3	8.9	11.0	14.1	16.7	20	72	81	84	
	●	6	.042	225	5.2	6.0	7.3	9.5	13.4	16.4	21	25	30	73	79	81	
	●	8	.060	225	6.9	8.0	9.8	12.6	17.9	22	28	33	40	85	89	91	
	●	10	.064	420	8.7	10.0	12.2	15.8	22	27	35	42	50	82	84	86	
	●	12	.076	420	10.4	12.0	14.7	19.0	27	33	42	50	60	78	82	85	
	●	14	.076	421	12.1	14.0	17.1	22	31	38	49	59	70	85	88	90	
	●	18	.076	422	15.6	18.0	22	28	40	49	64	75	90	81	84	86	
	●	22	.076	625	19.1	22	27	35	49	60	78	92	110	70	72	75	
●	26	.086	625	23	26	32	41	58	71	92	109	130	73	74	77		

Other body types may be available. Contact your sales engineer for more information.

Highlighted column shows the rated pressure.

S PERFORMANCE DATA: STANDARD ANGLE SPRAY

Body Inlet Conn. (in.)	UniJet Tip Type	Capacity Size	Orifice Dia. Nom. (in.)	Flow Rate Capacity (gallons per hour)					Approximate Spray Pattern Dia. (at 1 foot distance) (in.)
	TN-SSTC			400 psi	750 psi	1000 psi	1500 psi	2000 psi	
1/4	●	.60	.016	1.9	2.6	3.0	3.7	4.2	3
	●	.80	.014	2.5	3.5	4.0	4.9	5.7	3
	●	.90	.016	2.8	3.9	4.5	5.5	6.4	3
	●	1	.020	3.2	4.3	5.0	6.1	7.1	3-1/2
	●	1.5	.020	4.7	6.5	7.5	9.2	10.6	3-1/2
	●	1.8	.025	5.7	7.8	9.0	11.0	12.7	4-1/2
	●	2	.028	6.3	8.7	10.0	12.2	14.1	4-1/2
	●	3	.028	9.5	13.0	15.0	18.4	21	6

Spray pattern diameter is based on liquid with viscosity of 20 seconds #3 Zahn Cup spraying at 1600 psi (110 bar).

Coverage will vary with viscosities and pressures. Tabulated capacities are based on water.

Other body types may be available. Contact your sales engineer for more information.

Calibration pressure = 40 psi (3 bar).



S PERFORMANCE DATA:
STANDARD ANGLE SPRAY

Body Inlet Conn. (in.)	UniJet Tip Type	Capacity Size	Orifice Dia. Nom. (in.)	Flow Rate Capacity (gallons per hour)					Approximate Spray Pattern Dia. (at 1 foot distance) (in.)
	TN-SSTC			400 psi	750 psi	1000 psi	1500 psi	2000 psi	
1/4	●	4	.042	12.6	17.3	20	24	28	8
	●	6	.042	19.0	26	30	37	42	10
	●	8	.060	25	35	40	49	57	12
	●	9	.060	28	39	45	55	64	14
	●	10	.064	32	43	50	61	71	16
	●	12	.076	38	52	60	73	85	18
	●	14	.076	44	61	70	86	99	14
	●	15	.081	47	65	75	92	106	16
	●	16	.086	51	69	80	98	113	18
	●	18	.076	57	78	90	110	127	16
	●	20	.081	63	87	100	122	141	18
	●	22	.076	70	95	110	135	156	12
	●	24	.081	76	104	120	147	170	13
●	26	.086	82	113	130	159	184	14	

Spray pattern diameter is based on liquid with viscosity of 20 seconds #3 Zahn Cup spraying at 1600 psi (110 bar).

Coverage will vary with viscosities and pressures. Tabulated capacities are based on water.

Other body types may be available. Contact your sales engineer for more information.

Calibration pressure = 40 psi (3 bar).

DIMENSIONS AND WEIGHTS

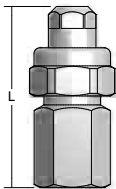
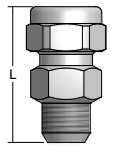
Nozzle	Nozzle Type	Inlet Conn. (in.)	L (in.)	Hex. (in.)	Net Weight (oz.)
	T (F) + TX TT (M) + TX	1/4	1.875	13/16	2.5
	T (F) + T-W TT (M) + T-W	1/4	1.875	13/16	2.5
	T (F) + D TT (M) + D	1/4	1.500	13/16	2.5

Based on the largest/heaviest version of each type.

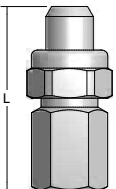
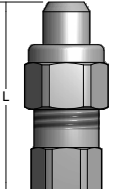
Nozzle	Nozzle Type	Inlet Conn. (in.)	L (in.)	Hex. (in.)	Net Weight (oz.)
	T (F) + TN TT (M) + TN	1/4	1.906	13/16	2.5
	T (F) + TN-SSTC TT (M) + TN-SSTC	1/4	1.906	13/16	2.5
	11430 (F) + TN-SSTC	1/4	1.938	13/16	2.6

Based on the largest/heaviest version of each type.

OVERVIEW: WHIRLJET IN-LINE, OFFSET AND DEFLECTED SPRAYS

- Hollow cone spray pattern
- In-line versions ideal for dust control in mining operations
 - BD versions have a lower profile projection for installation in a tee or pipe header
 - In-line BDM features recessed orifice area to protect from damage; self-locking cap to prevent loss due to vibration; fiberglass-reinforced nylon inlet body
- BA offset style ideal for installations with physical space limitations
- Spray angles: Standard – 43° to 94°, Wide – 102° to 125°
- Deflected spray versions available with 120°, 150° and 180° included angle of spray at 10 psi (0.7 bar)
- Uniform spray distribution from .11 to 38 gpm (.41 to 145 lpm)
- Operating pressures up to 500 psi (35 bar)

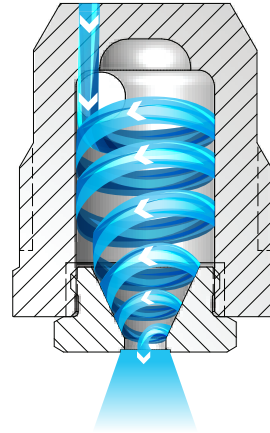

WhirlJet BD, BDM and BA Nozzles

Liquid passes through a hole on the inlet side of the nozzle. The liquid then enters a whirlchamber where it spins in a circle at high speed. The rotation forces the liquid away from the center toward the edges. This causes the liquid to exit the orifice in a hollow cone pattern.

WHIRLJET OPTIONS



BD
3/8" to 1-1/2" male conn.
In-line nozzle
Removable cap



BDM "Miner Nozzle"
3/8" male conn.
In-line nozzle
Removable cap/nylon body



BA
3/8" to 1/2" male conn.
Offset style nozzle
Removable cap



DeflectoJet® 8686
1/8" to 3/8" male conn.
Deflected nozzle
Removable deflector cap

RELATIVE DROP SIZE IN MICRONS

10 to 100

100 to 500

500 to 1000

1000 to 5000

Drop size will vary based on flow rate and pressure.



ORDERING INFORMATION

WHIRLJET BD

Inlet Conn.	Nozzle Type	—	Material Code	Capacity Size
-------------	-------------	---	---------------	---------------

Example
3/8 BD — SS 10

BSPT connections require the addition of a "B" prior to the inlet connection.

WHIRLJET BDM

Inlet Conn.	Nozzle Type	—	Capacity Size
-------------	-------------	---	---------------

Example
3/8 BDM — 5

BSPT connections require the addition of a "B" prior to the inlet connection.

WHIRLJET BA

Inlet Conn.	Nozzle Type	—	Material Code	Capacity Size
-------------	-------------	---	---------------	---------------

Example
1/2 BA — SS 25

BSPT connections require the addition of a "B" prior to the inlet connection.

DEFLECTOJET 8686

Nozzle No.	Inlet Conn.	—	Material Code	Capacity Size	—	Spray Angle
------------	-------------	---	---------------	---------------	---	-------------

Example
8686 — 1/4 — SS 1 — 120

BSPT connections require the addition of a "B" prior to the nozzle number.

QUICK REFERENCE GUIDE

Model	Connection	Connection Size (in.)	Materials	Page Number	
				Performance Data	Dimensions and Weights
BD	M	3/8 to 1-1/2	Brass, 303 stainless steel (SS)	D29	D32
BD-W	M	3/8 to 3/4	Brass, 303 stainless steel (SS)	D30	
BDM	M	3/8	Nylon/Brass cap	D30	
BA	M	3/8 to 1/2	Brass, 303 stainless steel (SS), 309 stainless steel (309SS)	D31	
8686	M	1/8 to 3/8	Brass, 303 stainless steel (SS)	D31	

M = male thread. There is no material code for brass. Leave material code blank when ordering. Other materials available upon request.
 For more dimensions and sizes, contact your sales engineer.





PERFORMANCE DATA:
STANDARD ANGLE SPRAY



Inlet Conn. (in.)	Nozzle Type BD	Capacity Size	Inlet Dia. Nom. (in.)	Orifice Dia. Nom. (in.)	Flow Rate Capacity (gallons per minute)											Spray Angle (°)		
					3 psi	5 psi	7 psi	10 psi	15 psi	20 psi	30 psi	40 psi	60 psi	80 psi	100 psi	7 psi	20 psi	80 psi
3/8	●	2	.094	.078	.11	.14	.17	.20	.24	.28	.35	.40	.49	.57	.63	51	60	70
	●	3	.094	.094	.16	.21	.25	.30	.37	.42	.52	.60	.73	.85	.95	52	64	77
	●	5	.109	.125	.27	.35	.42	.50	.61	.71	.87	1.0	1.2	1.4	1.6	56	67	76
	●	8	.156	.156	.44	.57	.67	.80	.98	1.1	1.4	1.6	2.0	2.3	2.5	56	65	70
	●	10	.156	.172	.55	.71	.84	1.0	1.2	1.4	1.7	2.0	2.4	2.8	3.2	55	65	72
	●	20-10	.156*	.172	–	4.0	1.1	1.4	1.7	1.9	2.4	2.7	3.3	3.8	4.3	61	65	67
1/2	●	5	.125	.141	.27	.35	.42	.50	.61	.71	.87	1.0	1.2	1.4	1.6	63	73	79
	●	8	.156	.156	.44	.57	.67	.80	.98	1.1	1.4	1.6	2.0	2.3	2.5	61	69	73
	●	10	.172	.172	.55	.71	.84	1.0	1.2	1.4	1.7	2.0	2.4	2.8	3.2	63	70	74
	●	15	.172*	.203	.82	1.1	1.3	1.5	1.8	2.1	2.6	3.0	3.7	4.2	4.7	60	67	70
	●	20	.188*	.234	1.1	1.4	1.7	2.0	2.4	2.8	3.5	4.0	4.9	5.7	6.3	63	65	69
	●	25	.203*	.281	1.4	1.8	2.1	2.5	3.1	3.5	4.3	5.0	6.1	7.1	7.9	59	63	68
3/4	●	5	.141	.125	.27	.35	.42	.50	.61	.71	.87	1.0	1.2	1.4	1.6	64	73	79
	●	8	.172	.156	.44	.57	.67	.80	.98	1.1	1.4	1.6	2.0	2.3	2.5	62	70	74
	●	10	.203	.172	.55	.71	.84	1.0	1.2	1.4	1.7	2.0	2.4	2.8	3.2	64	72	75
	●	15	.250	.219	.82	1.1	1.3	1.5	1.8	2.1	2.6	3.0	3.7	4.2	4.7	64	72	74
	●	20	.281	.250	1.1	1.4	1.7	2.0	2.4	2.8	3.5	4.0	4.9	5.7	6.3	63	70	74
	●	25	.281	.297	1.4	1.8	2.1	2.5	3.1	3.5	4.3	5.0	6.1	7.1	7.9	63	70	74
	●	50-50.3	.281*	.375	2.7	3.5	4.2	5.0	6.0	7.0	8.5	10.0	12.2	14.1	15.8	70	72	73
1-1/2	●	40	.375*	.313	2.2	2.8	3.3	4.0	4.9	5.7	6.9	8.0	9.8	11.3	12.6	70	73	74
	●	50	.375*	.375	2.7	3.5	4.2	5.0	6.1	7.1	8.7	10.0	12.2	14.1	15.8	72	75	77
	●	60	.375*	.438	3.3	4.2	5.0	6.0	7.3	8.5	10.4	12.0	14.7	17.0	19.0	74	76	79
	●	70	.375*	.500	3.8	4.9	5.9	7.0	8.6	9.9	12.1	14.0	17.1	19.8	22	76	79	83
	●	80	.375*	.563	4.4	5.7	6.7	8.0	9.8	11.3	13.9	16.0	19.6	23	25	78	82	84
	●	90	.375*	.578	4.9	6.4	7.5	9.0	11.0	12.7	15.6	18.0	22	25	28	81	84	84
	●	100	.375*	.625	5.5	7.1	8.4	10.0	12.2	14.1	17.3	20	24	28	32	83	86	86
	●	110	.375*	.672	6.0	7.8	9.2	11.0	13.5	15.6	19.1	22	27	31	35	85	88	88
	●	120	.375*	.719	6.6	8.5	10.0	12.0	14.7	17.0	21	24	29	34	38	87	90	90

*Dual inlets, each in diameter specified.

Highlighted column shows the rated pressure.



W PERFORMANCE DATA:
WIDE ANGLE SPRAY



Inlet Conn. (in.)	Nozzle Type BD-W	Capacity Size	Inlet Dia. Nom. (in.)	Orifice Dia. Nom. (in.)	Flow Rate Capacity (gallons per minute)											Spray Angle (°)		
					3 psi	5 psi	7 psi	10 psi	15 psi	20 psi	30 psi	40 psi	60 psi	80 psi	100 psi	7 psi	20 psi	80 psi
3/8	●	3-2W	.094	.078	-	-	.19	.22	.27	.31	.38	.44	.54	.62	.70	112	109	90
	●	3-3W	.094	.109	-	-	.25	.30	.37	.42	.52	.60	.73	.85	.95	115	112	97
	●	3-5W	.094	.125	-	-	.29	.34	.42	.48	.59	.68	.83	.96	1.1	117	113	103
	●	5-5W	.109	.125	-	-	.42	.50	.61	.71	.86	1.0	1.2	1.4	1.6	115	112	102
	●	5-10W	.109	.172	-	.46	.54	.65	.80	.92	1.1	1.3	1.6	1.8	2.1	119	119	109
	●	8-8W	.156	.156	-	.57	.67	.80	.98	1.1	1.4	1.6	2.0	2.3	2.5	116	110	98
	●	8-10W	.156	.172	-	.64	.75	.90	1.1	1.3	1.6	1.8	2.2	2.5	2.8	118	113	101
	●	10-10W	.156	.172	-	.71	.84	1.0	1.2	1.4	1.7	2.0	2.5	2.8	3.1	118	111	100
1/2	●	5-3W	.125	.109	.18	.23	.27	.32	.39	.45	.55	.64	.78	.90	1.0	118	113	100
	●	5-5W	.125	.125	.27	.35	.42	.50	.61	.71	.86	1.0	1.2	1.4	1.6	121	116	102
	●	8-8W	.156	.156	.44	.57	.67	.80	.98	1.1	1.4	1.6	2.0	2.3	2.5	119	113	103
	●	10-15W	.172	.219	.66	.86	1.0	1.2	1.5	1.7	2.1	2.4	3.0	3.4	3.8	120	112	102
	●	15-15W*	.172	.219	.82	1.1	1.3	1.5	1.8	2.1	2.6	3.0	3.8	4.2	4.8	117	111	104
3/4	●	8-25W	.172	.297	.71	.92	1.1	1.3	1.6	1.9	2.3	2.6	3.2	3.7	4.1	124	120	111
	●	10-10W	.203	.172	.55	.71	.84	1.0	1.2	1.4	1.7	2.0	2.5	2.8	3.1	118	111	100
	●	10-30W	.203	.312	1.0	1.3	1.6	1.9	2.3	2.6	3.2	3.7	4.5	5.2	5.9	124	117	108
	●	15-15W	.250	.219	.82	1.1	1.3	1.5	1.8	2.1	2.6	3.0	3.7	4.2	4.8	117	112	102
	●	15-25W	.250	.297	1.1	1.4	1.6	1.9	2.4	2.7	3.4	3.9	4.8	5.5	6.1	119	114	106
	●	20-25W	.281	.297	1.3	1.7	2.1	2.5	3.1	3.5	4.3	5.0	6.1	7.0	7.9	118	112	105
	●	20-30W	.281	.312	1.4	1.8	2.2	2.6	3.2	3.7	4.5	5.2	6.4	7.4	8.2	118	112	105
	●	25-25W	.281	.297	1.4	1.8	2.1	2.5	3.1	3.5	4.3	5.0	6.1	7.0	7.9	117	110	103
	●	25-30W	.281	.312	1.5	2.0	2.3	2.8	3.4	4.0	4.9	5.6	6.9	7.9	8.9	117	110	103

*Dual inlets, each in diameter specified.

Highlighted column shows the rated pressure.

S PERFORMANCE DATA:
STANDARD ANGLE SPRAY

Inlet Conn. (in.)	Nozzle Type BDM	Capacity Size	Orifice Dia. Nom. (in.)	Flow Rate Capacity (gallons per minute)									Spray Angle (°)		
				10 psi	20 psi	40 psi	100 psi	200 psi	300 psi	400 psi	500 psi	20 psi	100 psi	500 psi	
3/8	●	2-0.5	.047	-	-	.16	.25	.36	.44	.51	.57	-	52	45	
	●	2-1	.063	-	.16	.22	.36	.51	.62	.72	.80	53	65	50	
	●	2	.078	.20	.28	.40	.63	.89	1.1	1.3	1.4	60	69	62	
	●	3-2	.078	.22	.31	.44	.69	.98	1.2	1.4	1.6	57	68	58	
	●	3	.094	.30	.42	.60	.95	1.3	1.6	1.9	2.1	64	75	64	
	●	5	.125	.50	.71	1.0	1.6	2.2	2.7	3.2	3.5	73	78	72	
	●	10-2	.078	.35	.49	.70	1.1	1.6	1.9	2.2	2.5	30	46	40	
	●	20-10	.172	1.4	1.9	2.7	4.3	6.0	7.4	8.5	9.5	61	60	49	

Maximum recommended operating pressure is 500 psi (34.5 bar).

Highlighted column shows the rated pressure.



S PERFORMANCE DATA:
STANDARD ANGLE SPRAY



Inlet Conn. (in.)	Nozzle Type BA	Capacity Size	Inlet Dia. Nom. (in.)	Orifice Dia. Nom. (in.)	Flow Rate Capacity (gallons per minute)						Spray Angle (°)		
					5 psi	10 psi	20 psi	40 psi	60 psi	100 psi	7 psi	20 psi	80 psi
3/8	●	3	.094	.094	.21	.30	.42	.60	.73	.95	52	64	77
	●	5	.141	.125	.35	.50	.71	1.0	1.2	1.6	64	73	79
	●	8	.188	.156	.57	.80	1.1	1.6	2.0	2.5	62	70	74
	●	10	.203	.172	.71	1.0	1.4	2.0	2.4	3.2	64	72	75
	●	15	.250	.219	1.1	1.5	2.1	3.0	3.7	4.7	64	72	74
	●	20	.281	.250	1.4	2.0	2.8	4.0	4.9	6.3	63	70	74
	●	25	.297	.297	1.8	2.5	3.5	5.0	6.1	7.9	63	70	74
1/2	●	25	.375	.250	1.8	2.5	3.5	5.0	6.1	7.9	63	66	71
	●	30	.375	.297	2.1	3.0	4.2	6.0	7.3	9.5	67	71	75
	●	40	.375	.359	2.8	4.0	5.7	8.0	9.8	12.6	72	76	78
	●	50	.375	.438	3.5	5.0	7.1	10.0	12.2	15.8	74	79	82
	●	60	.375	.516	4.2	6.0	8.5	12.0	14.7	19.0	77	82	86

Highlighted column shows the rated pressure.

W PERFORMANCE DATA:
WIDE ANGLE SPRAY

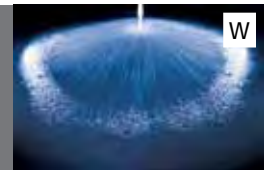

Inlet Conn. (in.)	Nozzle Type DeflectoJet® 8686	Capacity Size	Flow Rate Capacity (gallons per minute)						
			5 psi	10 psi	20 psi	40 psi	60 psi	80 psi	100 psi
1/8	●	.37	.27	.38	.53	.75	.92	1.1	1.2
	●	.5	.35	.50	.70	1.0	1.2	1.4	1.6
	●	.75	.53	.75	1.1	1.5	1.8	2.1	2.4
1/4	●	1	.71	1.0	1.4	2.0	2.5	2.8	3.2
	●	1.5	1.1	1.5	2.1	3.0	3.7	4.2	4.7
	●	2	1.4	2.0	2.8	4.0	4.9	5.6	6.3
	●	2.5	1.8	2.5	3.5	5.0	6.1	7.1	7.9
3/8	●	3	2.1	3.0	4.2	6.0	7.3	8.5	9.5
	●	3.5	2.5	3.5	5.0	7.0	8.6	9.9	11.0
	●	4	2.8	4.0	5.7	8.0	9.8	11.3	12.6
	●	4.5	3.2	4.5	6.4	9.0	11.0	12.7	14.2
	●	5	3.5	5.0	7.1	10.0	12.3	14.2	15.8

Highlighted column shows the rated pressure.

DIMENSIONS AND WEIGHTS

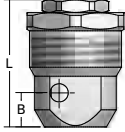
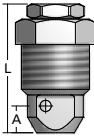
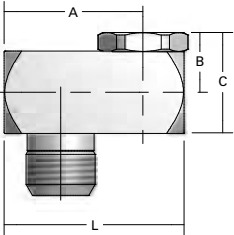
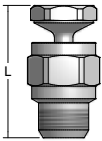
Nozzle	Nozzle Type	Inlet Conn. (in.)	L (in.)	Hex. (in.)	A (in.)	B (in.)	C (in.)	Net Weight (oz.)
	BD (M)	3/8	1.250	11/16	–	0.266	–	1
		1/2	1.469	7/8	–	0.311	–	2
		3/4	1.750	1-1/16	–	0.375	–	4
		1-1/2	2.625	2	–	0.311	–	21
	BD-W (M)	3/8	1.250	11/16	–	0.266	–	1
		1/2	1.469	7/8	–	0.311	–	2
		3/4	1.750	1-1/16	–	0.375	–	4
	BDM (M)	3/8	1.281	11/16	0.266	–	–	0.5
	BA (M)	3/8	1.500	–	1.046	0.578	0.953	4
		1/2	2.188	–	1.688	0.578	1.078	9.5
	8686 (M)	1/8	1.188	1/2	–	–	–	0.8
		1/4	1.313	5/8	–	–	–	1
		3/8	1.750	7/8	–	–	–	2.8

Based on the largest/heaviest version of each type.



FINE SPRAY NOZZLES

GAS COOLING · LIGHT MISTING
HUMIDIFYING · FOGGING
DUST CONTROL · MOISTENING
EVAPORATIVE COOLING
FIRE SUPPRESSION · AERATING
CHEMICAL PROCESSING



FINE SPRAY NOZZLES
INTRODUCTION



FULL RANGE OF HYDRAULIC ATOMIZING NOZZLES – SMALL DROPS WITHOUT COMPRESSED AIR

Styles:

- Conventional

Spray patterns:

- Standard
- Narrow
- Wide angle

Spray angles: 30° to 165°

Flow rate range: 49.2 to 8,160 gph (186 to 30,948 lph)

Operating pressure range: up to 1000 psi (69 bar)

Connections:

- 1/4" to 1-1/2" pipe sizes
- Female and male NPT and BSPT

Materials:

- Brass
- 303 stainless steel
- 316 stainless steel
- Polyvinyl chloride
- Other specialty materials available

See Trademark Registration and Ownership, page i-1.

OPTIMIZE THE PERFORMANCE OF FINE SPRAY NOZZLES:

Use a **high-pressure strainer** to protect fine spray nozzles from contaminants. Maximum operating pressure of 2000 psi at 150°F (138 bar at 66°C) and 5000 psi at 150°F (345 bar at 66°C).

See page F5



Regulate liquid pressure from 5 to 125 psi (0.3 to 8.5 bar) with our durable diaphragm-type non-relieving **liquid regulators**. Choose from brass, brass-plated zinc or stainless steel.

See page F36











CV check valves minimize pressure drop and ensure positive drip-free shut off. Choose from a wide range of inlet and outlet options and opening pressure of 5, 10 or 20 psi (0.35, 0.7 or 1.5 bar).

See page F26



FINE SPRAY NOZZLES
TABLE OF CONTENTS

HYDRAULIC ATOMIZING NOZZLES:
STANDARD AND WIDE ANGLE SPRAYS

	PAGE
 LN nozzles	E4
 LNN nozzles	E4
 LND nozzles	E4
 LNND nozzles	E4
 N nozzles	E4
 NN nozzles	E4
 M nozzles	E4
 Quick Reference Guide	E5

FOGJET® NOZZLES:
WIDE AND NARROW ANGLE SPRAYS

	PAGE
 7G nozzles	E8
 7N nozzles	E8
 FF nozzles	E8
 Quick Reference Guide	E9



FINE
SPRAY

HYDRAULIC ATOMIZING NOZZLES

S STANDARD ANGLE SPRAY | **W** WIDE ANGLE SPRAY

OVERVIEW: HYDRAULIC ATOMIZING

- Finely atomized, hollow cone spray without compressed air
- Very small drops often achieving misting performance
- Ideal for use in dust control and humidification applications
- Wall-mount options for installation on room walls, vessel bulkheads or pipeline
- Orifice inserts, cores and strainers are easily removed for inspection or cleaning
- Most models can be supplied with an internal strainer
- Spray angles: Standard – 43° to 94°, Wide – 112° to 120°
- Uniform spray distribution from .82 to 130 gph (3.1 to 492 lph)
- Operating pressures from 20 to 1000 psi (1.5 to 69 bar)

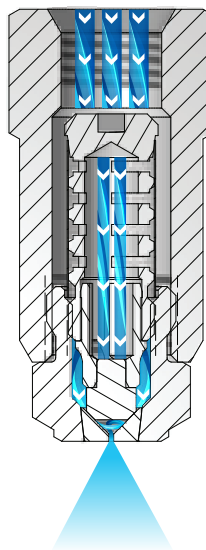

Hydraulic Atomizing Nozzles

The liquid passes through slots in the core component. The slots make the liquid spin in a circle at a very high speed. The energy from the spinning action causes the liquid to break up into very small droplets and form a hollow cone pattern as it exits the orifice.

HYDRAULIC ATOMIZING OPTIONS

S
W



LN
1/4" female conn.
Integral strainer

S
W



LNN
1/4" male conn.
Integral strainer

S



LND
1/4" female conn. with 1/2" male
wall-mounting threads
Wall-mount
Integral strainer

S



LNND
1/4" male conn. with 1/2" male
wall-mounting threads
Wall-mount
Integral strainer

S
W



N
1/4" female conn.

S
W



NN
1/4" male conn.

S



M
1/4" male conn.
Two-piece design

RELATIVE DROP SIZE
IN MICRONS

10 to 100

100 to 500

500 to 1000

1000 to 5000

Drop size will vary based on flow rate and pressure.



HYDRAULIC ATOMIZING NOZZLES

**FINE
SPRAY**

S STANDARD ANGLE SPRAY | **W** WIDE ANGLE SPRAY

ORDERING INFORMATION

HYDRAULIC ATOMIZING LN, LND, N AND M

Inlet Conn.	Nozzle Type	—	Material Code	Capacity Size	Example
					1/4 LN — SS 8

BSPT connections require the addition of a "B" prior to the inlet connection. To order M with strainer, use ML as Nozzle Type.

HYDRAULIC ATOMIZING LN AND N

Inlet Conn.	Nozzle Type	—	Material Code	Capacity Size	Example
					1/4 LN — SS 8W

BSPT connections require the addition of a "B" prior to the inlet connection.

QUICK REFERENCE GUIDE

Model	Connection/Type	Connection Size (in.)	Materials	Page Number	
				Performance Data	Dimensions and Weights
LN	F	1/4	Brass, 303 stainless steel (SS), 316 stainless steel (316SS)	E6	E7
LNN	M	1/4			
LND	F, Wall-mount	1/4	Brass, 303 stainless steel (SS)		
LNND	M, Wall-mount	1/4			
N	F	1/4	Brass, 303 stainless steel (SS), 316 stainless steel (316SS), Polyvinyl chloride (PVC)		
NN	M	1/4	Brass, 303 stainless steel (SS), 316 stainless steel (316SS)		
M	M	1/4	Brass, 303 stainless steel (SS), 316 stainless steel (316SS), Polyvinyl chloride (PVC)		
LN-W	F	1/4	Brass, 303 stainless steel (SS), 316 stainless steel (316SS)		
LNN-W	M	1/4			
N-W	F	1/4			
NN-W	M	1/4			

F = female thread; M = male thread. There is no material code for brass. Leave material code blank when ordering. Other materials available upon request. For more dimensions and sizes, contact your sales engineer.



FINE
SPRAY

HYDRAULIC ATOMIZING NOZZLES

S STANDARD ANGLE SPRAY

S PERFORMANCE DATA:
STANDARD ANGLE SPRAY



Inlet Conn. (in.)	Nozzle Type							Capacity Size	Orifice Dia. Nom. (in.)	Core No.	Flow Rate Capacity (gallons per hour)										Spray Angle (°)		
	LN	LNN	LND	LNND	N	NN	M				30 psi	40 psi	60 psi	100 psi	200 psi	300 psi	500 psi	700 psi	1000 psi	40 psi	80 psi	300 psi	
1/4	•	•						.30	.016	106	–	–	–	–	–	.82	1.1	1.3	1.5	–	–	51	
	•	•						.40	.016	108	–	–	–	–	–	1.1	1.4	1.7	2.0	–	–	58	
	•							.50	.016	109	–	–	–	–	1.1	1.4	1.8	2.1	2.5	–	–	63	
	•	•	•	•	•	•	•	.60	.016	206	–	–	–	.95	1.3	1.6	2.1	2.5	3.0	–	35	65	
	•	•	•	•	•	•	•	1	.020	210	–	1.0	1.2	1.6	2.2	2.7	3.5	4.2	5.0	45	62	72	
	•	•	•	•	•	•	•	1.5	.020	216	1.3	1.5	1.8	2.4	3.4	4.1	5.3	6.3	7.5	65	70	72	
	•	•	•	•	•	•	•	2	.028	216	1.7	2.0	2.4	3.2	4.5	5.5	7.1	8.4	10.0	70	75	77	
	•	•	•	•	•	•	•	3	.028	220	2.6	3.0	3.7	4.7	6.7	8.2	10.6	12.5	15.0	65	70	73	
	•	•	•	•	•	•	•	4	.042	220	3.5	4.0	4.9	6.3	8.9	11.0	14.1	16.7	20	72	81	84	
	•	•	•	•	•	•	•	6	.042	225	5.2	6.0	7.3	9.5	13.4	16.4	21	25	30	73	79	81	
	•	•	•	•	•	•	•	8	.060	225	6.9	8.0	9.8	12.6	17.9	22	28	33	40	85	89	91	
	•	•	•	•	•	•	•	10	.064	420	8.7	10.0	12.2	15.8	22	27	35	42	50	82	84	86	
	•	•	•	•	•	•	•	12	.076	420	10.4	12.0	14.7	19.0	27	33	42	50	60	78	82	85	
	•	•	•	•	•	•	•	14	.076	421	12.1	14.0	17.1	22	31	38	49	59	70	85	88	90	
					•	•		16	.086	421	13.9	16.0	19.6	25	36	44	57	67	80	83	86	88	
	•	•	•	•	•	•	•	18	.076	422	15.6	18.0	22	28	40	49	64	75	90	81	84	86	
	•						•	20	.081	422	17.3	20	24	32	45	55	71	84	100	75	78	80	
	•	•	•	•	•	•	•	22	.076	625	19.1	22	27	35	49	60	78	92	110	70	72	75	
•	•	•	•	•	•	•	26	.086	625	23	26	32	41	58	71	92	109	130	73	74	77		

Maximum operating pressure depends on material and application. Contact your sales engineer for details.

Highlighted column shows the rated pressure.



HYDRAULIC ATOMIZING NOZZLES

S STANDARD ANGLE SPRAY | **W** WIDE ANGLE SPRAY

**FINE
SPRAY**

W PERFORMANCE DATA:
WIDE ANGLE SPRAY



Inlet Conn. (in.)	Nozzle Type				Capacity Size	Orifice Dia. Nom. (in.)	Core No.	Flow Rate Capacity (gallons per hour)				Spray Angle (°)	
	LN-W	LNN-W	N-W	NN-W				20 psi	30 psi	40 psi	80 psi	40 psi	80 psi
1/4	●	●	●	●	2W	.039	210	–	1.7	2.0	2.8	165	158
	●	●	●	●	3W	.039	216	2.1	2.6	3.0	4.2	157	152
	●	●	●	●	4W	.060	220	2.8	3.5	4.0	5.7	156	155
	●	●	●	●	8W	.060	225	5.7	6.9	8.0	11.3	152	153

Highlighted column shows the rated pressure.

DIMENSIONS AND WEIGHTS

Nozzle	Nozzle Type	Inlet Conn. (in.)	L (in.)	Body Hex. (in.)	Cap Hex. (in.)	Net Weight (oz.)
	LN (F) LN-W (F)	1/4	1.935	13/16	5/8	3.6
	LNN (M) LNN-W (M)	1/4	2.092	13/16	5/8	3.3
	LND (F)	1/4	1.875	7/8 dia.	5/8	3.2
	LNN-D (M)	1/4	2.031	7/8 dia.	5/8	3.2

Based on the largest/heaviest version of each type.

Nozzle	Nozzle Type	Inlet Conn. (in.)	L (in.)	Body Hex. (in.)	Cap Hex. (in.)	Net Weight (oz.)
	N (F) N-W (F)	1/4	1.313	11/16	5/8	1.9
	NN (M) NN-W (M)	1/4	1.404	11/16	5/8	1.8
	M (M)	1/4	0.844	9/16	–	0.7

Based on the largest/heaviest version of each type.

**FINE
SPRAY**

FOGJET® NOZZLES

W WIDE ANGLE SPRAY | **N** NARROW ANGLE SPRAY

OVERVIEW: FOGJET

- Finely atomized sprays without use of compressed air; ideal for fogging a larger area with a single nozzle
 - 7N and 7G nozzles produce a shower-like full cone wide angle spray pattern
 - FF nozzles produce a dense, narrow, hollow cone spray pattern
- 7N and 7G assemblies include a nozzle body and seven removable caps. Each cap has an internal core or vane which is easily removed for cleaning
- Widely used in fire protection, dust control and rain simulation applications
- Uniform spray distribution from .11 to 136 gpm (.42 to 505 lpm)
- Operating pressures from 20 to 150 psi (1.5 to 10 bar)

FogJet Nozzles

The liquid passes through slots in the core component in each individual nozzle cap. The slots make the liquid spin in a circle at a very high speed. The energy from the spinning action causes the liquid to break up into very small droplets and form a hollow cone pattern as it exits the orifice.

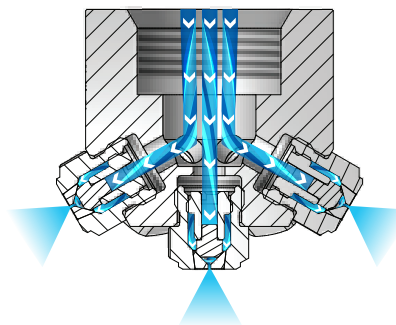

FOGJET OPTIONS



7G
 3/4" to 1-1/2" female conn.
 Optional TWD strainer



7N
 1" female conn.
 Optional TWD strainer



FF
 3/4" to 1-1/4" female conn.
 One-piece

ORDERING INFORMATION

FOGJET 7G AND 7N

Inlet Conn.	–	Nozzle Type	–	Material Code	–	Capacity Size
Example						
1-1/2	–	7G	–	SS	–	30

BSPT connections require the addition of a "B" prior to the inlet connection.

FOGJET FF

Inlet Conn.	Nozzle Type	–	Material Code	–	Capacity Size
Example					
3/4	FF	–	SS	–	4.8

BSPT connections require the addition of a "B" prior to the inlet connection.

**RELATIVE DROP SIZE
IN MICRONS**

10 to 100	100 to 500	500 to 1000	1000 to 5000
-----------	------------	-------------	--------------

Drop size will vary based on flow rate and pressure.

QUICK REFERENCE GUIDE

Model	Connection	Connection Size (in.)	Materials	Page Number	
				Performance Data	Dimensions and Weights
7N	F	1	Brass, 303 stainless steel (SS), 316 stainless steel (316SS)	E9	E12
7G	F	3/4 to 1-1/2		E10	
FF	F	3/4 to 1-1/4	Brass, 303 stainless steel (SS)	E11–E12	

F = female thread. There is no material code for brass. Leave material code blank when ordering. Other materials available upon request.
For more dimensions and sizes, contact your sales engineer.

W PERFORMANCE DATA:
WIDE ANGLE SPRAY

Inlet Conn. (in.)	Nozzle Type	Capacity Size	Dimensions			Flow Rate Capacity (gallons per minute)						
	7N		A (ft.)	B (ft.)	C (ft.)	20 psi	40 psi	60 psi	80 psi	100 psi	125 psi	150 psi
1	●	.60	3*	3-1/2	1-1/2	–	–	–	–	.11	.12	.14
	●	1	3*	4	2	–	.12	.14	.16	.18	.21	.23
	●	1.5	3*	4-1/2	2-1/2	–	.17	.21	.25	.28	.31	.34
	●	2	3*	4-1/2	2-1/2	–	.23	.29	.33	.37	.41	.45
	●	3	3*	5-1/2	3-1/2	.25	.35	.43	.50	.55	.62	.68
	●	4	3*	5-1/2	3-1/2	.33	.47	.57	.66	.74	.83	.90
	●	6	3*	6	4	.50	.70	.86	.98	1.1	1.2	1.4
	●	8	3*	6	4	.66	.93	1.1	1.3	1.5	1.7	1.8
	●	10	3*	7	4-1/2	.83	1.2	1.4	1.7	1.8	2.1	2.3
	●	12	3*	8	4-1/2	1.0	1.4	1.7	2.0	2.2	2.5	2.7
	●	14	3	8	4-1/2	1.2	1.6	2.0	2.3	2.6	2.9	3.2
	●	16	3 7*	8 7-1/2	5 5-1/2	1.3	1.9	2.3	2.6	3.0	3.3	3.6
	●	18	3 7*	8 9	5 6	1.5	2.1	2.6	3.0	3.3	3.7	4.1
	●	22	3 7*	9-1/2 11	5-1/2 7	1.8	2.6	3.2	3.6	4.1	4.5	5.0
●	26	3 7*	10 12	6 8	2.1	3.0	3.7	4.3	4.8	5.4	5.9	

*And higher.

Highlighted column shows the rated pressure.



**FINE
SPRAY**

FOGJET® NOZZLES

W WIDE ANGLE SPRAY

W PERFORMANCE DATA:
WIDE ANGLE SPRAY



Inlet Conn. (in.)	Nozzle Type	Capacity Size	Dimensions			Flow Rate Capacity (gallons per minute)						
			A (ft.)	B (ft.)	C (ft.)	20 psi	40 psi	60 psi	80 psi	100 psi	125 psi	150 psi
3/4	●	1	3 5 8 11	5 6-1/2 7-1/2 8	3-1/4 4-1/4 4-3/4 5-1/4	.98	1.3	1.6	1.8	2.1	2.3	2.5
	●	1.5	3 5 8 11	8 9 10 10-1/2	5-1/2 6-1/2 7-1/2 7-3/4	1.5	2.0	2.4	2.8	3.1	3.4	3.7
	●	3	3 5 8 11	8-1/2 10 11 11-1/2	5-1/2 6-1/2 7 7-1/2	2.9	4.0	4.8	5.5	6.2	6.8	7.4
	●	5	3 5 8 11	9-1/2 11 12 12-1/2	6-1/4 7 7-3/4 8	4.8	6.7	8.1	9.2	10.3	11.3	12.4
1	●	6.5	3 5 8 11	10 11-1/2 13 13-1/2	9 9-1/4 10 11-1/2	6.2	9.1	10.5	11.9	13.3	14.5	16.1
	●	10	3 5 8 11	11 12-1/2 13-1/2 14	9-1/2 10 11 12	9.8	13.5	16.4	18.9	21	23	25
	●	12.5	3 5 8 11	12 13-1/4 14 14-1/2	10 11 12 12-1/2	12.0	17.0	20	23	25	28	30
	●	16	3 5 8 11	12-1/2 13-3/4 14-1/2 15	10-1/2 12 13 13-1/4	15.4	22	26	30	33	37	40
1, 1-1/2	●	25	3 5 8 11	13-3/4 16 17 17-1/2	9 10-1/2 11 11-1/2	24	34	41	47	52	57	62
	●	30	3 5 8 11	13-3/4 16 17 17-1/2	9 10-1/2 11 11-1/2	29	40	48	55	62	68	74
	●	32	3 5 8 11	13-3/4 16 17 17-1/2	9 10-1/2 11 11-1/2	31	43	52	59	66	74	79
	●	40	3 5 8 11	13-3/4 16 17 17-1/2	9 10-1/2 11 11-1/2	39	53	64	74	83	92	100
1-1/2	●	45	3 5 8 11	14 16-1/2 17-1/2 18	9-1/2 11 12 12-1/2	44	60	72	82	91	100	110
	●	50	3 5 8 11	14-1/2 17 18 19	10-1/2 12 13-1/2 14	48	67	81	92	103	113	124

Highlighted column shows the rated pressure.



N

PERFORMANCE DATA:
NARROW ANGLE SPRAY



Inlet Conn. (in.)	Nozzle Type	Capacity Size	Flow Rate Capacity (gallons per minute)					
			20 psi	40 psi	60 psi	80 psi	100 psi	150 psi
3/4	●	4.8	3.4	4.8	5.9	6.8	7.6	9.3
	●	9	6.4	9.0	11.0	12.7	14.2	17.4
	●	12	8.5	12.0	14.7	17.0	19.0	23
	●	18	12.7	18.0	22	25	28	35
1	●	25	17.7	25	31	35	40	48
	●	35	25	35	43	49	55	68
1-1/4	●	50	35	50	61	71	79	97
	●	70	49	70	86	99	111	136

Highlighted column shows the rated pressure.

N

PERFORMANCE DATA:
NARROW ANGLE SPRAY

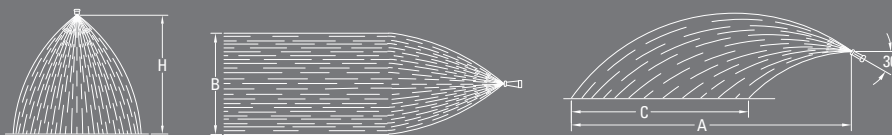

Nozzle Type	Capacity Size	"H" Height Above Floor (ft.)	Spray Dimensions and Coverage (ft.)					
			40 psi			100 psi		
			A	B*	C	A	B*	C
●	4.8	3	17	7	13	25	5	20
●	9	3	23	8	17	31	5.5	24
●	12	3	25	8	18	33	5.5	25
●	18	3	29	8	19	36	5.5	26
●	25	3	32	8	24	42	5.5	32
●	35	3	36	8	28	55	6	45
●	50	3	37	8	28	60	6	50
●	70	3	46	8	36	72	6	60

*B dimension is taken at widest portion of A.



**FINE
SPRAY**

FOGJET® NOZZLES

W WIDE ANGLE SPRAY | **N** NARROW ANGLE SPRAY

N PERFORMANCE DATA:
NARROW ANGLE SPRAY

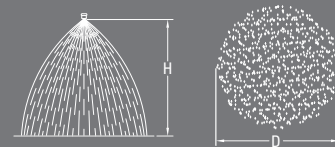

Nozzle Type	Capacity Size	"H" Height Above Floor (ft.)	Spray Coverage "D" at Various Pressures (ft.)			
			40 psi	60 psi	100 psi	150 psi
FF						
•	4.8, 9, 12	3	2	2	2	2
•		5	3	3	3	2-1/2
•		7	4	4	3-1/2	3
•		10	5	4-1/2	4	3-1/2
•	18, 25	3	2	2	2	2
•		5	3	3	3	2-1/2
•		7	4	4	3-1/2	3
•		10	5-1/2	5	4-1/4	4
•	35, 50, 70	3	2-1/2	2-1/2	2-1/2	2
•		5	4	4	3-1/2	3
•		7	5	5	4-1/2	4
•		10	6-1/2	6	5-1/2	5

DIMENSIONS AND WEIGHTS

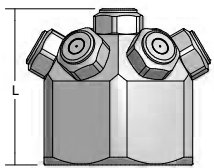
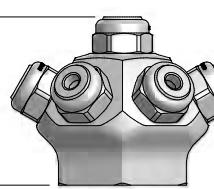
Nozzle	Nozzle Type	Inlet Conn. (in.)	L (in.)	D (Dia.) (in.)	Net Weight (oz.)
	7N (F)	1	2.094	2.500	18.3
		3/4	1.820	2.125	10.0
		1	3.313	4.063	43.3
		1-1/2	3.188	4.250	34.4

Based on the largest/heaviest version of each type.

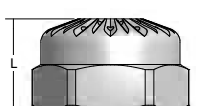
Nozzle	Nozzle Type	Inlet Conn. (in.)	L (in.)	D (Dia.) (in.)	Net Weight (oz.)
	FF (F)	3/4	1.000	1.375	3.0
		1	1.156	1.656	5.0
		1-1/4	1.218	2.094	7.0

Based on the largest/heaviest version of each type.



ACCESSORIES



ACCESSORIES
INTRODUCTION



OPTIMIZE PERFORMANCE AND SIMPLIFY INSTALLATION

Simplify Nozzle Mounting and Positioning

- Split-eyelet connectors
- Adjustable ball fittings
- Adjustable hoses and mounting bases

Options for Quick-Connect Nozzle Systems

- Strainers
- Flow stabilizers
- Metering plates
- Color-coded caps

Ensure Proper Flow Control and Regulation

- Check valves, throttling valves, pressure relief valves and more
- Air pressure regulators
- Liquid pressure regulators

Clog Prevention

- Liquid strainers
- Filtration assemblies
- Air line filters

SIMPLIFY INSTALLATION, OPERATION AND MAINTENANCE

Prevent particles and debris from obstructing flow with **nozzle and fluid line strainers**. Choose from a wide range of inlet connections, materials, mesh size and more.
See pages F4 and F16



Connect nozzles to pipes in minutes with leak-proof **split-eyelet connectors**. Connectors clamp on 1/2" to 2" pipes.
See page F23





Easily control line pressure and minimize waste with **adjustable relief valves**. Excess liquid is returned back to the liquid source or pump inlet.
See page F31





**A C C E S S O R I E S
T A B L E O F C O N T E N T S**

STRAINERS

	PAGE
 TWD, 16106, 9830 and AA122 strainers	F4
 AA124/AA430 strainers	F5
 15925, 8310A and 2820 strainers	F5



FILTRATION ASSEMBLY AND AIR LINE FILTERS

	PAGE
 39185 filtration assembly	F10
 11438 air line filters	F10



**QUICK-CONNECT NOZZLE SYSTEM OPTIONS:
ADAPTERS**

	PAGE
 QJ17560A, QJ7421, QJ1/4TT and QJ1/4T adapters	F12





**QUICK-CONNECT NOZZLE SYSTEM OPTIONS:
UNIJET® BODIES**

	PAGE
 4664B and 8360 diaphragm check valve bodies	F14
 7421 split-eyelet bodies	F14

**QUICK-CONNECT NOZZLE SYSTEM OPTIONS:
UNIJET® STRAINERS AND FILTER**

	PAGE
 5053, 6051, 8079 and 4193A strainers	F16
 4514, 4067 and 7630 strainers	F16
 9106 filter	F16



**QUICK-CONNECT NOZZLE SYSTEM OPTIONS:
UNIJET® STABILIZER, VALVE, RETAINER, PLATE
AND ADAPTERS**

	PAGE
 11370 jet stabilizer	F18
 11750 large capacity check valve	F18
 CP1325 tip retainer	F18
 4916 metering plate	F18
 4676 and 6406 adapters	F19



**QUICK-CONNECT NOZZLE SYSTEM OPTIONS:
QUICK UNIJET® ADAPTER AND CAPS**

	PAGE
 QJT adapter and caps	F21

**SPLIT-EYELET CONNECTORS AND ADJUSTABLE
BALL FITTINGS**

	PAGE
 7521, 8370 and 15475 split-eyelet connectors	F23
 36275 adjustable ball fittings	F23

CHECK VALVES

	PAGE
 AB and BB ball-type check valves	F26
 10742A and 12328 diaphragm check valves	F26
 CV series check valves	F26

PLUG AND BALL VALVES

	PAGE
 23220 plug valves	F29
 20900 ball valves	F29

THROTTLING AND PRESSURE RELIEF/REGULATING VALVES

	PAGE
 23120, 8460, 6815, 110 and 23520 valves	F31

SOLENOID VALVES

	PAGE
 2-way and 3-way valves	F34



LIQUID AND AIR PRESSURE REGULATORS

	PAGE
 11438 regulators	F36

LIQUID PRESSURE GAUGES

	PAGE
 26383 and 26385 gauges	F38

HOSES AND MOUNTING BASES

	PAGE
 57020 and 57025 stay-n-place hoses	F39
 57045 magnetic mounting bases	F39



OVERVIEW: LIQUID STRAINERS

- Liquid strainers protect nozzles, valves and pumps from damaging debris and minimize clogging
- Wire mesh options ensure screening of particulate as small as 63 microns

T-Style Strainer

T-strainers feature a removable bottom cap or plug for complete withdrawal of the screen assembly during cleaning. On some models, the bottom pipe plug can be replaced with a drain cock for quick-flush cleaning. Models with a clear nylon bowl allow easy visual inspection of the internal screen. Self-clean designs allow filtered liquid to pass through, while liquid particles are returned back to the liquid supply through a return outlet.

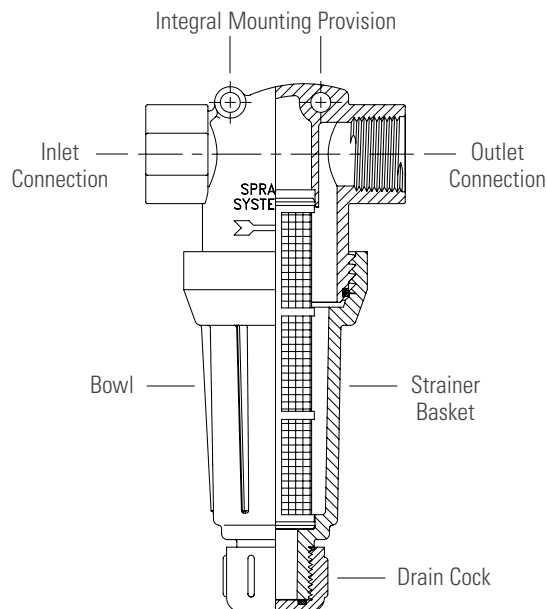

STRAINER OPTIONS

TWD

1/4", 3/8", 1/2", 3/4", 1", 1-1/4", 1-1/2", 2", 2-1/2" female conn.

Removable bottom plug for easy screen cleaning

Bottom plug can be replaced with drain cock for flush cleaning

Max. pressure: 300 psi (20 bar)

Materials: Aluminum, brass, stainless steel

Mesh: 16, 30, 50, 80, 100, 40 x 200 Dutch weave



16106

1-1/2", 2", 2-1/2" female conn.

Removable bottom plug for easy screen cleaning

Bottom plug can be replaced with drain cock for flush cleaning

Max. pressure: 200 psi (14 bar)

Materials: Brass, stainless steel

Mesh: 16, 50, 80, 100



9830

3/4", 1" female conn.

Hand removable ribbed bottom cap for easy cleaning of screen

Max. pressure: 300 psi (20 bar)

Materials: Aluminum, brass, ductile iron

Mesh: 16, 50, 100



AA122

1/2", 3/4" female conn.

Hand removable outer bowl for easy screen cleaning

Max. pressure: 150 psi at 100°F (10 bar at 38°C)

Materials: Polypropylene, polypropylene head with clear nylon bowl

Mesh: 15, 30, 50, 80, 100, 200, 40 x 200 Dutch weave



STRAINER OPTIONS

AA124/AA430

3/4", 1", 1-1/4", 1-1/2", 2", 2-1/2" female conn.*

Larger size screen area requires less frequent cleaning

Self-cleaning styles and versions with mounting lugs available

AA124 and AA430 versions are the same except for materials and inlet connections



Strainer Type	Strainer Part No.	Material**	Max. Pressure	Mesh Sizes
124	AA124-AL	Aluminum head/nylon bowl	150 psi (10 bar)	16, 30, 50, 80, 100
124ML with mounting holes***	AA124ML-AL	Aluminum head/nylon bowl	150 psi (10 bar)	16, 30, 50, 80, 100
124A self-cleaning version	AA124ASC-NYB	Aluminum head/nylon bowl	110 psi (8 bar)	16, 30, 50, 80, 100
430ML with mounting holes***	AA430ML	Polypropylene head/nylon bowl	110 psi (8 bar)	16, 30, 50, 80, 100, 120, 200****
430 self-cleaning version	AA430SC	Polypropylene head/nylon bowl	75 psi (5 bar)	16, 30, 50, 80, 100, 120, 200****

*Inlet connections vary. See pages F8 and F9.

**Max. temperature for plastic 100°F (38°C); max. temperature for metal 180°F (82°C).

***For mounting on machinery or angle iron.

****120 only for 1-1/4" and 1-1/2" sizes; 200 only for 3/4" and 1" sizes.

15925

3/4", 1" female conn.

Removable bottom plug for easy flush cleaning of screen

Max. pressure: 2000 psi at 150°F (138 bar at 66°C)

Material: Black oxide-coated mild steel body

Mesh: 50



8310A

1/4", 3/8", 1/2" female conn.

Removable bottom plug for easy flush cleaning of screen

Max. pressure: 5000 psi at 150°F (345 bar at 66°C)

Material: Stainless steel

Mesh: 16, 30, 50, 100



2820

1/4", 3/8", 1/2" female inlet conn.
1/4" female outlet conn.

Max. pressure: 5000 psi at 150°F (345 bar at 66°C)

Material: Stainless steel

Mesh: 16, 30, 50, 100



MATERIAL

CODE

Aluminum	AL
Brass	B
Ductile Iron	No code
Nylon	NYB
Polypropylene	PP
Polypropylene head/clear nylon bowl	NYC
303 stainless steel	SS
316 stainless steel	316SS

MESH SELECTION GUIDE

Mesh Size	Wire Dia. (in.)	Mesh Opening (in.)	Mesh Opening (microns)	Percentage Open Area	Orifice Dia. (in.)
16	0.016	0.045	1143	55.4	0.032 and larger
20	0.016	0.0340	864	46.2	0.032 and larger
30	0.012	0.0213	541	40.8	0.032 and larger
50	0.009	0.0110	279	30.3	0.032 and larger
60	0.0075	0.0092	234	30.5	0.019 through 0.031
80	0.0055	0.0070	177	31.4	0.019 through 0.031
100	0.0045	0.0055	140	30.3	0.019 through 0.031
120	0.0037	0.0046	118	30.1	0.019 through 0.031
200	0.0021	0.0029	74	33.6	Up through 0.018
40 x 200 Dutch Weave	0.007 x 0.005	0.003	63	–	Up through 0.018

ORDERING INFORMATION

TWD STRAINER

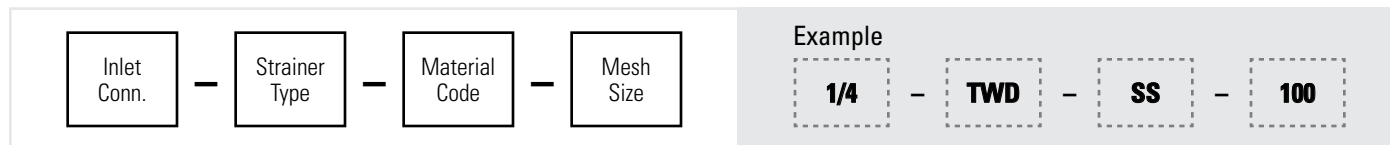

BSPT connections require the addition of a "B" prior to the inlet connection.

16106 STRAINER



BSPT connections require the addition of a "B" prior to the inlet connection.

9830 STRAINER

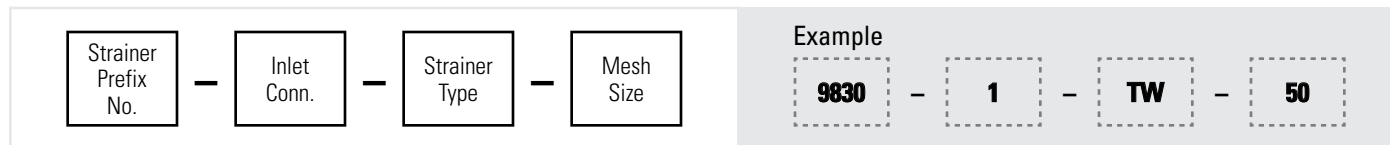

BSPT connections require the addition of a "B" prior to the inlet connection.

AA124 SELF-CLEANING STRAINER

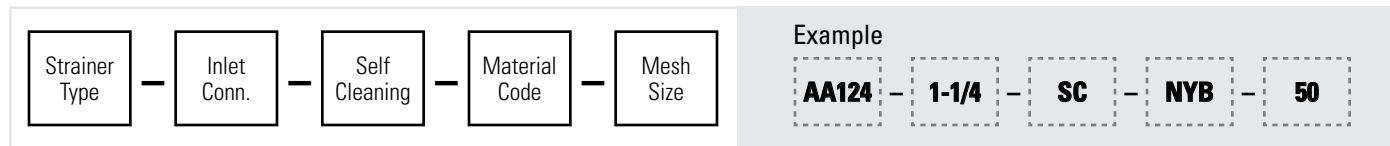

BSPT connections require the addition of a "B" prior to the inlet connection.



ORDERING INFORMATION

15925 STRAINER

<div style="display: flex; justify-content: space-around; align-items: center;"> <div style="border: 1px solid black; padding: 5px; margin: 5px;">Strainer Type</div> - <div style="border: 1px solid black; padding: 5px; margin: 5px;">Inlet Conn.</div> </div>	<p>Example</p> <div style="display: flex; justify-content: space-around; align-items: center;"> <div style="border: 1px dashed gray; padding: 5px; margin: 5px;">15925</div> - <div style="border: 1px dashed gray; padding: 5px; margin: 5px;">3/4</div> </div>
---	--

BSPT connections require the addition of a "B" prior to the inlet connection.

8310A STRAINER

<div style="display: flex; justify-content: space-around; align-items: center;"> <div style="border: 1px solid black; padding: 5px; margin: 5px;">Strainer Type</div> - <div style="border: 1px solid black; padding: 5px; margin: 5px;">Inlet Conn.</div> - <div style="border: 1px solid black; padding: 5px; margin: 5px;">Mesh Size</div> </div>	<p>Example</p> <div style="display: flex; justify-content: space-around; align-items: center;"> <div style="border: 1px dashed gray; padding: 5px; margin: 5px;">8310A</div> - <div style="border: 1px dashed gray; padding: 5px; margin: 5px;">3/8</div> - <div style="border: 1px dashed gray; padding: 5px; margin: 5px;">100</div> </div>
--	--

BSPT connections require the addition of a "B" prior to the inlet connection.

2820 STRAINER

<div style="display: flex; justify-content: space-around; align-items: center;"> <div style="border: 1px solid black; padding: 5px; margin: 5px;">Strainer Type</div> - <div style="border: 1px solid black; padding: 5px; margin: 5px;">Inlet Conn.</div> - <div style="border: 1px solid black; padding: 5px; margin: 5px;">Material Code</div> - <div style="border: 1px solid black; padding: 5px; margin: 5px;">Mesh Size</div> </div>	<p>Example</p> <div style="display: flex; justify-content: space-around; align-items: center;"> <div style="border: 1px dashed gray; padding: 5px; margin: 5px;">2820</div> - <div style="border: 1px dashed gray; padding: 5px; margin: 5px;">1/4</div> - <div style="border: 1px dashed gray; padding: 5px; margin: 5px;">SS</div> - <div style="border: 1px dashed gray; padding: 5px; margin: 5px;">16</div> </div>
---	---

BSPT connections require the addition of a "B" prior to the inlet connection.

DIMENSIONS AND WEIGHTS

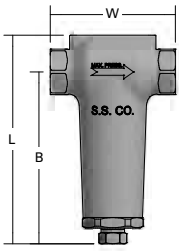
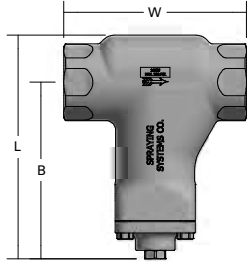
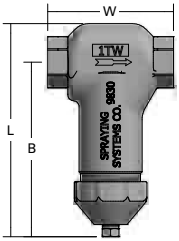
Strainer	Accessory Type	Inlet Conn. (in.)	L (in.)	W (in.)	B (in.)	Net Weight (oz.)
	TWD	1/4	3.922	2.500	3.235	24.9
		3/8	4.905	3.250	3.965	28.2
		1/2	4.905	3.250	3.965	28.2
		3/4	7.535	4.500	6.225	80.4
		1	7.535	4.500	6.225	76.7
		1-1/4	10.320	6.000	8.380	190.2
		1-1/2	10.320	6.000	8.380	183.5
		2	12.365	8.000	9.805	357.8
		2-1/2	12.365	8.000	9.805	334.1
	16106	1-1/2	9.0	7.250	7.240	188.9
		2	11.310	9.250	8.940	416.2
		2-1/2	11.310	9.250	8.940	392.9
	9830	3/4	8.180	5.250	7.187	140.6
		1	8.180	5.250	7.187	136.8

Based on the largest/heaviest version of each type.

DIMENSIONS AND WEIGHTS

Strainer	Accessory Type	Inlet Conn. (in.)	L (in.)	W (in.)	A (in.)	B (in.)	C (in.)	Net Weight (oz.)
	AA122	1/2	4.014	3.063	–	3.625	–	3.4
		3/4	4.014	3.063	–	3.625	–	3.2
	AA124	1-1/4	9.400	5.344	–	8.020	–	77.2
		1-1/2	9.400	5.344	–	8.020	–	76.9
		2	12.000	7.438	–	10.000	–	215.2
		2-1/2	12.000	7.438	–	10.000	–	204.9
	AA124SC	1-1/4	8.750	5.343	–	7.355	–	53.3
		1-1/2	8.750	5.343	–	7.355	–	52.2
	AA124ML	3/4	7.953	4.188	1	5.891	7.453	31.0
		1	7.953	4.188	1	5.891	7.453	30.3
		1-1/4	9.688	5.344	1.5	7.234	9.156	41.6
		1-1/2	9.688	5.344	1.5	7.234	9.156	39.2
		2	14.480	7.438	2.375	11.234	13.855	107.9
		2-1/2	14.480	7.375	2.375	11.234	13.855	103.0
	AA124ASC	3/4	8.325	4.188	–	7.170	–	52.5
		1	8.325	4.188	–	7.170	–	50.4

Based on the largest/heaviest version of each type.



DIMENSIONS AND WEIGHTS

Strainer	Accessory Type	Inlet Conn. (in.)	L (in.)	W (in.)	A (in.)	B (in.)	D (Dia.) (in.)	Net Weight (oz.)
	AA430ML	3/4	8.855	4.510	1.575	7.955	–	15.2
		1	8.855	4.510	1.575	7.955	–	14.1
		1-1/4	11.791	5.600	1.535	10.534	–	32.5
		1-1/2	11.791	5.600	1.535	10.534	–	33.2
	AA430MLSC	3/4	8.738	4.510	1.575	7.838	–	21.9
		1	8.738	4.510	1.575	7.838	–	21.2
		1-1/4	11.816	5.600	1.535	10.561	–	31.0
		1-1/2	11.816	5.600	1.535	10.561	–	31.7
	15925	3/4	11.660	3.750	–	10.650	–	212.5
		1	11.660	3.750	–	10.650	–	208.7
	8310A	1/4	6.090	2.750	–	5.340	–	76.9
		3/8	6.090	2.750	–	5.340	–	75.8
		1/2	6.090	2.750	–	5.340	–	74.8
	2820	1/4	5.438	–	–	–	1.875	51.0
		3/8	5.438	–	–	–	1.875	51.0
		1/2	5.438	–	–	–	1.875	50.2

Based on the largest/heaviest version of each type.

FILTRATION ASSEMBLY

- Filtration assemblies remove grit, scale and organic solids to help ensure nozzle performance and extend wear life – ideal for industrial and potable water
 - Removes slimy solids and algae from process water without premature loading
 - Extra solids holding capacity provides long service life and reduced maintenance
 - Low pressure drop and exceptional flow capacity
 - No tools required for disassembly or cleaning

39185 Filtration Assembly

3/4" female conn.
 Max. pressure: 125 psi (8.4 bar)
 Max. temperature of element: 190°F (88°C)
 Max. temperature of housing: 120°F (50°C)
 Materials: Clear styrene, acrylonitrile and polypropylene
 Filter sizes: 80, 130 and 300



Filter openings: .007" (18 mm) for 80; .005" (.13 mm) for 130; .002" (.05 mm) for 300.

MATERIAL

CODE

Polypropylene	PP
Polypropylene head/clear nylon bowl	NYC
Clear Styrene Acrylonitrile	SAN

AIR LINE FILTERS

- Air line filters protect equipment from corrosion and excessive wear by removing liquid and contaminants from air lines
 - Manual drain air line filter – simple petcock at the bottom of the bowl enables manual drainage; filter is easily accessible
 - Automatic drain air line filter – for use in inaccessible locations; a float-operated mechanism automatically expels liquid when over a critical level

11438 Air Line Filter

1/4", 3/8", 1/2", 3/4", 1" female conn.
 Manual or automatic drain
 50 micron filter element
 Max. pressure: 150 psi (10 bar)
 Max. temperature: 125°F (50°C)



Air Line Filter No.	Air Line Filter Type		Inlet Conn. (in.)	Approx. Flow at 100 psi*	
	Manual	Automatic		scfm	lpm
11438-1	•		1/4	50	1415
11438-2	•		3/8	50	1415
11438-3	•		1/2	150	4250
11438-4	•		3/4	345	9770
11438-5	•		1	445	12600
11438-16		•	1/4	50	1415
11438-17		•	1/2	150	4250
11438-19		•	1	445	12600

*With 5 psi pressure drop through filter.

11438-1, -2, -3, -16 and -17 have screw-on transparent polycarbonate bowls with bowl guards to prevent breakage. Not suitable for use in systems with air compressors lubricated with fire-resistant synthetics.



ORDERING INFORMATION

39185 FILTRATION ASSEMBLY

Filter Type	Inlet Conn.	Material Code	Filter Size	Example
				39185 - 3/4 - SAN - 130

11438 AIR LINE FILTER

Air Line Filter No.	Example
	11438-1

DIMENSIONS AND WEIGHTS

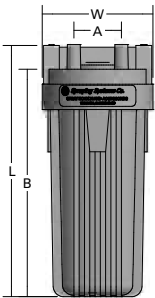
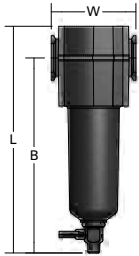
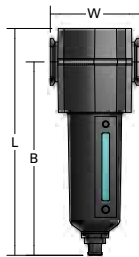
Filtration Assembly/Air Line Filter	Accessory Type	Inlet Conn. (in.)	L (in.)	W (in.)	A (in.)	B (in.)	Net Weight (oz.)
	39185	3/4	12.430	5.130	2.250	10.750	65.8
	11438-1	1/4	6.625	2.750	–	5.938	21.1
	11438-2	3/8	6.625	2.750	–	5.938	17.7
	11438-3	1/2	7.375	3.906	–	6.688	28.8
	11438-4	3/4	11.500	4.750	–	10.438	18.4
	11438-5	1	11.500	4.750	–	10.438	73.8
	11438-6	1-1/2	17.563	8.220	–	15.700	24
	11438-16	1/4	7.000	3.625	–	6.313	21.1
	11438-17	1/2	7.000	3.453	–	6.313	29.4
	11438-19	1	11.125	4.750	–	10.063	73.3

Based on the largest/heaviest version of each type.

OVERVIEW: QUICK-CONNECT NOZZLE SYSTEMS

- Save time cleaning and replacing spray nozzles with quick-connect nozzles. Nozzle bodies stay on header; spray tips are easily removed for cleaning and replacement
 - QuickJet® Nozzle System
 - Install and replace spray tips in seconds – quick-quarter turn is all that is needed
 - Automatic spray tip alignment
 - Integral seals eliminate leaks and stay in place during tip installation and removal
 - Choice of metal or chemically-resistant ProMax® material for use up to 150 psi (10 bar)
 - UniJet® Nozzle System
 - Fast spray tip removal and installation using wrench
 - Metal materials



QuickJet and UniJet nozzles are available in full cone, flat spray and hollow cone spray patterns. See those catalog sections for complete details.

QUICKJET ADAPTERS FOR UNIJET SPRAY TIPS

- QuickJet retaining caps allow easy use of UniJet nozzles
- Split-eyelet versions make connecting spray nozzles to piping systems quick and easy
 - Simply drill a hole in side of pipe
 - Place inlet of split eyelet into the hole; integral seal eliminates leaking
 - Assemble the clamp component to secure the assembly to the pipe
- Compatible with all UniJet spray tips



QUICK-CONNECT ADAPTER OPTIONS

QJ17560A-NYB

1/2", 3/4", 1", 20 mm,
25 mm pipe

Positive shut-off with
ChemSaver® check valve

Max. pressure: 300 psi
(20 bar)



QJ7421-NYB

1/2", 3/4", 1" pipe

Max. pressure: 300 psi
(20 bar)



QJ1/4TT-NYB

1/4" male conn.

Max. pressure: up to 300 psi
(20 bar)



QJ1/4T-NYB

1/4" female conn.

Max. pressure: up to 300 psi
(20 bar)



ORDERING INFORMATION

QUICKJET® ADAPTERS QJ17560 AND QJ7421

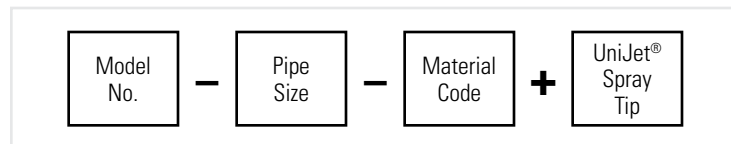

Example

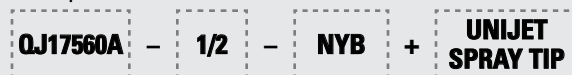

EPDM rubber diaphragm seal standard on QJ17560 and QJ7421. For Viton®, add VI after material code. Example: NYB-VI

QUICKJET ADAPTERS QJ1/4TT AND QJ1/4T

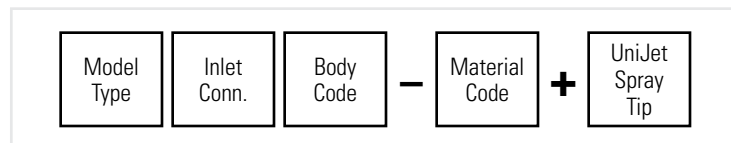

Example



*Additional cap required. See your sales engineer for alternative caps available. BSPT connections require the addition of a "B" prior to the inlet connection.

DIMENSIONS AND WEIGHTS

Adapter	Accessory Type	Inlet Conn. (in.)	Pipe Size (in.)	L (in.)	B (in.)	C (in.)	D (Dia.) (in.)	W (in.)	Hex. (in.)	Net Weight (oz.)
	QJ17560A-NYB	-	1/2	3.62	2.67	1.23	0.840	2	-	1.8
		-	3/4	3.64	2.93	1.23	1.050	2	-	1.8
		-	1	3.74	2.67	1.23	1.315	2.31	-	2
		-	20 mm	3.5	2.66	1.22	0.78	1.88	-	1.7
		-	25 mm	3.7	2.67	1.22	0.98	2	-	1.7
	QJ7421-1-NYB	-	1/2	2.41	1.61	-	0.840	1.67	-	0.9
		-	3/4	2.54	1.64	-	1.050	1.67	-	0.8
		-	1	2.75	1.77	-	1.315	2.54	-	1
	QJ1/4TT-NYB	1/4	-	1-19/32	-	-	0.95	-	3/4	0.3
	QJ1/4T-NYB	1/4	-	1-11/32	-	-	0.94	-	7/8	0.3

Based on the largest/heaviest version of each type.

**UNIJET DIAPHRAGM CHECK VALVE
NOZZLE BODIES**

- Diaphragm design minimizes pressure loss through check valve
- Max. pressure: 300 psi (20 bar)
- Stainless steel valve seat

**UNIJET DIAPHRAGM CHECK VALVE BODY
OPTIONS**

4664B

1/8" male conn.
Max. flow rate: 1.5 gpm (5.7 lpm)
Materials: Aluminum, brass



8360

1/4" male conn.
Max. flow: 2 gpm (7.6 lpm)
Stainless steel springs:
opening pressures of 2, 5, 8,
15, 20 or 30 psi (0.14, 0.35,
0.55, 1.03, 1.4 or 2.07 bar)
Material: Nylon



MATERIAL

CODE

Aluminum	AL
Brass	No code
Nylon	NYB

UNIJET SPLIT-EYELET BODIES

- Quick and easy way to mount UniJet spray nozzles on piping systems
 - Simply drill a hole in side of pipe
 - Place inlet of split eyelet into the hole; integral seal eliminates leaking
 - Assemble the clamp component to secure the assembly to the pipe
- Max. pressure: up to 250 psi (17 bar)
- Max. flow rate: 3 gpm (11.4 lpm)
- Body and clamp materials: Brass, stainless steel



7421

1/2", 3/4", 1" pipe size
13/16" to 7/8" (20 to 22 mm),
1 to 1-11/16" (25 to 27 mm) or
1-1/4" to 1-3/8" (32 to 35 mm)
tubing O.D.



MATERIAL

CODE

Brass	No code
303 stainless steel	SS

ORDERING INFORMATION

8360 UNIJET DIAPHRAGM CHECK VALVE NOZZLE BODY

Model No.	Inlet Conn.	Body Material Code	Diaphragm Material Code	Spring Opening Press. (psi)	
—					<p>Example</p> <p style="text-align: center;"> 8360 — 1/4 — NYB — VI — 20 </p>

Spring opening pressure is ordered in psi.

4664B UNIJET DIAPHRAGM CHECK VALVE NOZZLE BODY

Model No.	—	Material Code	
—			<p>Example</p> <p style="text-align: center;"> 4664B — AL </p>

7421 UNIJET SPLIT-EYELET NOZZLE BODY

NOZZLE BODY				SPRAY TIP			
Model No.	Pipe Size	Body Type	Material Code	+	UniJet Spray Tip		
—					+	<p>Example</p> <p style="text-align: center;"> 7421 — 1/2 T — SS + UNIJET SPRAY TIP </p>	

DIMENSIONS AND WEIGHTS

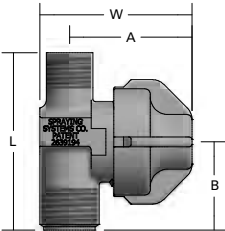
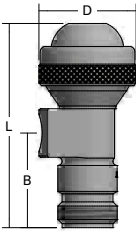
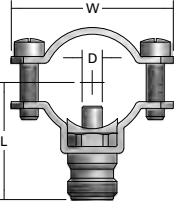
Body	Accessory Type	Inlet Conn. (in.)	Pipe Size (in.)	A (in.)	B (in.)	D (Dia.) (in.)	L (in.)	W (in.)	Net Weight (oz.)
	8360	1/4	—	1.42	1.02	—	2.05	1.76	0.7
	4664B	1/8	—	—	1.1	0.938	2.36	—	3.2
	7421	—	1/2	—	—	0.297	1.375	1.890	3.1
		—	3/4	—	—	0.297	1.625	2.125	2.2
		—	1	—	—	0.297	1.73	2.250	2.3

Based on the largest/heaviest version of each type.

UNIJET STRAINERS AND FILTER

- Use with most standard UniJet and Quick UniJet body assemblies
- In-line design for use at tip
- Low pressure loss
- Easy installation and removal
- Corrosion resistant versions
- Stainless steel mesh; other materials available upon request
- Pair most styles with CP4743 nylon gasket to prevent leaks

Note: Standard UniJet and Quick UniJet nozzles include a strainer. Mesh size is based on orifice diameter. Order strainers separately only if ordering replacement spray tip or if a special version is needed.

FILTER OPTION

9106 Filter

Effective filtration
 Higher filtration than other strainers;
 300 mesh equivalent
 Material: Fused bronze – durable
 and corrosion resistant



STRAINER OPTIONS

6051 303 stainless steel

5053 brass

8079 polypropylene

Mesh: 24, 50, 100 and 200



4193A

Built-in check valve
 Stainless steel springs: opening pressures of
 5, 10, 20 or 40 psi (0.35, 0.7, 1.5 or 2.8 bar)
 Materials: Aluminum, brass, polypropylene,
 303 stainless steel
 Mesh: 24, 50, 100, and 200



4514

One-piece design
 Slotted design accommodates larger
 particulates
 Materials: Brass or nylon with 16, 25
 or 50 mesh equivalents; aluminum with
 16 or 25 mesh equivalents



4067

Cup design for use when space is limited
 Material: 303 stainless steel
 Mesh: 30, 50, 100 and 200



7630

Disc design for use when space
 is extremely limited
 Material: 303 stainless steel
 Mesh: 30, 50, 100 and 200



MATERIAL

CODE

Aluminum	AL
Brass	No code
Nylon	NY
Polypropylene	PP
303 stainless steel	SS

ORDERING INFORMATION

UNIJET STRAINERS 5053, 6051 AND 8079

Strainer Type	-	Material Code	-	Mesh Size	Example 6051 - SS - 50
---------------	---	---------------	---	-----------	--

UNIJET STRAINER 4193A

Strainer Type	-	Material Code	-	Spring Opening Pressure (psi)	-	Mesh Size	Example 4193A - SS - 5 - 50SS
---------------	---	---------------	---	-------------------------------	---	-----------	--

Spring opening pressure is ordered in psi.

UNIJET STRAINER 4514

Strainer Type	-	Material Code	-	Slot Width	Example 4514 - NY - 10
---------------	---	---------------	---	------------	--

Use slot width 10 for 50 mesh equivalent; slot width 20 for 25 mesh equivalent and slot width 32 for 16 mesh equivalent.

UNIJET STRAINERS 4067 AND 7630

Strainer Type	-	Mesh Size	Example 4067 - 200
---------------	---	-----------	-------------------------------------

9106 FILTER

Filter Type	Example 9106
-------------	------------------------

DIMENSIONS AND WEIGHTS

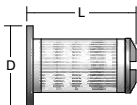
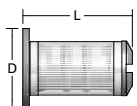
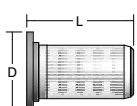
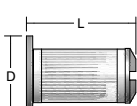
Strainer	Accessory Type	L (in.)	D (Dia.) (in.)	Net Weight (oz.)
	5053	0.81	0.594	1.76
	6051	0.81	0.594	0.03
	8079	0.80	0.594	0.03
	4193A	0.81	0.594	0.37

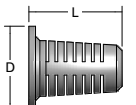
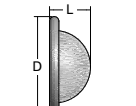
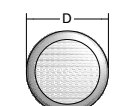
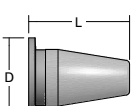
Strainer	Accessory Type	L (in.)	D (Dia.) (in.)	Net Weight (oz.)
	4514	0.66	0.594	0.19
	4067	0.24	0.594	0.19
	7630	0.06	0.594	0.02
	9106	0.75	0.594	0.22

11370 JET STABILIZER

- Install just before the spray nozzle to reduce fluid turbulence
- Helps reduce spray pattern flutter, increase fluid throw distance and increase impact force
- Ideal when nozzles are installed in 90° elbow forcing fluid to change direction
- For use with UniJet flat spray and hollow cone nozzles

11370 Jet Stabilizer

1/8" x 1/8", 1/4" x 1/4", 3/8" x 3/8", 1/2" x 1/2", 3/4" x 3/4", 1" x 1", 1-1/4" x 1-1/4"
 male inlet conn./female outlet conn.

Materials: Brass, stainless steel



11750 LARGE CAPACITY CHECK VALVE

- Use instead of 4193A for higher flow rates – up to 1.5 gpm (5.7 lpm)
- Prevents dripping from nozzles after line pressure is shut-off
- Compatible with all UniJet spray tips with capacities from 0.4 to 1.5 gpm (1.5 to 5.7 lpm)

11750 Large Capacity Check Valve

Opening pressure: 5 psi (.35 bar)*

Materials: Stainless steel ball and spring; aluminum, brass, polypropylene, stainless steel bodies



*Opening pressure: 10 and 20 psi (0.7 and 1.5 bar) available upon request

CP1325 TIP RETAINER

- Standard nozzle retaining cap for all UniJet style assemblies
- Standard UniJet nozzle and Quick UniJet nozzles include a tip retainer. Order CP1325 when replacement is needed

CP1325 Tip Retainer

Materials: Brass, stainless steel

For high pressure applications, use 7890 tip retainer



4916 METERING PLATE

- Fine-tune flow rate between available nozzle sizes
- Orifice slows fluid; conserves water and may extend wear life

4916 Metering Plate

82 orifice diameters from .008 to .25" (0.2 to 6.35 mm)*

Max. flow rate: 6.9 gpm (26 lpm)

Material: Stainless steel



*Request data sheets 11739, 12417 and 23471-2 for complete information.

UNIJET ADAPTERS

- 4676 Adapter – Use to go from a standard UniJet body to a 1/8", 1/4", 3/8" or 3/4" female outlet
- 6406 Adapter – Use to go from UniJet thread to 1/8" male inlet conn.

ADAPTER OPTIONS

4676 Adapter

11/16"-16 female inlet conn.
Materials: Brass, stainless steel



6406 Adapter

1/8" male outlet conn.
Materials: Aluminum, brass, stainless steel



MATERIAL

CODE

Aluminum	AL
Brass	No code
Nylon	NY
Polypropylene	PP
303 stainless steel	SS

ORDERING INFORMATION

11370 JET STABILIZER

Stabilizer Type	—	Material Code	—	Conn. Size	Example
					11370 — SS — 1/8 x 1/8

BSPT connections require the addition of a "B" prior to the inlet connection.

11750 LARGE CAPACITY UNIJET CHECK VALVE

Valve Type	—	Material Code	—	Opening Pressure (psi)	Example
					11750 — AL — 5

Opening pressure is ordered in psi.

CP1325 UNIJET TIP RETAINER

Model No.	—	Material Code	Example
			CP1325 — SS

4916 METERING PLATE

Model No.	—	Orifice Dia.	Example
			4916 — 78

4676 AND 6406 UNIJET ADAPTERS

Model No.	—	Material Code	Example
			4676 — SS

BSPT connections require the addition of a "B" prior to the inlet connection.

DIMENSIONS AND WEIGHTS

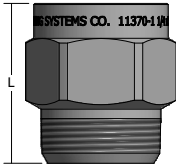
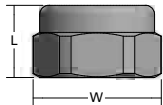
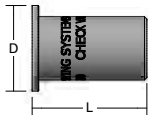
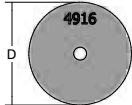
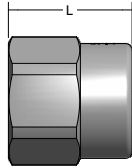
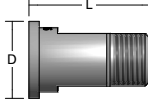
	Accessory Type	Inlet Conn. (in.)	Outlet Thread (in.)	L (in.)	W (in.)	Hex. (in.)	D (Dia.) (in.)	Net Weight (oz.)
	11370 jet stabilizer	–	–	2.219	–	1-7/8	–	36.02
	1325 UniJet tip retainer	–	–	0.500	0.890	13/16	–	0.66
	11750 check valve	–	–	0.797	–	–	0.594	0.36
	4916 metering plate	–	–	–	–	–	0.594	0.02
	4676 adapter	11/16–16	1/8	0.797	–	13/16	–	2.59
		11/16–16	1/4	0.859	–	13/16	–	2.77
		11/16–16	3/8	1.031	–	13/16	–	3.25
		11/16–16	1/2	1.109	–	1	–	5.38
		11/16–16	3/4	1.188	–	1-3/16	–	8.06
	6406 adapter	–	1/8	0.938	–	13/32 flats	0.594	0.64

QUICK UNIJET ADAPTER AND CAPS

- Easily retrofit standard UniJet bodies and GunJet® spray guns to Quick UniJet styles
- Color-coded Quick UniJet caps allows quick identification of nozzles by type or flow rate in same production line
- EPDM gaskets to ensure proper sealing with spray tip. Viton® also available
- Material: Celcon or nylon
- Max pressure: 300 psi (20 bar)

ADAPTER OPTION

QJT-NYB Adapter

Fits 11/16"-16 UniJet thread



COLOR-CODED CAP OPTIONS



All caps are available in all colors. Be sure to specify color code when ordering. Different tip types fit in different caps. See below.

CAP AND TIP COMPATIBILITY

Use with:

- UniJet small capacity flat spray tips, standard sizes through TPU_08
 - Celcon cap only: CP114440A
 - Celcon cap and seat gasket: 114441A
- UniJet large capacity flat spray tips, standard sizes TPU_10 through TPU_20
 - Nylon cap only: CP25609
 - Nylon cap and seat gasket: 25610
- UniJet flat spray tips, sizes through TPU_08. All tips to be positioned parallel or perpendicular to wings of Quick UniJet cap
 - Nylon cap only: CP25595
 - Nylon cap and seat gasket: 25596
- UniJet tips: TC, TG, TK, TN, TPU, T-W and TX
 - Celcon cap only: CP114444A
 - Celcon cap and seat gasket: 114445A
- UniJet tips: Disk and core
 - Celcon cap only: 114444A



ORDERING INFORMATION

QUICK UNIJET CAP AND SEAT GASKET SET

UniJet Cap and Seat Gasket Set	—	Color Code	—	Material Code	<p style="text-align: center;">Example</p> <div style="display: flex; justify-content: space-around; align-items: center;"> <div style="border: 1px dashed gray; padding: 5px;">114441A</div> <div>—</div> <div style="border: 1px dashed gray; padding: 5px;">3</div> <div>—</div> <div style="border: 1px dashed gray; padding: 5px;">CELR</div> </div>
--------------------------------	---	------------	---	---------------	--

Contact your sales engineer for dimensions and weights.

UniJet Cap and Seat Gasket Set	—	Color Code	—	Material Code	<p style="text-align: center;">Example</p> <div style="display: flex; justify-content: space-around; align-items: center;"> <div style="border: 1px dashed gray; padding: 5px;">25610</div> <div>—</div> <div style="border: 1px dashed gray; padding: 5px;">3</div> <div>—</div> <div style="border: 1px dashed gray; padding: 5px;">NYR</div> </div>
--------------------------------	---	------------	---	---------------	---

Contact your sales engineer for dimensions and weights.

QJ46761 cap and seat enables use of standard 1/8" and 1/4" nozzles. Request data sheet 20055 for complete information.

19843-NYR cap and seat provides shut-off at nozzle for quick spacing changes. For use with disc and core type tips. Black only.

QUICK UNIJET CAP ONLY

UniJet Cap	—	Color Code	—	Material Code	<p style="text-align: center;">Example</p> <div style="display: flex; justify-content: space-around; align-items: center;"> <div style="border: 1px dashed gray; padding: 5px;">CP114440A</div> <div>—</div> <div style="border: 1px dashed gray; padding: 5px;">3</div> <div>—</div> <div style="border: 1px dashed gray; padding: 5px;">CELR</div> </div>
------------	---	------------	---	---------------	--

UniJet Cap	—	Color Code	—	Material Code	<div style="display: flex; justify-content: space-around; align-items: center;"> <div style="border: 1px dashed gray; padding: 5px;">CP25609</div> <div>—</div> <div style="border: 1px dashed gray; padding: 5px;">3</div> <div>—</div> <div style="border: 1px dashed gray; padding: 5px;">NY</div> </div>
------------	---	------------	---	---------------	---

Contact your sales engineer for dimensions and weights.

QUICK UNIJET SEAT GASKET ONLY

Seat Gasket	—	Material Code	<p style="text-align: center;">Example</p> <div style="display: flex; justify-content: space-around; align-items: center;"> <div style="border: 1px dashed gray; padding: 5px;">CP19438</div> <div>—</div> <div style="border: 1px dashed gray; padding: 5px;">EPR</div> </div>
-------------	---	---------------	---

Contact your sales engineer for dimensions and weights.

Seat Gasket	—	Material Code	<p style="text-align: center;">Example</p> <div style="display: flex; justify-content: space-around; align-items: center;"> <div style="border: 1px dashed gray; padding: 5px;">CP19438</div> <div>—</div> <div style="border: 1px dashed gray; padding: 5px;">VI</div> </div>
-------------	---	---------------	--

For Viton® seal, use VI for material code.

Contact your sales engineer for dimensions and weights.

See Trademark Registration and Ownership, page i-1.

OVERVIEW: SPLIT-EYELET CONNECTORS AND ADJUSTABLE BALL FITTINGS

- Use split-eyelet connectors to provide a quick and easy way to connect spray nozzles to piping systems
 - Simply drill a hole in side of pipe
 - Place inlet of split eyelet into the hole; seal eliminates leaking
 - Assemble the clamp component to secure the assembly to the pipe
- Adjustable ball fitting enables precise control of spray direction. Assemble nozzle into the ball and adjust the orientation of the nozzle. Large internal passages minimize clogging



OPTIONS

7521

1/2", 3/4", 1" pipe size
1/8", 1/4" female outlet conn.



8370

1-1/4", 1-1/2", 2" pipe size
1/8", 1/4", 3/8", 1/2" female outlet conn.



15475

2-1/2", 3", 4" pipe size
1/4", 3/8", 1/2", 3/4", 1" female outlet conn.



36275 Adjustable Ball

1/8", 1/4", 3/8", 1/2", 3/4" male inlet conn.
1/8", 1/4", 3/8", 1/2", 3/4" male outlet conn.
45° total included angle of adjustment
Materials: Brass, 303 stainless steel, 316 stainless steel



MATERIAL

CODE

Zinc-plated steel clamps/bolts with brass body	A
All stainless steel	B
Zinc-plated steel clamps/bolts with stainless connector body	C
Stainless steel clamps/bolts with brass body	D

ORDERING INFORMATION

SPLIT-EYELET CONNECTOR

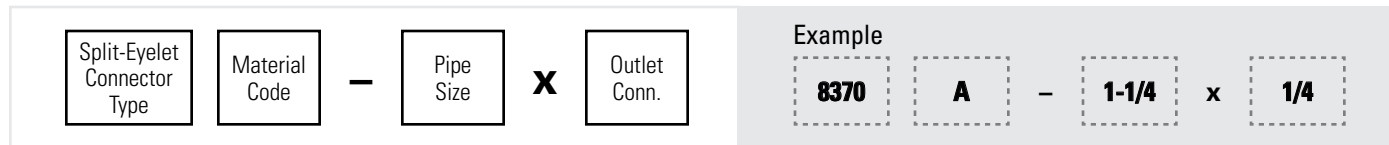

BSPT connections require the addition of a "B" prior to the connector type.

ADJUSTABLE BALL FITTING 36275



BSPT connections require the addition of a "B" prior to the inlet connection.

SPECIFICATIONS

Split-Eyelet	To Clamp On		Outlet Conn. (F) (in.)						Maximum Pressure psi	Capacity at Maximum Pressure gpm	Material Code
	Pipe Size (in.)	Outside Dia. Tubing (in.)	1/8	1/4	3/8	1/2	3/4	1			
7521	1/2	13/16, 7/8	•	•					250	3.5	A, B, C, D
	3/4	1, 1-1/16	•	•							
	1	1-1/8, 1-1/4, 1-3/8	•	•							
8370	1-1/4	1-9/16, 1-11/16	•	•	•	•			125	5.5-20*	A, B, C
	1-1/2	1-3/4, 2	•	•	•	•					
	2	2-1/8, 2-3/8	•	•	•	•					
15475	2-1/2	2-1/2, 2-7/8		•	•	•	•	•	125	10-54*	A, B, C
	3	3, 3-1/2		•	•	•	•	•			
	4	4, 4-1/2		•	•	•	•	•			

Capacities of 8370 and 15475 Vary with Outlet Conn.	
Outlet Conn. (in.)	Capacity gpm
1/8	5.5
1/4	10
3/8	15
1/2	20
3/4	33
1	54

*Capacities of 8370 and 15475 vary with outlet connection.

Adjustable Ball Fitting	Inlet Conn. (in.)	Outlet Conn. (in.)	Materials
36275	1/8	1/8	Brass (no code), 303 stainless steel (SS), 316 stainless steel (316SS)
	1/4	1/4	
	1/4	1/8	
	3/8	3/8	
	3/8	1/4	

If inlet and outlet connections are different sizes, contact your local sales engineer.

Adjustable Ball Fitting	Inlet Conn. (in.)	Outlet Conn. (in.)	Materials
36275	1/2	1/2	Brass (no code), 303 stainless steel (SS), 316 stainless steel (316SS)
	1/2	1/4	
	1/2	3/8	
	3/4	3/4	

If inlet and outlet connections are different sizes, contact your local sales engineer.

DIMENSIONS AND WEIGHTS

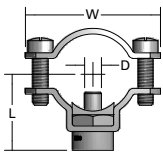
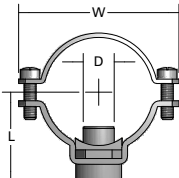
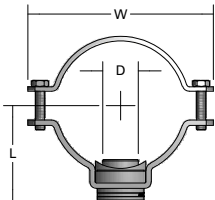
Split-Eyelet	Accessory Type	Pipe Size (in.)	W (in.)	D (Dia.) (in.)	L (in.)	Net Weight (oz.)
	7521	1/2	0.938	0.281	1.108	3.1
		3/4	0.938	0.281	1.213	3
		1	0.938	0.281	1.346	2.3
	8370	1-1/4	1.063	0.688	1.611	6.3
		1-1/2	1.063	0.688	1.731	7
		2	1.063	0.688	1.970	7.4
	15475	2-1/2	1.125	1.250	2.469	9.8
		3	1.125	1.250	2.781	28.9
		4	1.125	1.250	3.281	34.2

Based on the largest/heaviest version of each type.

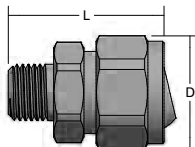
Adjustable Ball	Accessory Type	Inlet Conn. (in.)	Outlet Conn. (in.)	L (in.)	D (Dia.) (in.)	Hex. (in.)	Net Weight (oz.)
	36275	1/8	1/8	1.375	0.969	7/8	2
		1/4	1/4	1.563	1.094	1	3
		1/4	1/8	1.563	1.094	1	3.1
		3/8	3/8	1.781	1.375	1-1/4	5.5
		3/8	1/4	1.375	1.004	1-1/4	5.8
		1/2	1/2	2.219	1.656	1-1/2	10
		1/2	1/4	1.875	1.375	1-1/2	5.8
		1/2	3/8	1.875	1.375	1-1/2	5.4
		3/4	3/4	2.406	1.906	1-7/8	17

Based on the largest/heaviest version of each type.



OVERVIEW: CHECK VALVES

- Positive drip-free shut-off maintains line pressure during on/off spraying cycles
- Minimal pressure drop through CV and diaphragm valves

CHECK VALVE OPTIONS

AB Ball

1/8", 1/4" male inlet and female outlet conn.
 Max. pressure: 125 psi (9 bar)
 Max. flow rate: 2 gpm (8 lpm)
 5, 10 or 20 psi (0.35, 0.7 or 1.5 bar) opening pressures
 Materials: Aluminum, brass, stainless steel



BB Ball

1/4" male inlet and male outlet conn.
 Max. pressure: up to 125 psi (9 bar)
 Max. flow rate: 0.5 gpm (2 lpm)
 5, 10, 20 or 25 psi (0.35, 0.7, 1.5 or 1.7 bar) opening pressures
 Materials: Brass, stainless steel



10742A Diaphragm

1/8", 1/4" male inlet and female outlet conn.
 Max. flow rate: 2 gpm (8 lpm)
 7 psi (0.5 bar) opening pressure
 Materials: Aluminum, brass



12328 Diaphragm

1/2", 3/4" male inlet and female outlet conn.
 Max. flow rate: 15 gpm (57 lpm)
 7 psi (0.5 bar) opening pressure
 Material: Nylon



CV Series

AACV 1/8", 1/4" female inlet and female outlet conn.
 BACV 1/8", 1/4" male inlet and female outlet conn.
 ABCV 1/8", 1/4" female inlet and male outlet conn.
 BBCV 1/8", 1/4" male inlet and male outlet conn.
 Max. pressure: 150 psi (10 bar)
 5, 10 or 20 psi (0.35, 0.7 or 1.5 bar) opening pressures
 Materials: Brass, stainless steel



MATERIAL

CODE

Aluminum	AL
Brass	No code
Nylon	NYB
303 stainless steel	SS

ORDERING INFORMATION

AB AND BB BALL-TYPE CHECK VALVES

Inlet/ Outlet Conn.	Check Valve Type	—	Material Code	Opening Pressure (psi)	Example					
					<table border="1"> <tr> <td>1/8</td> <td>AB</td> <td>—</td> <td>SS</td> <td>20</td> </tr> </table>	1/8	AB	—	SS	20
1/8	AB	—	SS	20						

BSPT connections require the addition of a "B" prior to the inlet connection. Opening pressure is ordered in psi.

10742A DIAPHRAGM CHECK VALVE

Check Valve Type	—	Inlet/ Outlet Conn.	—	Material Code	Example					
					<table border="1"> <tr> <td>10742A</td> <td>—</td> <td>1/8</td> <td>—</td> <td>AL</td> </tr> </table>	10742A	—	1/8	—	AL
10742A	—	1/8	—	AL						

BSPT connections require the addition of a "B" prior to the inlet connection.

12328 DIAPHRAGM CHECK VALVE

Check Valve Type	—	Inlet/ Outlet Conn.	—	Material Code	Example					
					<table border="1"> <tr> <td>12328</td> <td>—</td> <td>1/2</td> <td>—</td> <td>NYB</td> </tr> </table>	12328	—	1/2	—	NYB
12328	—	1/2	—	NYB						

BSPT connections require the addition of a "B" prior to the inlet connection.

CV SERIES CHECK VALVE

Inlet/ Outlet Conn.	Check Valve Type	—	Material Code	Opening Pressure (psi)	Example					
					<table border="1"> <tr> <td>1/4</td> <td>ABCV</td> <td>—</td> <td>SS</td> <td>5</td> </tr> </table>	1/4	ABCV	—	SS	5
1/4	ABCV	—	SS	5						

BSPT connections require the addition of a "B" prior to the inlet connection. Opening pressure is ordered in psi.



DIMENSIONS AND WEIGHTS

Check Valve	Accessory Type	Inlet Conn. (in.)	Outlet Conn. (in.)	A (in.)	B (in.)	L (in.)	D (Dia.) (in.)	W (in.)	Hex. (in.)	Net Weight (oz.)
	AB	1/8 (M)	1/8 (F)	–	–	1.813	–	–	5/8	2
		1/4 (M)	1/4 (F)	–	–	2.313	–	–	13/16	3.33
	BB	1/4 (M)	1/4 (M)	–	–	0.954	0.609 dia.	–	9/16	1.10
	10742A	1/8 (M)	1/8 (F)	1.412	0.906	1.422	–	1.07	0.688 sq.	3.73
		1/4 (M)	1/4 (F)	1.412	0.953	1.469	–	1.07	0.688 sq.	3.73
	12328	1/2 (M)	1/2 (F)	1.624	1.219	3.343	–	3.063	–	25.75
		3/4 (M)	3/4 (F)	1.624	1.219	3.343	–	3.063	–	25.75
	AACV	1/8 (F)	1/8 (F)	–	–	2.340	–	–	13/16	3.25
		1/4 (F)	1/4 (F)	–	–	2.340	–	–	13/16	3.54
	BACV	1/8 (M)	1/8 (F)	–	–	2.280	–	–	13/16	3.25
		1/4 (M)	1/4 (F)	–	–	2.340	–	–	13/16	3.54
	ABCV	1/8 (F)	1/8 (M)	–	–	2.680	–	–	13.16	3.25
		1/4 (F)	1/4 (M)	–	–	2.340	–	–	13/16	3.69
	BBCV	1/8 (M)	1/8 (M)	–	–	2.620	–	–	13/16	3.72
		1/4 (M)	1/4 (M)	–	–	2.340	–	–	13/16	3.70

Based on the largest/heaviest version of each type.

OVERVIEW: PLUG AND BALL VALVES

- Easy in-line shut-off
- Manual operation
- Ball valve provides more robust operation than plug valves
- Max. pressure: 400 psi (27 bar)

PLUG VALVE OPTIONS

23220 Plug Valve, Female x Female

Available in:

- 1/8" female inlet and 1/8" female outlet conn.
- 1/4" female inlet and 1/8" female outlet conn.
- 1/4" female inlet and 1/4" female outlet conn.

Materials: Brass body with Celcon® plug handle



23220 Plug Valve, Female x T Outlet

Available in:

- 1/4" female inlet and T outlet conn.
- 1/4" female inlet conn. and 11/16"-16 UniJet® thread outlet

Materials: Brass body with Celcon plug handle



23220 Plug Valve, Male x T Outlet

Available in:

- 1/4" male inlet and T outlet conn.
- 1/4" male inlet conn. and 11/16"-16 UniJet thread outlet

Materials: Brass body with Celcon plug handle



23220 Plug Valve, Male x Female

Available in:

- 1/4" male inlet and 1/4" female outlet conn.

Materials: Brass body with Celcon plug handle



23220 Plug Valve, Female x Male

Available in:

- 1/4" female inlet and 1/4" male outlet conn.

Materials: Brass body with Celcon plug handle



BALL VALVE OPTIONS

20900 Ball Valve

On/off ball type

UniJet system compatible

1/4" male or female inlet and 11/16"-16 UniJet thread outlet

Materials: Brass body and handle; stainless steel ball



ORDERING INFORMATION

PLUG VALVES



BSPT connections require the addition of a "B" prior to the inlet connection.

DIMENSIONS AND WEIGHTS

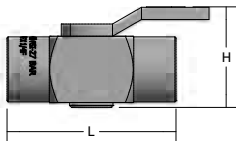
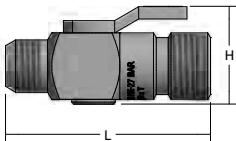
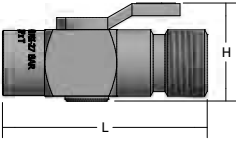
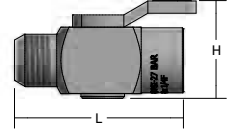
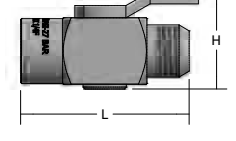
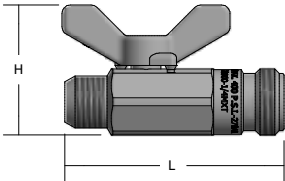
Valve	Accessory Type	Inlet Conn. (in.)	Outlet Conn. (in.)	L (in.)	H (in.)	Net Weight (oz.)
	23220	1/4 (F)	1/8 (F)	1-3/4	1-5/32	2.08
		1/4 (F)	1/4 (F)	1-3/4	1-5/32	2.08
		1/8 (F)	1/8 (F)	1-3/4	1-5/32	2.43
	23220	1/4 (M)	11/16-16	2-1/8	1-5/32	2.25
	23220	1/4 (F)	11/16-16	2-1/8	1-5/32	2.29
	23220	1/4 (M)	1/4 (F)	1-3/4	1-5/32	2.08
	23220	1/4 (F)	1/4 (M)	1-3/4	1-5/32	1.98
	20900	1/4 (M)	11/16-16	2-5/16	1-5/16	3.06
		1/4 (F)	11/16-16	2-5/16	1-5/16	3.24

Based on the largest/heaviest version of each type.



OVERVIEW: THROTTLING AND PRESSURE RELIEF/REGULATING VALVES

- Easily regulate flow in systems using centrifugal pumps with throttling valves; adjustable cap and lock ring provide easy valve control
- Control line pressure and minimize liquid waste with adjustable relief valves that return excess liquid back to the liquid source or pump inlet

PRESSURE RELIEF REGULATING VALVE OPTIONS

23120

1/2", 3/4" male inlet and female outlet conn.

Pressure relief valve

Adjustable lock nut

Material: Polypropylene



8460

1/2", 3/4" male inlet and female bypass conn.

Diaphragm-style pressure relief valve

Female pressure gauge port and plug for use when pressure gauge not used

Fairprene® diaphragm seal prevents fluid from working parts

Materials: Aluminum housing with nylon body



6815

1/2", 3/4" male inlet and female outlet conn.

Piston-type pressure relief valve

Free floating design improves speed and sensitivity

Materials: Aluminum, brass, hardened stainless steel



110

1", 1-1/4", 1-1/2" conn.

Piston-type pressure relief valve

Guide vane seat stabilizes flow for vibration reduction

Free floating design improves speed and sensitivity

Removable valve bonnet: no disturbance of fluid line connections

Materials: Aluminum, brass, ductile iron, hardened stainless steel



THROTTLING VALVE OPTION

23520

1/2", 3/4" male inlet and female outlet conn.

Throttling valve

Material: Polypropylene



MATERIAL

CODE

Aluminum	AL
Brass	No code
Ductile Iron	No code
Hardened stainless steel	HSS
Nylon/Aluminum	NY
Polypropylene	PP

See Trademark Registration and Ownership, page i-1.

ORDERING INFORMATION

PRESSURE RELIEF/REGULATING VALVE



BSPT connections require the addition of a "B" prior to the inlet connection. Pressure rating is ordered in psi.

THROTTLING VALVE

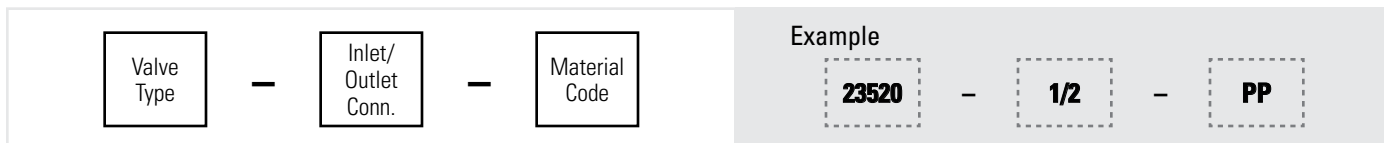

BSPT connections require the addition of a "B" prior to the inlet connection.

SPECIFICATIONS

Inlet/Outlet Pipe Conn. (in.)	Operating Pressure Max. psi (bar)	Valve Type							
		23520	23120	8460	6815	6815-HSS	6815-AL	110	110-AL
1/4	Up to 300 (20)							•	
	300 to 700 (20 to 48)							•	
	700 to 1000 (48 to 70)							•	
3/8	Up to 300 (20)							•	
	300 to 700 (20 to 48)							•	
	700 to 1000 (48 to 70)							•	
1/2	Up to 50 (3.5)				•		•		
	Up to 150 (10.4)	•	•						
	Up to 300 (20)			•	•		•		
	300 to 700 (20 to 48)				•		•		
	700 to 1200 (48 to 85)				•	•			
3/4	Up to 50 (3.5)				•		•		
	Up to 150 (10.4)	•	•						
	Up to 300 (20)			•	•		•		
	300 to 700 (20 to 48)				•		•		
	700 to 1200 (48 to 85)				•	•			
1	Up to 150 (10)								•
1-1/4	Up to 150 (10)								•
1-1/2	Up to 150 (10)								•

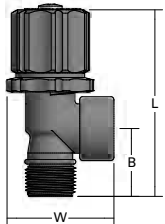
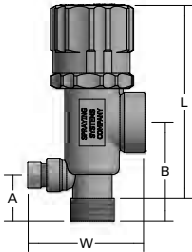
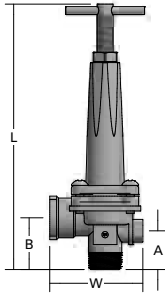
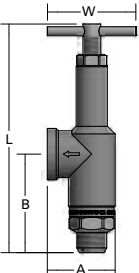
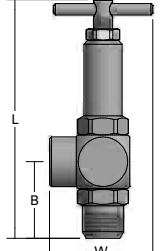

DIMENSIONS AND WEIGHTS

Valve	Accessory Type	Inlet/Outlet Conn. (in.)	L at Max. Opening Height (in.)	A (in.)	B (in.)	W (in.)	Net Weight (oz.)
	23520	1/2	4	–	1.175	2	2.9
		3/4	4.5	–	1.409	2.25	2.9
	23120	1/2	5.25	1.063	2.375	2.63	5.65
		3/4	5.25	1.063	2.375	2.69	5.75
	8460	1/2	8	1.218	1.624	2.813	14.8
		3/4	8	1.218	1.624	2.813	14.5
	6815	1/2	6.625	1.191	2.750	2.5	20
		3/4	6.625	1.191	2.750	2.5	20
	110	1/4	4	–	1.219	1.69	7.1
		3/8	4	–	1.219	1.69	7.1
		1	7.25	–	2.515	2.69	43.4
		1-1/4	7.5	–	2.610	2.75	49.8
		1-1/2	7.75	–	4.210	2.968	56

Based on the largest/heaviest version of each type.

SOLENOID VALVES

- On/off flow control in automatically operated systems
- Dependable performance in air and liquid lines with temperatures from 40° to 165°F (5° to 75°C)
- Ten watt, class “F” coils are for continuous duty; UL and CSA approved; suitable for international use
- Encapsulated coil resists high humidity and fungus growth
- 360° rotation available with durable electrostatically powder-coated enclosure
- Stainless steel pilot orifice helps eliminate premature leaking and increases service life in high flow velocity situations
- Floating plungers automatically compensate for vibration, shock, wear and deformation while providing a bubble-tight seal
- Versatile mounting in any position; direct pipe mounting

SOLENOID VALVE OPTIONS

2-Way

1/4", 3/8", 1/2", 3/4", 1" conn.

Direct-acting poppet or pilot-operated diaphragm valve action

Materials: Brass, stainless steel



3-Way

1/4", 3/8", 1/2" conn.

Poppet or diaphragm valve action

Materials: Brass, stainless steel



ORDERING INFORMATION

COMPLETE SOLENOID VALVE*

<div style="border: 1px solid black; padding: 5px; width: fit-content; margin: 0 auto;"> Model No. </div>	Example <div style="border: 1px dashed black; padding: 5px; width: fit-content; margin: 0 auto;"> 11438-20 </div>
---	--

BSPT connections require the addition of a “B” prior to the inlet connection.

*110 or 120 V, 50/60 Hz coil is standard. If other coil assemblies are desired, add the appropriate letter code to the end of the part number. For example: 11438-20A.

A = 220 or 240 V, 50/60 Hz

B = 24 V, 60 Hz

C = 12 VDC

D = 24 VDC



SPECIFICATIONS

Port Conn. (in.)	Valve Action	Valve Type	Model Number	Max. Pressure (psi)	Orifice Size (in.)	Cv Factor**	Body Material	Seal Material
1/4	Direct Acting Poppet	2-way	11438-20	60*	3/16	.50	Stainless steel	Viton®
1/4	Direct Acting Poppet	2-way	11438-21	205*	1/8	.28	Stainless steel	Kel-F®
3/8	Pilot-Operated Diaph.	2-way	11438-22	150*	7/16	2.5	Forged or cast brass	Buna-N
1/2	Pilot-Operated Diaph.	2-way	11438-23	150*	5/8	4.0	Forged or cast brass	Buna-N
3/4	Pilot-Operated Diaph.	2-way	11438-24	230	3/4	7.8	Forged or cast brass	Buna-N
1	Pilot-Operated Diaph.	2-way	11438-25	230	1	13.0	Forged or cast brass	Buna-N
1/4	Poppet	3-way	11438-30	100	3/32	.25/.38	Forged or cast brass	Viton
1/2	Diaph.	3-way	11438-31	150	1/2	3.6	Forged or cast brass	Buna-N
3/8	Diaph.	3-way	11438-32	150	7/16	1.6/2.5	Aluminum	Buna-N

*For maximum pressures of coils "C" and "D", request Data Sheet 11438 – Solenoid (1).

**For use of Cv Factor, request Data Sheet 11438 – Solenoid (2).

See Trademark Registration and Ownership, page i-1.

DIMENSIONS AND WEIGHTS

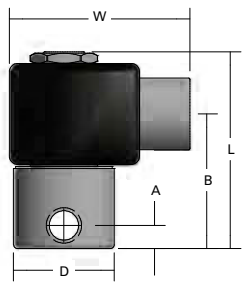
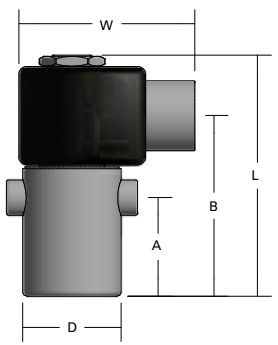
Solenoid Valve	Accessory Type	A (in.)	B (in.)	D (Dia.) (in.)	L (in.)	W (in.)	Net Weight (oz.)
	11438-20	0.344	1.938	1.625	2.906	2.76	20.3
	11438-21	0.344	1.938	1.625	2.906	2.76	20.3
	11438-22	0.594	2.594	1.969	3.563	2.76	19.9
	11438-23	0.531	3.406	2.656	4.406	2.76	35.9
	11438-24	0.875	3.719	3.938	4.750	2.76	61
	11438-25	0.875	3.719	3.938	4.750	2.76	34.4
	11438-30	1.125	2.750	1.563	3.750	2.76	21.3
	11438-31	1.063	3.156	3.094	5.625	2.76	25.3
	11438-32	1.500	3.750	1.375	4.375	2.76	12.4

Based on the largest/heaviest version of each type.



LIQUID AND AIR PRESSURE REGULATORS

- Diaphragm-type non-relieving liquid pressure regulators
 - Operating temperature range: 35° to 200°F (2° to 93°C)
 - Gauges supplied separately
- Diaphragm-type, relieving and non-relieving style air pressure regulators
 - Relieving style automatically relieves excessive air pressure in a regulated line; non-relieving types also available
 - Regulated line pressure can be reduced with adjusting knob even when line is dead ended
 - Operating temperature range: 0° to 175°F (-15° to +80°C) with dew point less than air temperatures below 35°F (2°C)
 - Gauges supplied separately

REGULATOR OPTIONS

11438 Air Pressure Regulator

Diaphragm, relieving and non-relieving types
 Regulated pressures from 5 to 125 psi (0.3 to 8.5 bar) with supply line pressures up to 300 psi (20 bar)
 Materials: Die cast aluminum, stainless steel, zinc



11438 Liquid Pressure Regulator

Non-relieving type
 Regulated pressures from 5 to 125 psi (0.3 to 8.5 bar) with primary supply line pressures
 Max. pressure: 400 psi (28 bar)
 Materials: Brass, brass-plated zinc or stainless steel



ORDERING INFORMATION

AIR PRESSURE REGULATOR

Regulator No.	Example 11438-45
---------------	----------------------------

LIQUID PRESSURE REGULATOR

Regulator No.	Example 11438-250
---------------	-----------------------------

SPECIFICATIONS

Regulator Type	Regulator Style	Regulator Number	Max. Pressure (psi)	Main Ports (in.)	Gauge Ports (in.)	Material
Air	Non-relieving	11438-35	300	1/4	1/4	Zinc
		11438-36	300	3/8	1/4	Zinc
		11438-37	300	1/2	1/4	Zinc
		11438-38	300	3/4	1/4	Aluminum
		11438-39	300	1	1/4	Aluminum
	Relieving	11438-45	300	1/4	1/4	Zinc
		11438-45S	300	1/4	1/8	316 stainless steel
		11438-46	300	3/8	1/4	Zinc
		11438-47	300	1/2	1/4	Zinc
		11438-47S	300	1/2	1/4	316 stainless steel
11438-48		300	3/4	1/4	Aluminum	
Liquid	Diaphragm	11438-250	400	1/4	1/4	Brass
		11438-251	400	3/8	1/4	Brass
		11438-252	400	1/2	1/4	Brass
		11438-253	400	3/4	1/8	Brass
		11438-254	400	1	1/8	Brass

Stainless steel versions meet NACE standard MR-01-75 for corrosion resistance

DIMENSIONS AND WEIGHTS

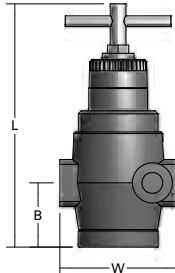
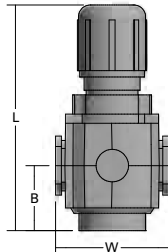
Regulator	Accessory Type 11438-	B (in.)	L (in.)	W (in.)	Net Weight (oz.)
	250, 251	1.500	5.750	2.750	42.7
	252	1.594	5.938	3.313	47.6
	253, 254	1.625	9.500	5.000	129.1
	35, 36, 45, 46	1.438	5.125	2.750	21.6
	37, 47	1.500	5.875	3.500	30.5
	38, 39, 48, 49	2.375	6.875	4.250	54.3
	45S	0.375	2.750	1.500	5.5
	47S	1.625	7.813	3.500	7.2

Based on the largest/heaviest version of each type.



LIQUID PRESSURE GAUGES

- Easy-to-read gauges with bottom inlet connection or center back connection
- Patented spring-suspended movement protected by a corrosion- and impact-resistant ABS housing with polycarbonate window
- Dual scales: psi and bar
- Grade B accuracy within $\pm 2\%$ in the middle 50% of the scale, with 3% accuracy in the high and low ends of the scale
- 0 psi to a maximum of 300 psi (0 bar to a maximum of 20 bar)
- Materials: All wetted parts are brass; combination brass/bronze connection; bourdon tube

GAUGE OPTIONS

26383

1/8", 1/4" center back male conn.
2" (51 mm) dia. housing



26385

1/4" bottom male conn.
2-1/2" (64 mm) dia. housing



ORDERING INFORMATION

PRESSURE GAUGE 26383



Pressure rating is ordered in psi.

PRESSURE GAUGE 26385

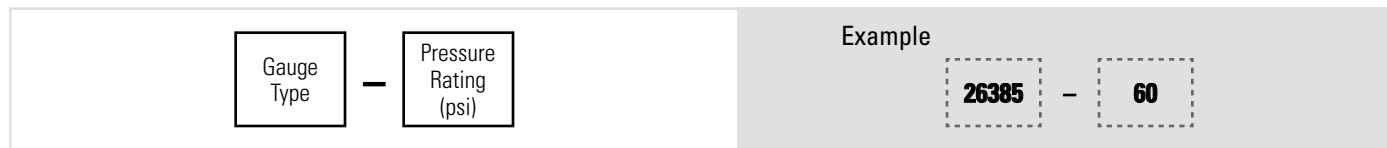

Pressure rating is ordered in psi.

SPECIFICATIONS

Gauge Type	Inlet Conn. (M)	Pressure Rating psi (bar)	Pressure Range psi (bar)
26383	1/8, 1/4	60 (4)	0 - 60 (0 - 4)
	1/8, 1/4	100 (7)	0 - 100 (0 - 7)
	1/8, 1/4	160 (11)	0 - 160 (0 - 11)

Gauge Type	Inlet Conn. (M)	Pressure Rating psi (bar)	Optimum Operating Range psi (bar)
26385	1/4	60 (4)	15 - 45 (1.0 - 3.1)
	1/4	100 (7)	25 - 75 (1.7 - 5.2)
	1/4	160 (11)	40 - 120 (2.8 - 8.3)
	1/4	300 (21)	75 - 225 (5.2 - 15.5)

OVERVIEW: HOSES AND MOUNTING BASES

- Bendable hoses stay in place once they are positioned
 - Works with a variety of nozzle types
 - Lengths: 6", 12", 18", 24", 30" and 36" (15, 30, 46, 61, 76 and 91 cm)
 - Max. pressure: 250 psi (17.5 bar)
 - Max. operating temperature: air – 250°F (121°C); liquid – 200°F (93°C)
 - Max. operating flow at 250 psi (17.5 bar): 33 scfm (934 Nlpm)
- Magnetic mounting bases provide fast, easy set-up of nozzles
 - Shut-off valve assembled on base



STAY-N-PLACE HOSE OPTIONS

57020

1/4" male x 1/4" female conn.



57025

1/4" male x 1/4" male conn.



MAGNETIC MOUNTING BASE OPTIONS

57045

Single or double outlet



ORDERING INFORMATION

STAY-N-PLACE HOSES

<div style="border: 1px solid black; padding: 5px; display: inline-block;">Model No.</div> - <div style="border: 1px solid black; padding: 5px; display: inline-block;">Hose Length</div>	<p>Example</p> <div style="border: 1px dashed gray; padding: 5px; display: inline-block; margin-right: 10px;">57020</div> - <div style="border: 1px dashed gray; padding: 5px; display: inline-block;">6</div>
---	---

BSPT connections require the addition of a "B" prior to the model number. Example: B57020
Hoses are ordered in inch lengths.

MAGNETIC MOUNTING BASE

<div style="border: 1px solid black; padding: 5px; display: inline-block;">Base No.</div> - <div style="border: 1px solid black; padding: 5px; display: inline-block;">Outlet Number</div>	<p>Example</p> <div style="border: 1px dashed gray; padding: 5px; display: inline-block; margin-right: 10px;">57045</div> - <div style="border: 1px dashed gray; padding: 5px; display: inline-block;">001</div>
--	---

Use 001 for single outlet; 002 for double outlet
BSPT connections require the addition of a "B". Example: B57045

DIMENSIONS AND WEIGHTS

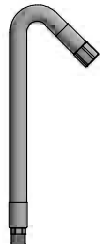
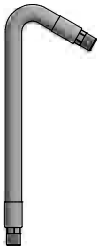
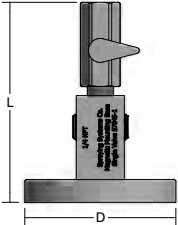
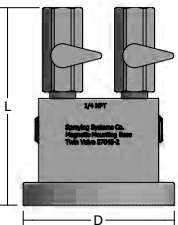
Hose, Base	Accessory Type	Hose Length (in.)	Inlet Conn. (in.)	L (in.)	D (Dia.) (in.)	Net Weight (oz.)
	57020	6	1/4	-	0.69	0.3
		12	1/4	-	0.69	0.5
		18	1/4	-	0.69	0.7
		24	1/4	-	0.69	0.9
		30	1/4	-	0.69	1.0
		36	1/4	-	0.69	1.2
	57025	6	1/4	-	0.69	0.3
		12	1/4	-	0.69	0.5
		18	1/4	-	0.69	0.7
		24	1/4	-	0.69	0.9
		30	1/4	-	0.69	1.0
		36	1/4	-	0.69	1.2
	57045-1	-	1/4	2.220	3.15	27.20
	57045-2	-	1/4	2.220	3.15	27.20

Based on the largest/heaviest version of each type.

**SPRAYING SYSTEMS CO.'S
TRADEMARK USAGE**

The following is a current list of Spraying Systems Co.'s trademarks registered in the United States. Some marks are registered in other countries as well.

- | | |
|--------------|------------|
| AccuCoat® | SpiralJet® |
| AutoJet® | SprayDry® |
| ChemSaver® | SprayWare® |
| DeflectoJet® | TankJet® |
| DistriboJet® | UniJet® |
| FlatJet® | VeeJet® |
| FloodJet® | WashJet® |
| FogJet® | WhirlJet® |
| FullJet® | WindJet® |
| GunJet® | |
| IMEG® | |
| iSpray® | |
| MiniFogger® | |
| PanelSpray® | |
| ProMax® | |
| QuickJet® | |

REGISTERED TRADEMARK CREDITS

The following trademarks are registered to other entities in the US and may be registered in other countries as well.

- AMPCO®
- ANSI®
- ASME®
- ASTM®
- Carpenter®
- Celcon®
- Cupro®
- Fairprene®
- Hastelloy®
- Iconel®
- Kel-F®
- Kynar®
- Monel®
- NACE® International
- Norgren®
- Parker®
- Refrax®
- Stellite®
- Viton®

Spraying Systems Co. reserves the right to make changes in specifications or design of the products shown in the catalog or to add improvements at anytime without notice or obligation.



(1) MODIFICATION OF TERMS

Seller's acceptance of any order is expressly subject to Buyer's assent to each and all of the terms and conditions set forth below and Buyer's assent to these terms and conditions shall be conclusively presumed from Buyer's receipt of this document without prompt written objection thereto or from Buyer's acceptance of all or any part of goods ordered. No addition to or modification of said terms and conditions shall be binding upon Seller unless specifically agreed to by Seller in writing. If Buyer's purchase order or other correspondence contains terms or conditions contrary to or in addition to the terms and conditions set forth below, acceptance of any order by Seller shall not be construed as assent to such contrary or additional terms and conditions or constitute a waiver by Seller of any of the terms and conditions.

(2) PRICE

Unless otherwise specified: (a) all prices, quotations, shipments and deliveries by Seller are (i) EXW (Incoterms® 2010) if shipped to the Buyer within the United States, and (2) in all other circumstances DAP Buyer's location (Incoterms® 2010); (b) all base prices together with related extras and deductions, are subject to Seller's price in effect at the time of shipment; and (c) notwithstanding the use of the shipping term DAP and without any effect on the point at which the risk of loss shifts from Seller to Buyer, all transportation, import costs and other related charges are for the account of Buyer, including all increases or decreases in such charges prior to shipment. Payment of said price shall be due at the remittance address shown on the Seller's invoice upon receipt of Seller's invoice unless otherwise specified. Interest will be charged at a rate of 1 to 1-1/2% per month on all balances outstanding more than 30 days after the date of the invoice. Price includes Seller's standard packaging. Special packaging requirements shall be quoted at an additional price.

(3) UNIFORM COMMERCIAL CODE

THIS IS A CONTRACT FOR THE SALE OF GOODS. SELLER AND BUYER EXPRESSLY AGREE THAT ANY SERVICES PROVIDED PURSUANT TO THIS CONTRACT ARE MERELY INCIDENTAL TO THE SALE OF GOODS, AND AS SUCH, SHALL BE DEEMED GOODS UNDER ARTICLE 2 OF THE UNIFORM COMMERCIAL CODE. SELLER AND BUYER FURTHER AGREE THAT ANY DISPUTES ARISING FROM THIS CONTRACT SHALL BE GOVERNED BY ARTICLE 2 OF THE UNIFORM COMMERCIAL CODE.

(4) MINIMUM BILLING

Contact your regional office representative for any minimum order requirements.

(5) WARRANTIES

Seller warrants that its products will conform to and perform in accordance with the products' specifications. Seller warrants that the products do not infringe upon any copyright, patent, or trademark. THE FOREGOING WARRANTIES ARE IN LIEU OF ALL OTHER WARRANTIES, EXPRESSED OR IMPLIED, INCLUDING, BUT NOT LIMITED TO, THOSE CONCERNING MERCHANTABILITY AND FITNESS FOR A PARTICULAR PURPOSE.

(6) LIMITATION OF REMEDIES

Buyer's remedies under this warranty shall be limited to the replacement, repair, or refund of the purchase price for any defective product at the Seller's option. Products claimed to be defective and for which repair or replacement is desired shall be, if requested by the Seller, returned transportation prepaid to Seller's plant for inspection. Results of ordinary wear and tear, improper operation, or maintenance or use of corrosive or abrasive materials shall not be considered a defect in material or workmanship. Any component part manufactured by another is not covered by Seller's warranty, but only by such warranty as its manufacturer gives. Because of the difficulty of asserting and measuring damages hereunder, it is agreed that, except for claims for bodily injury, Seller's liability to the Buyer or any third party, for any losses or damages, whether direct or otherwise, arising out of the purchase of product from Seller by Buyer shall not exceed the total amount billed and billable to the Buyer for the product hereunder. IN NO EVENT WILL SELLER BE LIABLE FOR ANY LOSS OF PROFITS OR OTHER SPECIAL OR CONSEQUENTIAL DAMAGES, EVEN IF SELLER HAS BEEN ADVISED OF THE POSSIBILITY OF SUCH DAMAGES.

(7) QUALITY ASSURANCE

Seller shall have no obligation to ensure that any goods purchased from Seller meet any special Buyer quality assurance specifications and/or other special Buyer requirements unless such specifications and/or other requirements are specifically set forth in Buyer's purchase order and expressly accepted by Seller. In the event that any such goods supplied by Seller in connection therewith, are applied to an end use without the appropriate specification and/or other requirement therefore having been set forth in Buyer's purchase order and expressly accepted by Seller, Buyer shall indemnify and hold Seller harmless against any and all damages or claims for damages made by any person for any injury, fatal or nonfatal, to any person or for any damage to the property of any person incident to or arising out of such application.

(8) PRODUCT DISPOSAL & SUSTAINABILITY

Buyer is responsible for the disposal of goods supplied by seller in accordance with all applicable laws, regulations, and responsible recycling and/or sustainability practices.

(9) CLAIMS

Claims respecting the condition of goods, compliance with specifications or any other matter affecting goods shipped to Buyer must be made promptly and, unless otherwise agreed to in writing by Seller, in no event later than one (1) year after receipt of the goods by Buyer. In no event shall any goods be returned, reworked or scrapped by Buyer without the express written authorization of Seller.

(10) DEFAULT IN PAYMENT

If Buyer fails to make payments on any contract between Buyer and Seller in accordance with Seller's terms, Seller, in addition to any other remedies available to it, may at its option, (i) defer further shipments until such payments are made and satisfactory credit arrangements are reestablished or (ii) cancel the unshipped balance of any order.

(11) TECHNICAL ASSISTANCE

Unless otherwise expressly stated by Seller, (a) any technical advice provided by Seller with respect to the use of goods furnished to Buyer shall be without charge; (b) Buyer shall have sole responsibility for selection and specification of the goods appropriate for the end use of such goods.

(12) SAFETY PRECAUTIONS

Buyer shall require its employees to use all safety devices, and proper safe operation procedures as set forth in manuals and instruction sheets furnished by Seller. Buyer shall not remove or modify any such device or warning sign. It is the Buyer's responsibility to provide all means that may be necessary to effectively protect all employees from serious bodily injury which otherwise may result from the method of particular use, operation, set up or service of the goods. The operator's or machine manual, ANSI safety standards, OSHA regulations and other sources should be consulted. If Buyer fails to comply with provisions of this paragraph or the applicable standards and regulations aforementioned, and a person is injured as a result thereof, Buyer agrees to indemnify and save Seller harmless from any liability or obligation incurred by Seller.

(13) CANCELLATION

Orders for goods specifically manufactured for Buyer cannot be canceled or modified by Buyer, and releases cannot be held up by Buyer, after such goods are in process except with the express written consent of Seller and subject to conditions then to be agreed upon which shall include, without limitation, protection of Seller against all loss.

(14) PATENTS

The Seller shall not be liable for any costs or damages incurred by the Buyer as a result of any suit or proceeding brought against Buyer so far as based on claims (a) that use of any product, or any part thereof furnished hereunder, in combination with products not supplied by the Seller or (b) that a manufacturing or other process utilizing any product, or any part thereof furnished hereunder, constitute knowing and willful infringement of patents or trademarks arising from compliance with Buyer's designs or specifications or instructions.

(15) COMPLETE AGREEMENT

THIS CONTRACT SETS FORTH THE ENTIRE AGREEMENT AND UNDERSTANDING OF THE PARTIES RELATING TO THE SUBJECT MATTER HEREOF, AND SUPERSEDES ALL PRIOR AGREEMENTS, DISCUSSIONS AND UNDERSTANDINGS BETWEEN THEM WHETHER ORAL OR WRITTEN, RELATING TO THE SUBJECT MATTER HEREOF.

(16) GOVERNING LAW

All orders are accepted by Seller at its mailing address in Wheaton, Illinois, and shall be governed by and interpreted in accordance with the laws of the State of Illinois. The United Nations Convention on Contracts for the International Sale of Goods of April 11, 1980 shall be excluded.

(17) FORCE MAJEURE

Neither party shall be in default of its obligations to the other party for any period of Force Majeure. "Force Majeure" shall mean any delay or failure of a party to perform its obligations to the other party due to causes beyond its control and without its fault or negligence. This shall include, without limitation, Acts of God, strike, civil commotion, acts of government, and any other comparable, non-foreseeable, and a serious event.

(18) CONFIDENTIAL INFORMATION

Buyer shall maintain Confidential Information in confidence using the same care as used for its own Confidential Information. Buyer shall not disclose or divulge any Confidential Information received by it from Seller in connection with any products or services supplied by Seller to Buyer or to a third party without prior written consent of Seller, and Buyer may not use any Confidential Information for any purpose other than for the manufacture, sale and maintenance of Buyer's products. For the purposes hereof, "Confidential Information" includes any and all information and data, including, but not limited to, any business, commercial, intellectual property, technical information and data disclosed by Seller to Buyer in connection with the sale of Seller's products to Buyer, or relating to Seller's business relationship or the definition, development, marketing, selling, manufacture or distribution of Seller's products, whether disclosed orally, in writing or electronically, and irrespective of the medium in which such information or data is embedded, whether in tangible form or contained in an intangible storage medium. Confidential Information shall include any copies or abstracts made thereof, as well as any product, apparatus, modules, samples, prototypes or parts thereof.

(19) FAIR PRACTICES

Spraying Systems Co. considers for employment and hire qualified candidates without regard to race, religion, color, sex, sexual orientation, gender, gender identity, age, national origin, ancestry, citizenship, protected veteran or disability status or any factor prohibited by law, and as such affirms in policy and practice to support and promote the concept of equal employment opportunity and affirmative action, in accordance with all applicable federal, state, provincial and municipal laws.

In each product section, you'll find ordering examples. Start by reviewing the example and then create the part number by indicating the inlet connection, material and capacity size.

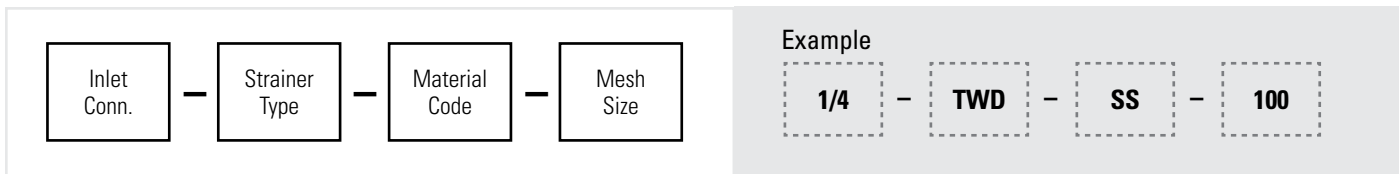
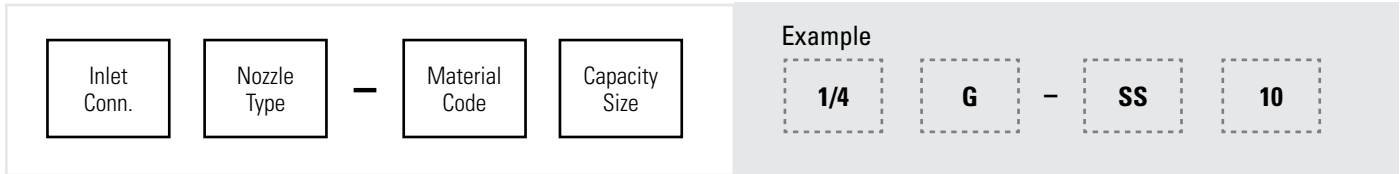

For your convenience, there are multiple ways to place an order: phone, fax and online

In North America

Phone: 1.800.95.SPRAY | Fax: 1.888.95.SPRAY

Outside North America

Phone: 1.630.665.5000 | Fax: 1.630.260.0842

Online ordering with a credit card is also available. Visit spray.com/ispray. You'll find helpful selection tools and a Live Chat option for immediate assistance.

FINDING PRODUCTS

- Consult the Product Index on **page i-4** if you know the name of the product
- Consult the Part Number Index on **page i-8** if you have the part number. Part numbers are shown numerically and alphanumerically
- If you're not sure what you need, our Selection Guidelines on **pages 10-11** will help you identify products typically used in dozens of applications

Selection assistance is also available by calling **1.800.95.SPRAY**. Representatives in your local sales office will help you determine which products best meet your application requirements. (Call **1.630.665.5000** outside North America or visit spray.com to find information for the sales office in your area.)



ADJUSTABLE BALL FITTINGS

36275 F23 – F25

AIR LINE FILTERS

11438 air line filter F10, F11

AIR PRESSURE REGULATORS

11438 regulators F36, F37

BALL VALVES

20900 F29, F30

CHECK VALVES

10742A diaphragms F26, F28

12328 diaphragms F26, F28

AB F26, F28

BB F26, F28

CV series

AACV F26, F28

ABCV F26, F28

BACV F26, F28

BBCV F26, F28

UniJet®

11750 large capacity F18, F20

4664B diaphragm body F14, F15

8360 diaphragm body F14, F15

DISTRIBOJET® NOZZLES

R B27 – B29

RF B27 – B29

RR B27 – B29

FILTRATION ASSEMBLY

39185 F10, F11

FLATJET® NOZZLES

P C47 – C49

FLOODJET® NOZZLES

Wide Angle Spray

K C40, C43 – C44, C46

TEK C40, C43 – C44, C46

See also: Quick FloodJet® Nozzles; UniJet® Nozzles

FOGJET® NOZZLES

Narrow Angle Spray

FF E8 – E9, E11 – E12

Wide Angle Spray

7G E8 – E10, E12

7N E8 – E9, E12

FULLJET® NOZZLES

D-HH B5 – B6, B9, B13

G B4, B6 – B7, B12

GA B4, B6 – B7, B12

GD B4, B6 – B7, B12

GG B4, B6 – B7, B12

GGA B4, B6 – B7, B12

GGD B4, B6 – B7, B12

H B5 – B9, B13

HD B5 – B8, B13

HF B5 – B6, B8 – B9, B13

HH B5 – B7, B13

Maximum Free Passage (MFP)

HHMFP B20 – B23

HMF B20 – B23

Narrow Angle Spray

G-15 B4, B6, B11 – B12

G-30 B4, B6, B11 – B12

GG-15 B4, B6, B11 – B12

GG-30 B4, B6, B11 – B12

H-15 B5 – B6, B11, B13

HH-30 B5 – B6, B11, B13

Oval Spray Pattern

G-VL B31 – B32, B34 – B35

GG-VL B31 – B32, B34 – B35

Square Spray Pattern

G-SQ B30, B32, B35

GG-SQ B30, B32, B35

H-SQ B30, B32 – B33, B35

HH-SQ B30, B32, B35

Vaneless Design

GANV B31 – B32, B34 – B35

GGANV B31 – B32, B34 – B35

Wide Angle Spray

G-W B4, B6, B10, B12

GA-W B4, B6, B10, B12

GG-W B4, B6, B10, B12

GGA-W B4, B6, B10, B12

H-W B5 – B6, B10, B13

HH-W B5 – B6, B10, B13

Wide Angle Square Spray Pattern

H-WSQ B30, B32 – B33, B35

HH-WSQ B30, B32 – B33, B35

See also: ProMax® Quick FullJet Nozzles; Quick FullJet® Nozzles

HIGH PRESSURE NOZZLES

UniJet® Body

11430 C38 – C39, D20 – D21, D26

UniJet® Spray Tips

EG C38 – C39

TN-SSTC D20 – D21, D25 – D26

See also: Ultra-High Pressure Nozzles

HOSES, STAY-N-PLACE

57020 F39, F40

57025 F39, F40



HYDRAULIC ATOMIZING FINE SPRAY NOZZLES

LN E4 – E7
 LND E4 – E7
 LNN E4 – E7
 LNND E4 – E7
 M E4 – E7
 N E4 – E7
 NN E4 – E7

Wide Angle Spray

LN-W E4 – E5, E7
 LNN-W E4 – E5, E7
 N-W E4 – E5, E7
 NN-W E4 – E5, E7

JET STABILIZER

11370 F18, F20

LIQUID PRESSURE REGULATORS

11438 regulators F36, F37

LIQUID PRESSURE GAUGES

26383 F38
 26385 F38

METERING PLATE

4916 F18, F20

MOUNTING BASES, MAGNETIC

57045 F39, F40

PLUG VALVES

23220 F29, F30

PRESSURE RELIEF VALVES

110 F31 – F33
 23120 F31 – F33
 6815 F31 – F33
 8460 F31 – F33

PROMAX® QUICK FULLJET NOZZLES

Body

QPPA B15 – B16, B19

Spray Tip

QPHA B15 – B17, B19

Wide Angle Spray Tip

QPHA-W B15 – B16, B18 – B19

PROMAX® QUICK VEEJET NOZZLES

Bodies

QPPA C15 – C16, C23
 QPPM miniature C15 – C16, C23

Spray Tips

QMVV miniature C15 – C21, C23
 QPTA C15 – C21, C23

QUICK-CONNECT NOZZLE SYSTEM OPTIONS

Adapters

QJ1/4T F12, F13
 QJ1/4TT F12, F13
 QJ17560A F12, F13
 QJ7421 F12, F13

Quick UniJet® Adapter

QJT adapter F21

Quick UniJet® Caps

CP25595 F21
 CP25607 F21
 CP25609 F21
 CP25611 F21

Quick UniJet® Caps and Seat Gasket

25596 F21
 25608 F21
 25610 F21
 25612 F21

UniJet®

11370 jet stabilizer F18, F20
 11750 large capacity check valve F18, F20
 4676 adapter F19, F20
 4916 metering plate F18, F20
 6406 adapter F19, F20
 CP1325 tip retainer F18, F20

UniJet® Bodies

4664B diaphragm F14, F15
 7421 split-eyelet F14, F15
 8360 diaphragm F14, F15

UniJet® Strainers and Filter

4067 F16, F17
 4193A F16, F17
 4514 F16, F17
 5053 F16, F17
 6051 F16, F17
 7630 F16, F17
 8079 F16, F17
 9106 filter F16, F17

QUICK FLOODJET® NOZZLES

Bodies

QJA C41, C43, C46
 QJJA C41, C43, C46
 QJJS miniature C41, C43, C46

Wide Angle Spray Tips

QSTK miniature C41, C43, C45 – C46
 QTKA C41, C43, C45 – C46



QUICK FULLJET® NOZZLES

Bodies

QJA B14, B16, B19
 QJJA B14, B16, B19
 QJJLA B14, B16, B19
 QJLA B14, B16, B19
 QPPA ProMax® B15 – B16, B19

Narrow Angle Spray Tips

QGA-15 B14, B16, B18 – B19
 QGA-30 B14, B16, B18 – B19
 QLGA-15 B14, B16, B18 – B19
 QLGA-30 B14, B16, B18 – B19

Spray Tips

QGA B14, B16 – B17, B19
 QHA B14, B16 – B17, B19
 QLGA B14, B16 – B17, B19
 QLHA B14, B16 – B17, B19
 QPHA ProMax® B15 – B17, B19

Wide Angle Spray Tips

QGA-W B14, B16, B18 – B19
 QHA-W B14, B16, B18 – B19
 QLGA-W B14, B16, B18 – B19
 QLHA-W B14, B16, B18 – B19
 QPHA-W ProMax® B15 – B16, B18 – B19

QUICK VEEJET® NOZZLES

Bodies

QJA C14, C16, C23
 QJJA C14, C16, C23
 QJJLA C14, C16, C23
 QJLA C14, C16, C23
 QJJS miniature C14, C16, C23
 QPPA ProMax® C15 – C16, C23
 QPPM ProMax® miniature C15 – C16, C23

Spray Tips

QLUA C14, C16 – C23
 QMVV ProMax® miniature C15 – C21, C23
 QPTA ProMax® C15 – C21, C23
 QSVV miniature C14, C16 – C19, C23
 QUA C14, C16 – C23
 QVVA C14, C16 – C23

SOLENOID VALVES

2-way F34, F35
 3-way F34, F35

SPIRALJET® NOZZLES

BSJ D18 – D19
 HHSJ B24 – B26
 HHSJX B24 – B26

SPLIT-EYELET

7421 UniJet® body F14, F15

Connectors

15475 F23 – F25
 7521 F23 – F25
 8370 F23 – F25

STRAINERS

2820 in-line F5, F9

T-Style, Liquid

15925 F5, F9
 16106 F4, F7
 8310A F5, F9
 9830 F4, F7
 AA122 F4, F8
 AA124 F5, F8
 AA124ASC F5, F8
 AA124ML F5, F8
 AA124SC F5, F8
 AA430ML F5, F9
 AA430MLSC F5, F9
 TWD F4, F7

UniJet®

4067 F16, F17
 4193A F16, F17
 4514 F16, F17
 5053 F16, F17
 6051 F16, F17
 7630 F16, F17
 8079 F16, F17
 9106 filter F16, F17

THROTTLING VALVE

23520 F31 – F33

TIP RETAINER

CP1325 F18, F20

ULTRA-HIGH PRESSURE NOZZLES

VS625 C50 – C52, C54
 VS940 C50 – C52, C54

Ultra-High Pressure Bodies

58833 C50 – C51, C54
 58834 C50 – C51, C54

Ultra-High Pressure Spray Tips

FS013 C50 – C51, C53 – C54
 FS020 C50 – C51, C53 – C54
 VS010 C50 – C52, C54
 VS020 C50 – C51, C53 – C54
 VS051 C50 – C51, C53 – C54



UNIJET® NOZZLES

Bodies

11430 high pressure C38 – C39, D20 – D21, D26
 T B36 – B37, B40, C24 – C25, C31,
 C42 – C43, C46, D20 – D21, D26
 TT B36 – B37, B40, C24 – C25, C31,
 C42 – C43, C46, D20 – D21, D26

Spray Tips

13802 C24 – C31
 D B36 – B38, B40, D20 – D21, D23 – D24, D26
 EG high pressure C38 – C39
 TG B36 – B37, B39 – B40
 TN D20 – D21, D25 – D26
 TN-SSTC high pressure D20 – D21, D25 – D26
 TPU C24 – C31
 TX D20 – D22, D26

Square Pattern Spray Tip

TG-SQ B36 – B37, B40

Wide Angle Spray Tips

TG-W B36 – B37, B39 – B40
 TH-W B36 – B37, B39 – B40
 TK FloodJet® C42 – C43, C45 – C46
 T-W D20 – D22, D26

See also: FloodJet® Nozzles; Quick FloodJet® Nozzles

VEEJET® NOZZLES

H-DT C4 – C8, C13
 H-DU C4 – C5, C9 – C13
 H-U C4 – C5, C9 – C13
 H-VV C4 – C8, C13
 H-VVL C4 – C8, C13
 U C4 – C5, C9 – C13

See also: ProMax® Quick VeeJet Nozzles; Quick VeeJet® Nozzles

WASHJET® NOZZLES

IMEG® C32, C34, C36 – C37
 MEG C32, C34 – C35, C37
 MEG-SSTC C32, C34 – C35, C37
 WEG C32, C34 – C35, C37

Quick-Connect

QCIMEG C33 – C34, C37
 QCMEG C33 – C34, C36 – C37

WHIRLJET® NOZZLES

AP D5 – D6, D11 – D12, D16
 AX D4, D6 – D7, D15
 BX D4, D6 – D7, D15
 CF D4, D6, D10, D16
 CRC D4, D6, D10, D16
 CX D4, D6, D9, D15
 D D4, D6, D11, D16
 LAP D5 – D6, D11 – D12, D17
 LBP D5 – D6, D11 – D12, D17

Deflected Wide Angle Spray Nozzle

8686 D27 – D28, D31 – D32

In-Line Nozzles

BD D27 – D29, D32
 BDM D27 – D28, D30, D32

In-Line Wide Angle Spray Nozzle

BD-W D27 – D28, D30, D32

Offset-Type Nozzle

BA D27 – D28, D31 – D32

Wide Angle Spray

AP-W D5 – D6, D13, D16
 AX-W D4, D6, D8, D15
 BX-W D4, D6, D8, D15
 E D5 – D6, D14 – D15, D17
 LAP-W D5 – D6, D14, D17
 LBP-W D5 – D6, D14, D17



NUMERIC

1
 10742A F26, F28
 110 F31 – F33
 11370 F18, F20
 11430 C38 – C39, D20 – D21, D26
 11438-1-19 F10, F11
 11438-20-32 F34, F35
 11438-35-49 F36, F37
 11438-250-254 F36, F37
 11750 F18, F20
 12328 F26, F28
 13802 C24 – C31
 15475 F23 – F25
 15925 F5, F9
 16106 F4, F7

2
 20900 F29, F30
 23120 F31 – F33
 23220 F29, F30
 23520 F31 – F33
 25596 F21
 25608 F21
 25610 F21
 25612 F21
 26383 F38
 26385 F38
 2820 F5, F9

3
 36275 F23 – F25
 39185 F10, F11

4
 4067 F16, F17
 4193A F16, F17
 4514 F16, F17
 4664B F14, F15
 4676 F19, F20
 4916 F18, F20

5
 5053 F16, F17
 57020 F39, F40
 57025 F39, F40
 57045 F39, F40
 58833 C50 – C51, C54
 58834 C50 – C51, C54

6
 6051 F16, F17
 6406 F19, F20
 6815 F31 – F33

7
 7421 F14, F15
 7521 F23 – F25
 7630 F16, F17
 7G E8 – E10, E12
 7N E8 – E9, E12

8
 8079 F16, F17
 8310A F5, F9
 8360 F14, F15
 8370 F23 – F25
 8460 F31 – F33
 8686 D27 – D28, D31 – D32

9
 9106 F16, F17
 9830 F4, F7

ALPHABETICAL

A
 AA122 F4, F8
 AA124 F5, F8
 AA124SC F5, F8
 AA124ML F5, F8
 AA124ASC F5, F8
 AA430ML F5, F9
 AA430SC F5, F9
 AACV F26, F28
 AB F26, F28
 ABCV F26, F28
 AP D5 – D6, D11 – D12, D16
 AP-W D5 – D6, D13, D16
 AX D4, D6 – D7, D15
 AX-W D4, D6, D8, D15

B
 BA D27 – D28, D31 – D32
 BACV F26, F28
 BB F26, F28
 BBCV F26, F28
 BD D27 – D29, D32
 BD-W D27 – D28, D30, D32
 BDM D27 – D28, D30, D32
 BSJ D18 – D19
 BX D4, D6 – D7, D15
 BX-W D4, D6, D8, D15

C
 CF D4, D6, D10, D16
 CP1325 F18, F20
 CP25595 F21
 CP25607 F21
 CP25609 F21
 CP25611 F21
 CRC D4, D6, D10, D16
 CX D4, D6, D9, D15

D
 D B36 – B38, B40, D4, D6,
 D11, D16, D20 – D21,
 D23 – D24, D26
 D-HH B5 – B6, B9, B13

E
 E D5 – D6, D14 – D15, D17
 EG C38 – C39

F
 FF E8 – E9, E11 – E12
 FS013 C50 – C51, C53 – C54
 FS020 C50 – C51, C53 – C54



G

G B4, B6 – B7, B12
 G-15 B4, B6, B11 – B12
 G-30 B4, B6, B11 – B12
 G-SQ B30, B32, B35
 G-VL B31 – B32, B34 – B35
 G-W B4, B6, B10, B12
 GA B4, B6 – B7, B12
 GA-W B4, B6, B10, B12
 GANV B31 – B32, B34 – B35
 GD B4, B6 – B7, B12
 GG B4, B6 – B7, B12
 GG-15 B4, B6, B11 – B12
 GG-30 B4, B6, B11 – B12
 GG-SQ B30, B32, B35
 GG-VL B31 – B32, B34 – B35
 GG-W B4, B6, B10, B12
 GGA B4, B6 – B7, B12
 GGA-W B4, B6, B10, B12
 GGANV B31 – B32, B34 – B35
 GGD B4, B6 – B7, B12

H

H B5 – B9, B13
 H-15 B5 – B6, B11, B13
 H-DT C4 – C8, C13
 H-DU C4 – C5, C9 – C13
 H-SQ B30, B32 – B33, B35
 H-U C4 – C5, C9 – C13
 H-VV C4 – C8, C13
 H-VVL C4 – C8, C13
 H-W B5 – B6, B10, B13
 H-WSQ B30, B32 – B33, B35
 HD B5 – B8, B13
 HF B5 – B6, B8 – B9, B13
 HH B5 – B7, B13
 HH-30 B5 – B6, B11, B13
 HH-SQ B30, B32, B35
 HH-W B5 – B6, B10, B13
 HH-WSQ B30, B32 – B33, B35
 HHMFP B20 – B23
 HHSJ B24 – B26
 HHSJX B24 – B26
 HMFP B20 – B23

I

IMEG® C32, C34, C36 – C37

K

K C40, C43 – C44, C46

L

LAP D5 – D6, D11 – D12, D17
 LAP-W D5 – D6, D14, D17

LBP D5 – D6, D11 – D12, D17
 LBP-W D5 – D6, D14, D17
 LN E4 – E7
 LN-W E4 – E5, E7
 LND E4 – E7
 LNN E4 – E7
 LNN-W E4 – E5, E7
 LNND E4 – E7

M

M E4 – E7
 MEG C32, C34 – C35, C37
 MEG-SSTC C32, C34 – C35, C37

N

N E4 – E7
 N-W E4 – E5, E7
 NN E4 – E7
 NN-W E4 – E5, E7

P

P C47 – C49

Q

QCIMEG C33 – C34, C37
 QCMEG C33 – C34, C36 – C37
 QGA B14, B16 – B17, B19
 QGA-15 B14, B16, B18 – B19
 QGA-30 B14, B16, B18 – B19
 QGA-W B14, B16, B18 – B19
 QHA B14, B16 – B17, B19
 QHA-W B14, B16, B18 – B19
 QJ1/4T F12, F13
 QJ1/4TT F12, F13
 QJ17560A F12, F13
 QJ7421 F12, F13
 QJA B14, B16, B19, C14,
 C16, C23, C41, C43, C46
 QJJA B14, B16, B19, C14,
 C16, C23, C41, C43, C46
 QJJS C14, C16, C23, C41,
 C43, C46
 QJJLA B14, B16, B19, C14,
 C16, C23
 QJLA B14, B16, B19, C14,
 C16, C23
 QJT F21
 QLGA B14, B16 – B17, B19
 QLGA-15 B14, B16, B18 – B19
 QLGA-30 B14, B16, B18 – B19
 QLGA-W B14, B16, B18 – B19
 QLHA B14, B16 – B17, B19
 QLHA-W B14, B16, B18 – B19
 QLUA C14, C16 – C23

QMVV C15 – C21, C23
 QPHA B15 – B17, B19
 QPHA-W B15 – B16, B18 – B19
 QPPA B15 – B16, B19,
 C15 – C16, C23
 QPPM C15 – C16, C23
 QPTA C15 – C21, C23
 QSTK C41, C43, C45 – C46
 QSVV C14, C16 – C19, C23
 QTKA C41, C43, C45 – C46
 QUA C14, C16 – C23
 QVVA C14, C16 – C23

R

R B27 – B29
 RF B27 – B29
 RR B27 – B29

T

T B36 – B37, B40, C24 – C25,
 C31, C42 – C43, C46,
 D20 – D21, D26
 T-W D20 – D22, D26
 TT B36 – B37, B40, C24 – C25,
 C31, C42 – C43, C46,
 D20 – D21, D26
 TEK C40, C43 – C44, C46
 TG B36 – B37, B39 – B40
 TG-SQ B36 – B37, B40
 TG-W B36 – B37, B39 – B40
 TH-W B36 – B37, B39 – B40
 TK C42 – C43, C45 – C46
 TN D20 – D21, D25 – D26
 TN-SSTC D20 – D21, D25 – D26
 TPU C24 – C31
 TWD F4, F7
 TX D20 – D22, D26

U

U C4 – C5, C9 – C13

V

VS010 C50 – C52, C54
 VS020 C50 – C51, C53 – C54
 VS051 C50 – C51, C53 – C54
 VS625 C50 – C52, C54
 VS940 C50 – C52, C54

W

WEG C32, C34 – C35, C37





Spraying Systems Co.[®]
Experts in Spray Technology

North Avenue and Schmale Road, P.O. Box 7900, Wheaton, IL 60187-7901 USA

Tel: 1.800.95.SPRAY Intl. Tel: 1.630.665.5000

Fax: 1.888.95.SPRAY Intl. Fax: 1.630.260.0842

Email: info@spray.com

www.spray.com



Catalog 75D HYD

© 2019 Spraying Systems Co. All rights reserved. Full protection of law claimed under Universal Copyright and Berne Conventions and other applicable national and international laws.